

FEATURES:

- RoHS compliant
- High efficiency up to 78%
- Remote On/Off Control
- 8 pin SIP package
- Operating temperature -40°C to +85°C
- Continuous Short circuit protection
- Wide 2:1 input range
- Input / Output Isolation 1000 & 3000VDC



Models
Single Output

Model	Input Voltage (V)	Output Voltage (V)	Output Current max (mA)	Isolation (VDC)	Capacitor Load (µF)	Efficiency
AM2G-0503SZ	4.5-9	3.3	500	1000	3300	67
AM2G-0505SZ	4.5-9	5	400	1000	3300	66
AM2G-0507SZ	4.5-9	7.2	278	1000	470	66
AM2G-0509SZ	4.5-9	9	222	1000	470	68
AM2G-0512SZ	4.5-9	12	167	1000	470	70
AM2G-0515SZ	4.5-9	15	133	1000	470	70
AM2G-0518SZ	4.5-9	18	111	1000	220	68
AM2G-0524SZ	4.5-9	24	83	1000	220	68
AM2G-1203SZ	9-18	3.3	500	1000	3300	66
AM2G-1205SZ	9-18	5	400	1000	3300	75
AM2G-1207SZ	9-18	7.2	278	1000	470	75
AM2G-1209SZ	9-18	9	222	1000	470	75
AM2G-1212SZ	9-18	12	167	1000	470	77
AM2G-1215SZ	9-18	15	133	1000	470	77
AM2G-1218SZ	9-18	18	111	1000	220	75
AM2G-1224SZ	9-18	24	83	1000	220	75
AM2G-2403SZ	18-36	3.3	500	1000	3300	69
AM2G-2405SZ	18-36	5	400	1000	3300	75
AM2G-2407SZ	18-36	7.2	278	1000	470	75
AM2G-2409SZ	18-36	9	222	1000	470	77
AM2G-2412SZ	18-36	12	167	1000	470	78
AM2G-2415SZ	18-36	15	133	1000	470	78
AM2G-2418SZ	18-36	18	111	1000	220	77
AM2G-2424SZ	18-36	24	83	1000	220	77
AM2G-4803SZ	36-72	3.3	500	1000	3300	62
AM2G-4805SZ	36-72	5	400	1000	3300	70
AM2G-4807SZ	36-72	7.2	278	1000	470	70
AM2G-4809SZ	36-72	9	222	1000	470	72
AM2G-4812SZ	36-72	12	167	1000	470	76
AM2G-4815SZ	36-72	15	133	1000	470	76
AM2G-4818SZ	36-72	18	111	1000	220	74
AM2G-4824SZ	36-72	24	83	1000	220	74
AM2G-0503SH30Z	4.5-9	3.3	500	3000	3300	67
AM2G-0505SH30Z	4.5-9	5	400	3000	3300	66
AM2G-0507SH30Z	4.5-9	7.2	278	3000	470	66
AM2G-0509SH30Z	4.5-9	9	222	3000	470	68
AM2G-0512SH30Z	4.5-9	12	167	3000	470	70
AM2G-0515SH30Z	4.5-9	15	133	3000	470	70
AM2G-0518SH30Z	4.5-9	18	111	3000	220	68
AM2G-0524SH30Z	4.5-9	24	83	3000	220	68
AM2G-1203SH30Z	9-18	3.3	500	3000	3300	66
AM2G-1205SH30Z	9-18	5	400	3000	3300	75
AM2G-1207SH30Z	9-18	7.2	278	3000	470	75
AM2G-1209SH30Z	9-18	9	222	3000	470	75
AM2G-1212SH30Z	9-18	12	167	3000	470	77
AM2G-1215SH30Z	9-18	15	133	3000	470	77

Models

Single Output (continued)

Model	Input Voltage (V)	Output Voltage(V)	Output Current max (mA)	Isolation (VDC)	Capacitor Load (μF)	Efficiency
AM2G-1218SH30Z	9-18	18	111	3000	220	75
AM2G-1224SH30Z	9-18	24	83	3000	220	75
AM2G-2403SH30Z	18-36	3.3	500	3000	3300	69
AM2G-2405SH30Z	18-36	5	400	3000	3300	75
AM2G-2407SH30Z	18-36	7.2	278	3000	470	75
AM2G-2409SH30Z	18-36	9	222	3000	470	77
AM2G-2412SH30Z	18-36	12	167	3000	470	78
AM2G-2415SH30Z	18-36	15	133	3000	470	78
AM2G-2418SH30Z	18-36	18	111	3000	220	77
AM2G-2424SH30Z	18-36	24	83	3000	220	77
AM2G-4803SH30Z	36-72	3.3	500	3000	3300	62
AM2G-4805SH30Z	36-72	5	400	3000	3300	70
AM2G-4807SH30Z	36-72	7.2	278	3000	470	70
AM2G-4809SH30Z	36-72	9	222	3000	470	72
AM2G-4812SH30Z	36-72	12	167	3000	470	76
AM2G-4815SH30Z	36-72	15	133	3000	470	76
AM2G-4818SH30Z	36-72	18	111	3000	220	74
AM2G-4824SH30Z	36-72	24	83	3000	220	74

Models

Dual Output

Model	Input Voltage (V)	Output Voltage (V)	Output current max (mA)	Isolation (VDC)	Capacitor Load (μF)	Efficiency (%)
AM2G-0503DZ	4.5-9	±3.3	±250	1000	±1000	68
AM2G-0505DZ	4.5-9	±5	±200	1000	±1000	70
AM2G-0507DZ	4.5-9	±7.2	±139	1000	±470	70
AM2G-0509DZ	4.5-9	±9	±111	1000	±470	71
AM2G-0512DZ	4.5-9	±12	±83	1000	±470	75
AM2G-0515DZ	4.5-9	±15	±67	1000	±470	75
AM2G-0518DZ	4.5-9	±18	±56	1000	±220	75
AM2G-0524DZ	4.5-9	±24	±42	1000	±220	75
AM2G-1203DZ	9-18	±3.3	±250	1000	±1000	70
AM2G-1205DZ	9-18	±5	±200	1000	±1000	73
AM2G-1207DZ	9-18	±7.2	±139	1000	±470	74
AM2G-1209DZ	9-18	±9	±111	1000	±470	76
AM2G-1212DZ	9-18	±12	±83	1000	±470	78
AM2G-1215DZ	9-18	±15	±67	1000	±470	78
AM2G-1218DZ	9-18	±18	±56	1000	±220	78
AM2G-1224DZ	9-18	±24	±42	1000	±220	78
AM2G-2403DZ	18-36	±3.3	±250	1000	±1000	71
AM2G-2405DZ	18-36	±5	±200	1000	±1000	76
AM2G-2407DZ	18-36	±7.2	±139	1000	±470	76
AM2G-2409DZ	18-36	±9	±111	1000	±470	77
AM2G-2412DZ	18-36	±12	±83	1000	±470	78
AM2G-2415DZ	18-36	±15	±67	1000	±470	77
AM2G-2418DZ	18-36	±18	±56	1000	±220	77
AM2G-2424DZ	18-36	±24	±42	1000	±220	78
AM2G-4803DZ	36-72	±3.3	±250	1000	±1000	70
AM2G-4805DZ	36-72	±5	±200	1000	±1000	75
AM2G-4807DZ	36-72	±7.2	±139	1000	±470	75
AM2G-4809DZ	36-72	±9	±111	1000	±470	76
AM2G-4812DZ	36-72	±12	±83	1000	±470	78
AM2G-4815DZ	36-72	±15	±67	1000	±470	78

Models
Dual Output (continued)

Model	Input Voltage (V)	Output Voltage (V)	Output current max (mA)	Isolation (VDC)	Capacitor Load (μF)	Efficiency (%)
AM2G-4818DZ	36-72	±18	±56	1000	±220	78
AM2G-4824DZ	36-72	±24	±42	1000	±220	78
AM2G-0503DH30Z	4.5-9	±3.3	±250	3000	±1000	65
AM2G-0505DH30Z	4.5-9	±5	±200	3000	±1000	70
AM2G-0507DH30Z	4.5-9	±7.2	±139	3000	±470	70
AM2G-0509DH30Z	4.5-9	±9	±111	3000	±470	71
AM2G-0512DH30Z	4.5-9	±12	±83	3000	±470	75
AM2G-0515DH30Z	4.5-9	±15	±67	3000	±470	75
AM2G-0518DH30Z	4.5-9	±18	±56	3000	±220	75
AM2G-0524DH30Z	4.5-9	±24	±42	3000	±220	75
AM2G-1203DH30Z	9-18	±3.3	±250	3000	±1000	67
AM2G-1205DH30Z	9-18	±5	±200	3000	±1000	73
AM2G-1207DH30Z	9-18	±7.2	±139	3000	±470	74
AM2G-1209DH30Z	9-18	±9	±111	3000	±470	76
AM2G-1212DH30Z	9-18	±12	±83	3000	±470	78
AM2G-1215DH30Z	9-18	±15	±67	3000	±470	78
AM2G-1218DH30Z	9-18	±18	±56	3000	±220	78
AM2G-1224DH30Z	9-18	±24	±42	3000	±220	78
AM2G-2403DH30Z	18-36	±3.3	±250	3000	±1000	68
AM2G-2405DH30Z	18-36	±5	±200	3000	±1000	76
AM2G-2407DH30Z	18-36	±7.2	±139	3000	±470	76
AM2G-2409DH30Z	18-36	±9	±111	3000	±470	77
AM2G-2412DH30Z	18-36	±12	±83	3000	±470	78
AM2G-2415DH30Z	18-36	±15	±67	3000	±470	77
AM2G-2418DH30Z	18-36	±18	±56	3000	±220	77
AM2G-2424DH30Z	18-36	±24	±42	3000	±220	78
AM2G-4803DH30Z	36-72	±3.3	±250	3000	±1000	67
AM2G-4805DH30Z	36-72	±5	±200	3000	±1000	75
AM2G-4807DH30Z	36-72	±7.2	±139	3000	±470	75
AM2G-4809DH30Z	36-72	±9	±111	3000	±470	76
AM2G-4812DH30Z	36-72	±12	±83	3000	±470	78
AM2G-4815DH30Z	36-72	±15	±67	3000	±470	78
AM2G-4818DH30Z	36-72	±18	±56	3000	±220	78
AM2G-4824DH30Z	36-72	±24	±42	3000	±220	78

Input Specifications

Parameters	Nominal	Typical	Maximum	Units
Voltage range	5	4.5-9		VDC
	12	9-18		
	24	18-36		
	48	36-72		
Filter	Capacitor			
Turn on Transient process time			350	ms
Start up time		200		ms
Absolute Maximum Rating	5 Vin	-0.7-12		VDC
	12 Vin	-0.7-24		
	24 Vin	-0.7-40		
	48 Vin	-0.7-80		
Peak Input Voltage time		100		ms
On/Off Control	ON – low or open (0Vdc to 0.8Vdc)			
	OFF – high (4.5Vdc to 15Vdc, OFF idle current:3.5mA to 15mA Max.)			

Isolation Specifications

Parameters	Conditions	Typical	Rated	Units
Tested I/O voltage	3 sec		1000 & 3000	VDC
Resistance		> 1000	Capacitance	

Output Specifications

Parameters	Conditions	Typical	Maximum	Units
Voltage accuracy		±2		%
Voltage balance	Dual Output	±1		%
Short Circuit protection		Continuous		
Short Circuit restart		Auto recovery		
Line voltage regulation	LL~HL	±0.5		%
Load voltage regulation	load 25~100%	±1		%
Temperature coefficient		±0.02		%/°C
Ripple & Noise*	At 20MHz Bandwidth	80		mV p-p
Rising time		50		ms

* The ripple and noise should be measured with connected 47µF capacitor and 0.1µF ceramic capacitor on the output of the converter.

General Specifications

Parameters	Conditions	Typical	Maximum	Units
Switching frequency	100% load	>100	650	KHz
Operating temperature		-40 to +85		°C
Storage temperature		-40 to +125		°C
Max Case temperature			+100	°C
Cooling		Free air convection		
Humidity			95	%
Case material		Non-conductive black plastic (UL94V-0 rated)		
Weight		4.5		g
Dimensions (L x W x H)		0.86 x 0.36 x 0.42 inch	21.85 x 9.20 x 10.60 mm	
MTBF		>2 732 000 hrs (MIL-HDBK -217F, Ground Benign, t=+25°C)		

NOTE: All specifications in this datasheet are measured at an ambient temperature of 25°C, humidity<75%, nominal input voltage and at rated output load unless otherwise specified.

Safety Specifications

Parameters	
Agency Approval	CE
Standards	EN55022 Class A,
	IEC61000-4-2, Perf. Criteria B
	IEC61000-4-3, Perf. Criteria A
	IEC61000-4-4, Perf. Criteria B (external 220uF/100V cap required)
	IEC61000-4-5, Perf. Criteria B (external 220uF/100V cap required)
	IEC61000-4-6, Perf. Criteria A
	IEC61000-4-8, Perf. Criteria A

Pin Out Specification

Pin	1000 & 3000VDC	
	Single	Dual
1	- V Input	- V Input
2	+ V Input	+ V Input
3	On/Off Control	On/Off Control
5	N.C.	N.C.
6	+ V Output	+ V Output
7	- V Output	Common
8	N.C.	- V Output

N.C.: Not Connected

Dimensions

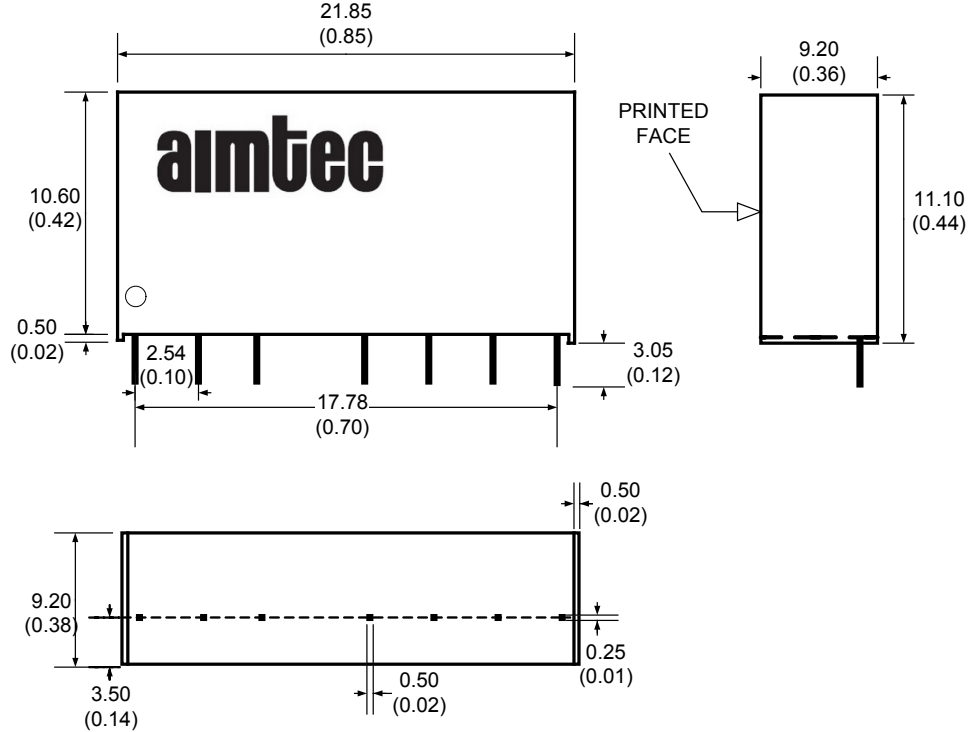

Control ON/OFF pin connection example:

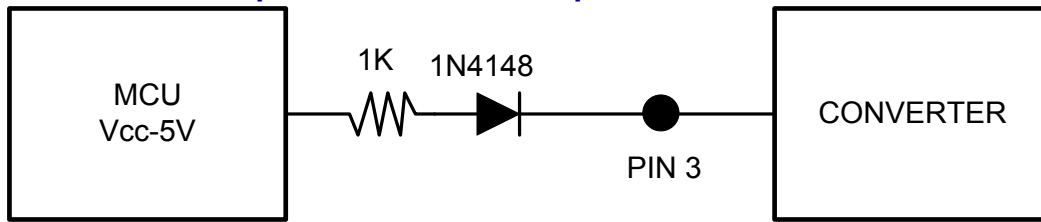

The voltage could be applied through a limiting resistor and a switching diode. The converter is in a low power mode during high level phase.

Conducted Emissions:

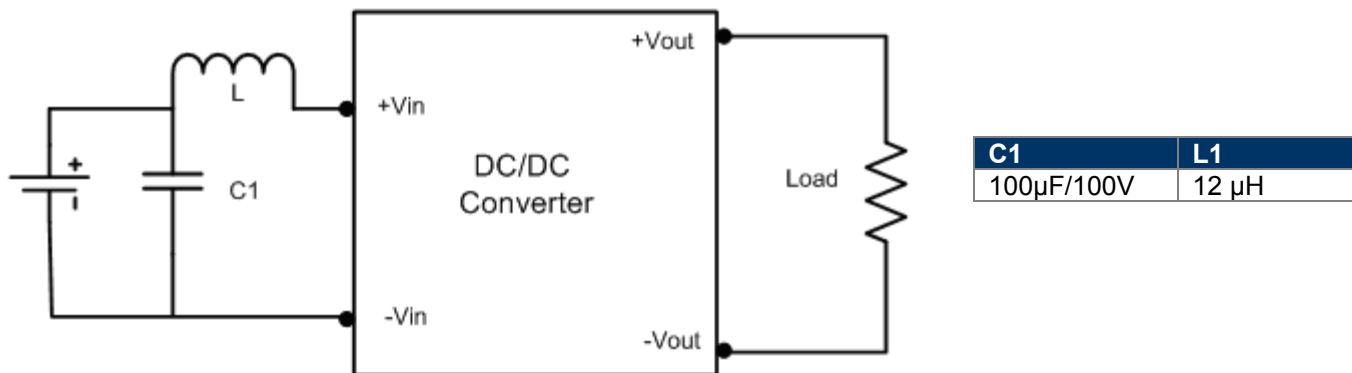

Surge:

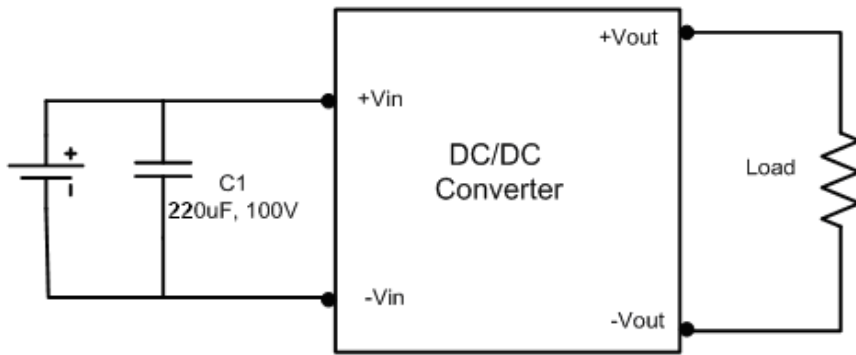

Derating

Free Air Convection

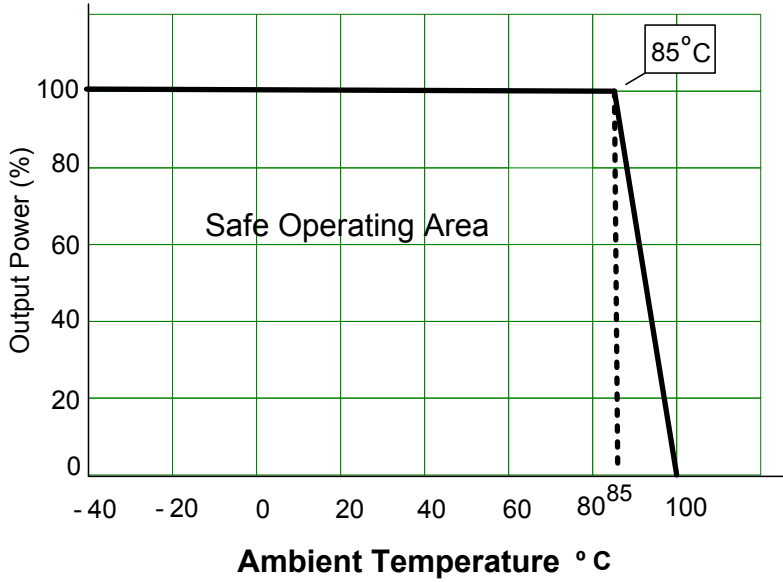

Switching Frequency vs Input Voltage and Load

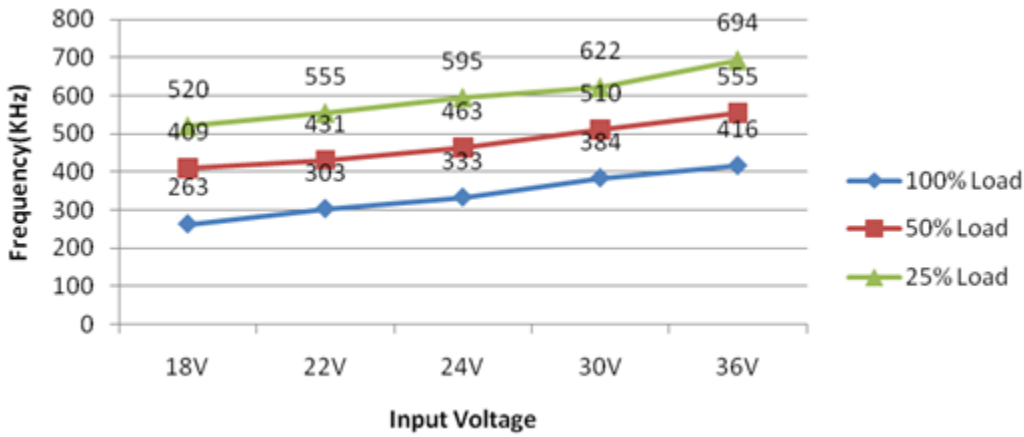

NOTE: **1.** Datasheets are updated as needed and as such, specifications are subject to change without notice. Once printed or downloaded, datasheets are no longer controlled by Aimtec; refer to www.aimtec.com for the most current product specifications. **2.** Product labels shown, including safety agency certifications on labels, may vary based on the date manufactured. **3.** Mechanical drawings and specifications are for reference only. **4.** All specifications are measured at an ambient temperature of 25°C, humidity<75%, nominal input voltage and at rated output load unless otherwise specified. **5.** Aimtec may not have conducted destructive testing or chemical analysis on all internal components and chemicals at the time of publishing this document. CAS numbers and other limited information are considered proprietary and may not be available for release. **6.** This product is not designed for use in critical life support systems, equipment used in hazardous environments, nuclear control systems or other such applications which necessitate specific safety and regulatory standards other the ones listed in this datasheet. **7.** Warranty is in accordance with Aimtec's standard Terms of Sale available at www.aimtec.com.