

LOW DROPOUT VOLTAGE REGULATOR

FEATURES

- High Voltage Precision at $\pm 2.0\%$ or ± 60 mV
- Very Low Quiescent Current
- Very Low Dropout Voltage
- Reverse Voltage Protection
- Miniature Package (SOT23-3)
- Short Circuit Protection
- High Ripple Rejection
- Can use Multilayer Ceramic Capacitors

DESCRIPTION

The TK715xx is a low dropout linear regulator housed in a small SOT23-3 package, rated at 400 mW. An internal PNP transistor is used to achieve a low dropout voltage of 105 mV (typ.) at 50 mA load current. This device offers high precision output voltage of $\pm 2.0\%$ or ± 60 mV. The TK715xx has a very low quiescent current of 25 μ A (typ.) at no load. The low quiescent current and dropout voltage make this part ideal for battery powered applications. The internal reverse bias protection eliminates the requirement for a reverse voltage protection diode, saving cost and board space. The high 60 dB ripple rejection and low noise provide enhanced performance for critical applications.

APPLICATIONS

- Battery Powered Systems
- Cellular Telephones
- Pagers
- Personal Communications Equipment
- Portable Instrumentation
- Portable Consumer Equipment
- Radio Control Systems
- Toys
- Low Voltage Systems

ORDERING INFORMATION

TK715□□ASCL

Voltage Code

Tape/ Reel Code

Temp. Code

Package Code

VOLTAGE CODE	TEMPERATURE CODE	TAPE/REEL CODE
15 = 1.5 V	C -30 to +80 °C	L: Tape Left
16 = 1.6 V		
17 = 1.7 V	PACKAGE CODE	
18 = 1.8 V	S : SOT-23-3	
19 = 1.9 V		
20 = 2.0 V		
21 = 2.1 V		
22 = 2.2 V		
23 = 2.3 V		
24 = 2.4 V		
25 = 2.5 V		
26 = 2.6 V		
27 = 2.7 V		
28 = 2.8 V		
29 = 2.9 V		
30 = 3.0 V		
31 = 3.1 V		
32 = 3.2 V		
33 = 3.3 V		
34 = 3.4 V		
35 = 3.5 V		
36 = 3.6 V		
37 = 3.7 V		
38 = 3.8 V		
39 = 3.9 V		
40 = 4.0 V		
41 = 4.1 V		
42 = 4.2 V		
43 = 4.3 V		
44 = 4.4 V		
45 = 4.5 V		
46 = 4.6 V		
47 = 4.7 V		
48 = 4.8 V		
49 = 4.9 V		
50 = 5.0 V		
60 = 6.0 V		
70 = 7.0 V		
80 = 8.0 V		
90 = 9.0 V		

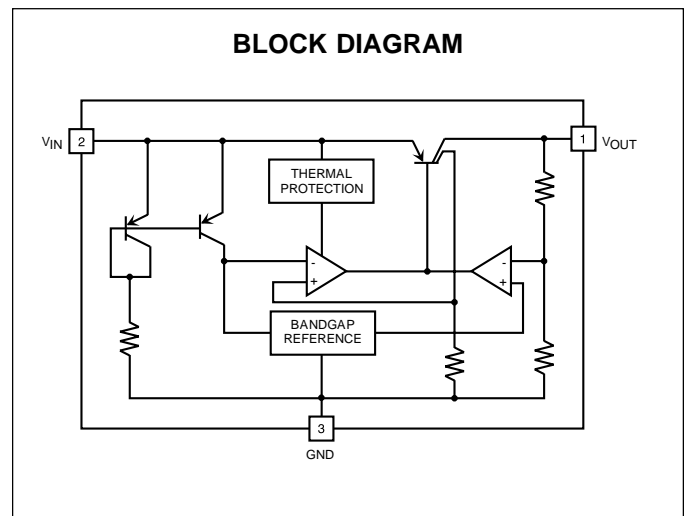
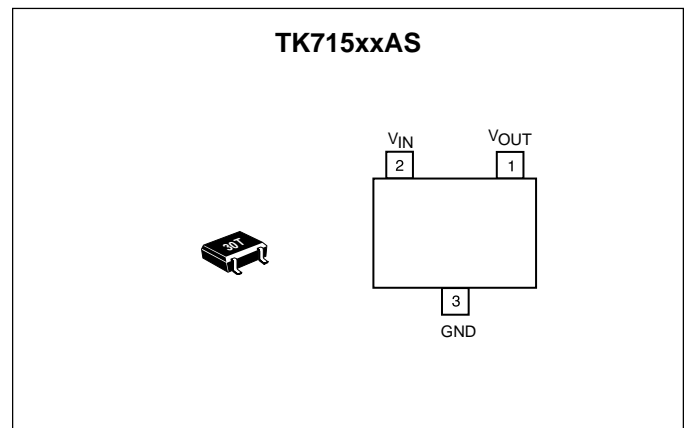

TK715xxAS

ABSOLUTE MAXIMUM RATINGS ($V_{OUT} \leq 5.0\text{ V}$)

Supply Voltage	-0.4 to 19 V	Operating Temperature (Ambient)	-30 to +80 °C
Power Dissipation (Note 1)	400 mW	Max. Operating Temperature (Junction)	125 °C
Reverse Bias	8 V	Operating Voltage Range	1.8 to 18.0 V
Short Circuit Current	170 mA	Junction Temperature	150 °C
Storage Temperature (Ambient)	-55 to +150 °C	Lead Soldering Temperature (10 s)	235 °C

TK715xx ELECTRICAL CHARACTERISTICS ($V_{OUT} \leq 5.0\text{ V}$)

Test conditions: $V_{IN} = V_{OUT(TYP)} + 1\text{ V}$, $T_A = 25\text{ °C}$, unless otherwise specified.

SYMBOL	PARAMETER	TEST CONDITIONS	MIN	TYP	MAX	UNITS
I_Q	Quiescent Current	$I_{OUT} = 0\text{ mA}$		25	45	μA
I_{GND}	Ground Pin Current	$I_{OUT} = 15\text{ mA}$		300	500	μA
V_{OUT}	Output Voltage	$I_{OUT} = 5\text{ mA}$	See Table 1			V
Line Reg	Line Regulation	$V_{IN} = V_{OUT(TYP)} + 1\text{ V}$ to $V_{OUT(TYP)} + 6\text{ V}$		3	12	mV
Load Reg	Load Regulation	$I_{OUT} = 5$ to 100 mA , (Note 2)		18	36	mV
V_{DROP}	Dropout Voltage (Note 5)	$I_{OUT} = 50\text{ mA}$		0.105	0.18	V
		$I_{OUT} = 100\text{ mA}$, $2.4\text{ V} \leq V_{OUT} \leq 5.0\text{ V}$		0.16	0.28	V
		$I_{OUT} = 100\text{ mA}$, $2.1\text{ V} \leq V_{OUT} \leq 2.4\text{ V}$		0.16	0.30	V
$I_{OUT(MAX)}$	Continuous Output Current		115	155		mA
		$1.8\text{ V} \leq V_{in} \leq 2.1\text{ V}$ (Note 3)	70	90		
RR	Ripple Rejection	(Note 4)		60		dB
$\Delta V_{OUT} / \Delta T$	Temperature Coefficient	$I_{OUT} = 5\text{ mA}$		30		ppm/°C

Note 1: Power dissipation is 400 mW when mounted as recommended. Derate at 3.2 mW/°C for operation above 25 °C.

Note 2: Refer to "Definition of Terms."

Note 3: Please refer to the Applications Section for more information.

Note 4: Ripple rejection is measured at $V_R = 200\text{ mVrms}$, $V_{IN} = V_{OUT(TYP)} + 2\text{ V}$, $I_{OUT} = 10\text{ mA}$, $C_L = 2.2\text{ }\mu\text{F}$, $f = 100\text{ Hz}$.

Note 5: The minimum operating voltage for V_{IN} can be 1.8 V. Also, the minimum voltage required for V_{IN} is $V_{IN} = V_{DROP} + V_{OUT}$. As a result, operating at $V_{OUT} \leq 2.0\text{ V}$ at the minimum input operating voltage is not preferred.

Gen. Note: Parameters with min. or max. values are 100% tested at $T_A = 25\text{ °C}$.

ABSOLUTE MAXIMUM RATINGS ($V_{OUT} \geq 5.1$ V)

Supply Voltage	-0.4 to 19 V	Operating Temperature (Ambient)	-30 to +80 °C
Power Dissipation (Note 1)	400 mW	Max. Operating Temperature (Junction)	125 °C
Reverse Bias	8 V	Operating Voltage Range	1.8 to 18 V
Short Circuit Current	170 mA	Junction Temperature	150 °C
Storage Temperature (Ambient)	-55 to +150 °C	Lead Soldering Temperature (10 s)	235 °C

TK715xx ELECTRICAL CHARACTERISTICS ($V_{OUT} \geq 5.1$ V)

Test conditions: $V_{IN} = V_{OUT(TYP)} + 1$ V, $T_A = 25$ °C, unless otherwise specified.

SYMBOL	PARAMETER	TEST CONDITIONS	MIN	TYP	MAX	UNITS
I_Q	Quiescent Current	$I_{OUT} = 0$ mA		32	60	μ A
I_{GND}	Ground Pin Current	$I_{OUT} = 15$ mA		300	500	μ A
V_{OUT}	Output Voltage	$I_{OUT} = 5$ mA	See Table 1			V
Line Reg	Line Regulation	$V_{IN} = V_{OUT(TYP)} + 1$ V to $V_{OUT(TYP)} + 6$ V or Max 18 V		3	12	mV
Load Reg	Load Regulation	$I_{OUT} = 5$ to 100 mA, (Note 2)		35	80	mV
V_{DROD}	Dropout Voltage	$I_{OUT} = 50$ mA		0.105	0.18	V
		$I_{OUT} = 100$ mA		0.160	0.28	V
$I_{OUT(MAX)}$	Continuous Output Current		115	155		mA
RR	Ripple Rejection	(Note 3)		60		dB
$\Delta V_{OUT} / \Delta T$	Temperature Coefficient	$I_{OUT} = 5$ mA		30		ppm/°C

Note 1: Power dissipation is 400 mW when mounted as recommended. Derate at 3.2 mW/°C for operation above 25 °C.

Note 2: Refer to "Definition of Terms."

Note 3: Ripple rejection is measured at $V_R = 200$ mVrms, $V_{IN} = V_{OUT(TYP)} + 2$ V, $I_{OUT} = 10$ mA, $C_L = 2.2$ μ F, $f = 100$ Hz.

Gen. Note: Parameters with min. or max. values are 100% tested at $T_A = 25$ °C.

TK715xxAS

TK715xxAS ELECTRICAL CHARACTERISTICS TABLE 1

Output Voltage	Voltage Code	V _{OUT(MIN)}	V _{OUT(MAX)}	Test Voltage
1.5 V	15	1.440 V	1.560 V	2.5 V
1.6 V	16	1.540 V	1.660 V	2.6 V
1.7 V	17	1.640 V	1.760 V	2.7 V
1.8 V	18	1.740 V	1.860 V	2.8 V
1.9 V	19	1.840 V	1.960 V	2.9 V
2.0 V	20	1.940 V	2.060 V	3.0 V
2.1 V	21	2.040 V	2.160 V	3.1 V
2.2 V	22	2.140 V	2.260 V	3.2 V
2.3 V	23	2.240 V	2.360 V	3.3 V
2.4 V	24	2.340 V	2.460 V	3.4 V
2.5 V	25	2.440 V	2.560 V	3.5 V
2.6 V	26	2.540 V	2.660 V	3.6 V
2.7 V	27	2.640 V	2.760 V	3.7 V
2.8 V	28	2.740 V	2.860 V	3.8 V
2.9 V	29	2.840 V	2.960 V	3.9 V
3.0 V	30	2.940 V	3.060 V	4.0 V
3.1 V	31	3.040 V	3.160 V	4.1 V
3.2 V	32	3.140 V	3.260 V	4.2 V
3.3 V	33	3.240 V	3.360 V	4.3 V
3.4 V	34	3.340 V	3.460 V	4.4 V

Output Voltage	Voltage Code	V _{OUT(MIN)}	V _{OUT(MAX)}	Test Voltage
3.5 V	35	3.440 V	3.560 V	4.5 V
3.6 V	36	3.530 V	3.670 V	4.6 V
3.7 V	37	3.630 V	3.770 V	4.7 V
3.8 V	38	3.730 V	3.870 V	4.8 V
3.9 V	39	3.830 V	3.970 V	4.9 V
4.0 V	40	3.930 V	4.070 V	5.0 V
4.1 V	41	4.030 V	4.170 V	5.1 V
4.2 V	42	4.130 V	4.270 V	5.2 V
4.3 V	43	4.230 V	4.370 V	5.3 V
4.4 V	44	4.330 V	4.470 V	5.4 V
4.5 V	45	4.430 V	4.570 V	5.5 V
4.6 V	46	4.530 V	4.670 V	5.6 V
4.7 V	47	4.630 V	4.770 V	5.7 V
4.8 V	48	4.730 V	4.870 V	5.8 V
4.9 V	49	4.830 V	4.970 V	5.9 V
5.0 V	50	4.930 V	5.070 V	6.0 V
6.0 V	60	5.880 V	6.120 V	7.0 V
7.0 V	70	6.860 V	7.140 V	8.0 V
8.0 V	80	7.840 V	8.160 V	9.0 V
9.0 V	90	8.820 V	9.180 V	10.0 V

TEST CIRCUIT

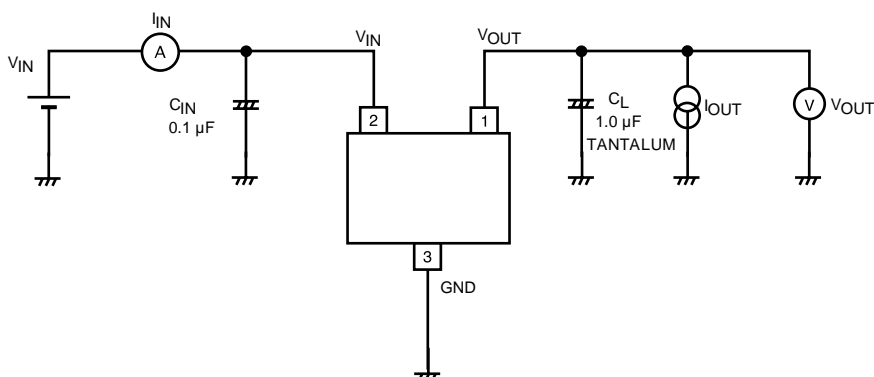

TYPICAL PERFORMANCE CHARACTERISTICS

$T_A = 25\text{ }^\circ\text{C}$, unless otherwise specified.

LOAD REGULATION

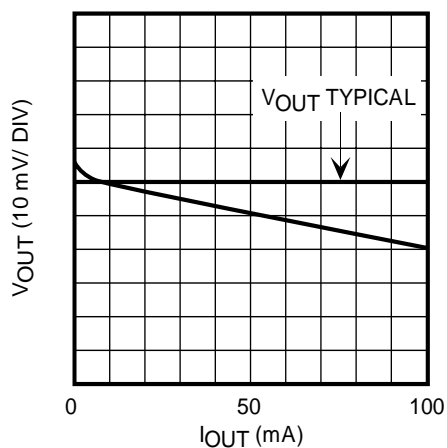

SHORT CIRCUIT CURRENT

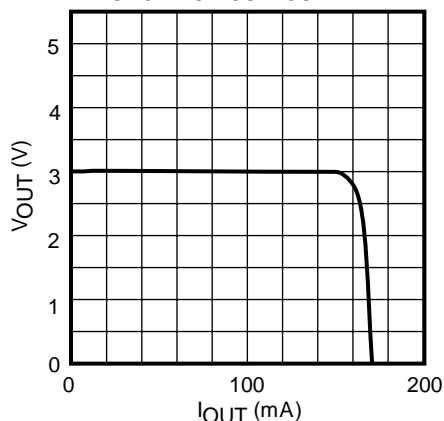

OUTPUT VOLTAGE vs. INPUT VOLTAGE

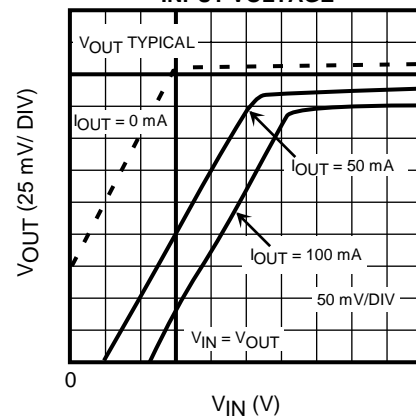

LINE REGULATION

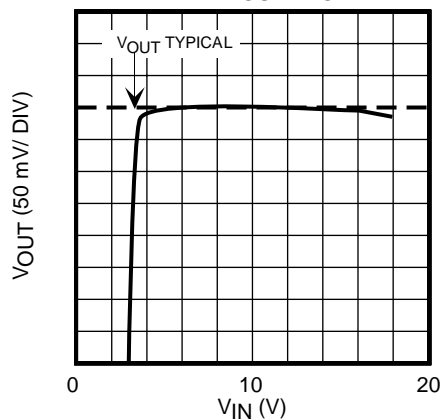

REVERSE BIAS CURRENT RANGE

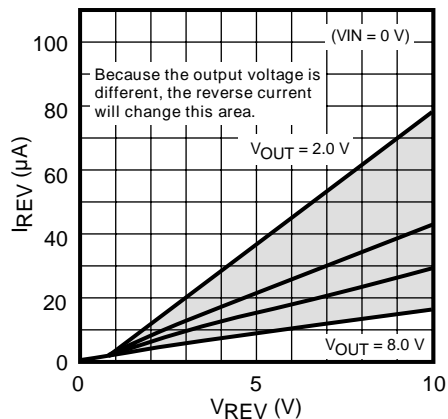

INPUT CURRENT vs. INPUT VOLTAGE

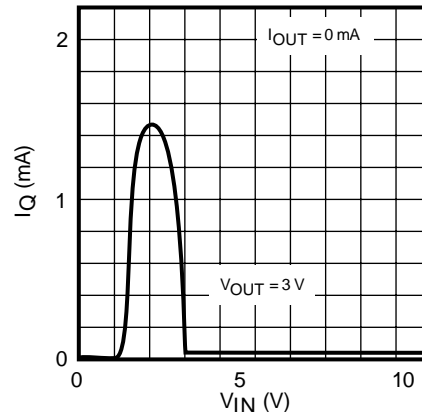

TYPICAL PERFORMANCE CHARACTERISTICS (CONT.)

$T_A = 25\text{ }^\circ\text{C}$, unless otherwise specified.

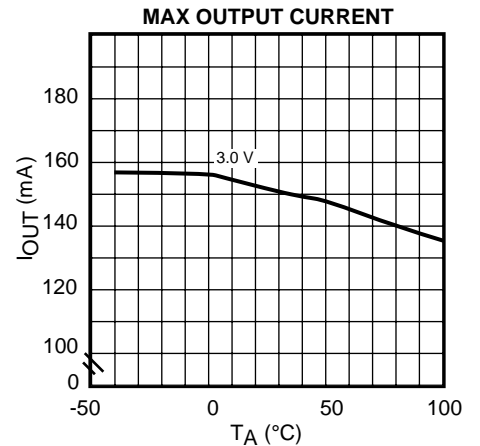
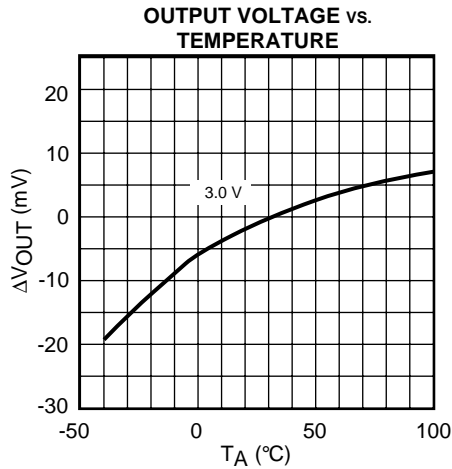
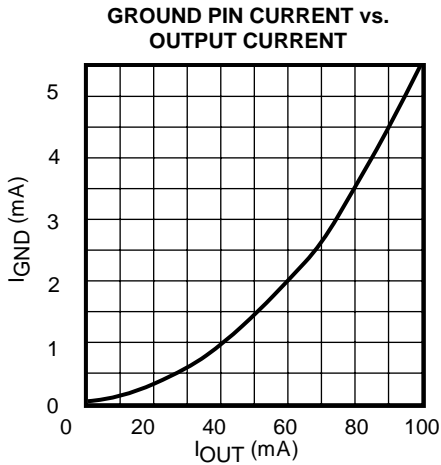
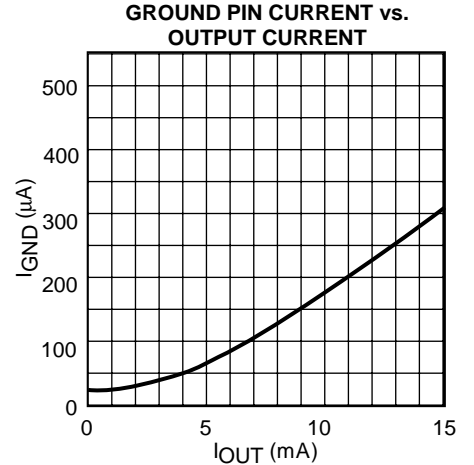
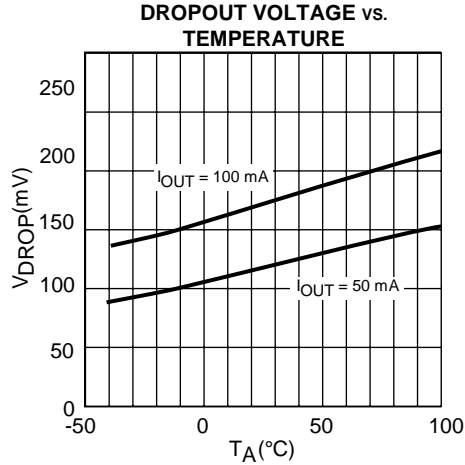
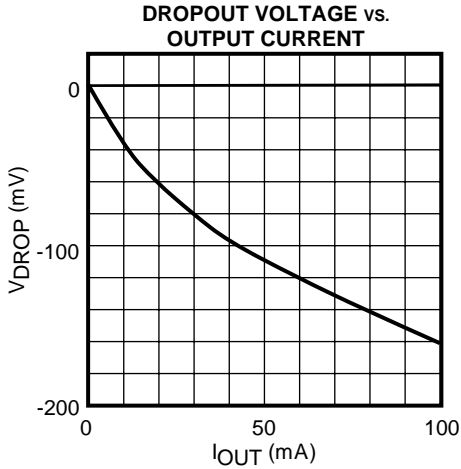

Ripple Rejection

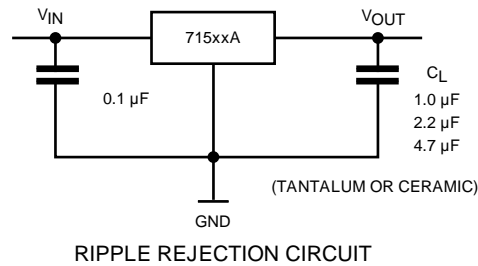
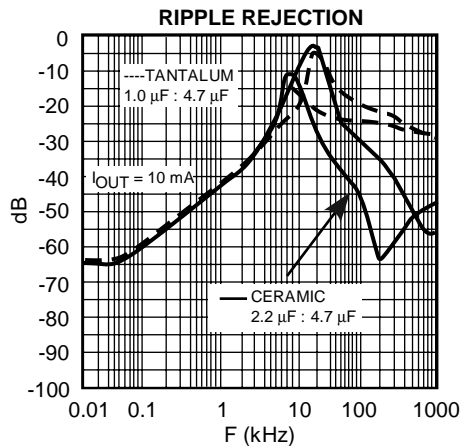

TYPICAL PERFORMANCE CHARACTERISTICS (CONT.)

$T_A = 25\text{ }^\circ\text{C}$, unless otherwise specified.

Output Noise

NOISE LEVEL (TK71530A) vs.
OUTPUT CURRENT

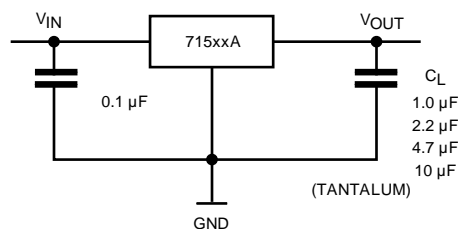
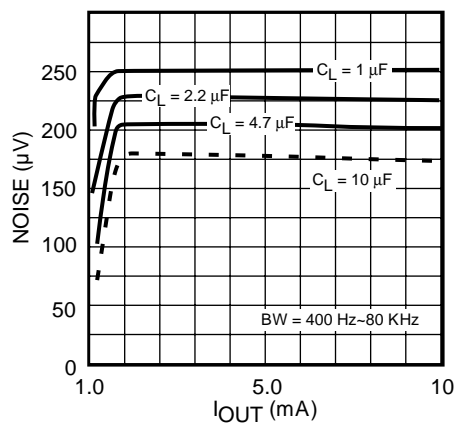

OUTPUT NOISE CIRCUIT

Load & Line Response

LINE VOLTAGE STEP RESPONSE

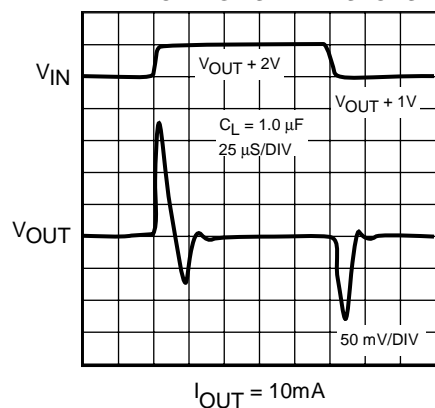

LOAD CURRENT
STEP RESPONSE

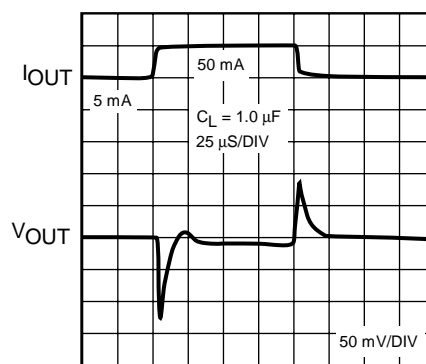

Note: To improve the load and line transient response, increase the value of the output capacitor.

DEFINITION AND EXPLANATION OF TECHNICAL TERMS

OUTPUT VOLTAGE (V_{OUT})

The output voltage is specified with $V_{IN} = (V_{OUT(TYP)} + 1 \text{ V})$ and $I_{OUT} = 5 \text{ mA}$.

DROPOUT VOLTAGE (V_{DROPO})

The dropout voltage is the difference between the input voltage and the output voltage at which point the regulator starts to fall out of regulation. Below this value, the output voltage will fall as the input voltage is reduced. It is dependent upon the load current and the junction temperature.

CONTINUOUS OUTPUT CURRENT (I_{OUT})

Normal operating output current. This is limited by package power dissipation.

LINE REGULATION (Line Reg)

Line regulation is the ability of the regulator to maintain a constant output voltage as the input voltage changes. The line regulation is specified as the input voltage is changed from $V_{IN} = V_{OUT(TYP)} + 1 \text{ V}$ to $V_{IN} = V_{OUT(TYP)} + 6 \text{ V}$ or $V_{IN} = \text{max } 18 \text{ V}$.

LOAD REGULATION (Load Reg)

Load regulation is the ability of the regulator to maintain a constant output voltage as the load current changes. It is a pulsed measurement to minimize temperature effects with the input voltage set to $V_{IN} = V_{OUT(TYP)} + 1 \text{ V}$. The load regulation is specified under the output current step condition 5 mA to 100 mA.

QUIESCENT CURRENT (I_Q)

The quiescent current is the current which flows through the ground terminal under no load conditions ($I_{OUT} = 0 \text{ mA}$).

GROUND CURRENT (I_{GND})

Ground current is the current which flows through the ground pin(s). It is defined as $I_{IN} - I_{OUT}$, excluding control current.

RIPPLE REJECTION RATIO (RR)

Ripple rejection is the ability of the regulator to attenuate the ripple content of the input voltage at the output. It is specified with 200 mVrms, 100 Hz superimposed on the input voltage, where $V_{IN} = V_{OUT(TYP)} + 2.0 \text{ V}$. The output decoupling capacitor is set to 2.2 μF and the load current is set to 10 mA. Ripple rejection is the ratio of the ripple content of the output vs. the input and is expressed in dB.

REVERSE VOLTAGE PROTECTION

Reverse voltage protection prevents damage due to the output voltage being higher than the input voltage. This fault condition can occur when the output capacitor remains charged and the input is reduced to zero, or when an external voltage higher than the input voltage is applied to the output side.

REDUCTION OF OUTPUT NOISE

Although the architecture of the Toko regulators are designed to minimize semiconductor noise, further reduction can be achieved by the selection of external components. The obvious solution is to increase the size of the output capacitor. Please note that several parameters are affected by the value of the capacitors and bench testing is recommended when deviating from standard values.

PACKAGE POWER DISSIPATION (P_D)

This is the power dissipation level at which the thermal sensor is activated. The IC contains an internal thermal sensor which monitors the junction temperature. When the junction temperature exceeds the monitor threshold of 150 °C, the IC is shut down. The junction temperature rises as the difference between the input power ($V_{IN} \times I_{IN}$) and the output power ($V_{OUT} \times I_{OUT}$) increases. The rate of temperature rise is greatly affected by the mounting pad configuration on the PCB, the board material, and the ambient temperature. When the IC mounting has good thermal conductivity, the junction temperature will be low even if the power dissipation is great. When mounted on the recommended mounting pad, the power dissipation of the SOT23-3 is increased to 400 mW. For operation at ambient temperatures over 25 °C, the power dissipation of the SOT23-3 device should be derated at 3.2 mW/°C. To

DEFINITION AND EXPLANATION OF TECHNICAL TERMS (CONT.)

determine the power dissipation for shutdown when mounted, attach the device on the actual PCB and deliberately increase the output current (or raise the input voltage) until the thermal protection circuit is activated. Calculate the power dissipation of the device by subtracting the output power from the input power. These measurements should allow for the ambient temperature of the PCB. The value obtained from $P_D / (150\text{ °C} - T_A)$ is the derating factor. The PCB mounting pad should provide maximum thermal conductivity in order to maintain low device temperatures. As a general rule, the lower the temperature, the better the reliability of the device. The thermal resistance when mounted is expressed as follows:

$$T_j = \theta_{jA} \times P_D + T_A$$

For Toko ICs, the internal limit for junction temperature is 150 °C. If the ambient temperature (T_A) is 25 °C, then:

$$150\text{ °C} = \theta_{jA} \times P_D + 25\text{ °C}$$

$$\theta_{jA} = 125\text{ °C} / P_D$$

P_D is the value when the thermal sensor is activated. A simple way to determine P_D is to calculate $V_{IN} \times I_{IN}$ when the output side is shorted. Input current gradually falls as temperature rises. You should use the value when thermal equilibrium is reached.

The range of usable currents can also be found from the graph below.

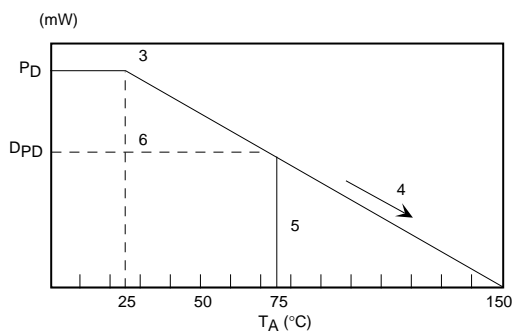

Procedure:

- 1) Find P_D

- 2) P_{D1} is taken to be $P_D \times (\sim 0.8 - 0.9)$
- 3) Plot P_{D1} against 25 °C
- 4) Connect P_{D1} to the point corresponding to the 150 °C with a straight line.
- 5) In design, take a vertical line from the maximum operating temperature (e.g., 75 °C) to the derating curve.
- 6) Read off the value of P_D against the point at which the vertical line intersects the derating curve. This is taken as the maximum power dissipation, D_{PD} .

The maximum operating current is:

$$I_{OUT} = (D_{PD} / (V_{IN(MAX)} - V_{OUT}))$$

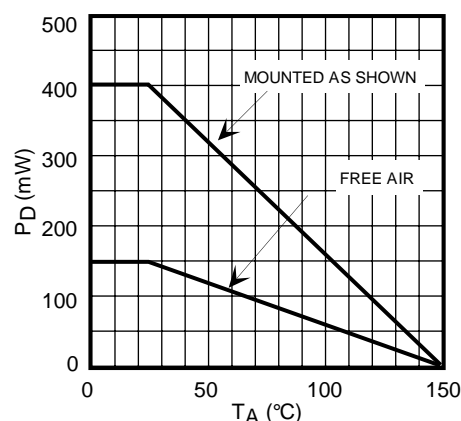

SOT23-3 POWER DISSIPATION CURVE

APPLICATION INFORMATION

INPUT-OUTPUT CAPACITORS

Linear regulators require input and output capacitors in order to maintain regulator loop stability. The output capacitor should be selected within the Equivalent Series Resistance (ESR) range as shown in the graphs below for stable operation. The output capacitor C_L can be reduced as the output voltage is increased. However, the output noise will increase as C_L is reduced, so the largest value of C_L possible is recommended ($C_L = 4.7 \mu\text{F}$ or more).

Note: It is very important to check the selected manufacturers electrical characteristics (capacitance and ESR) over temperature.

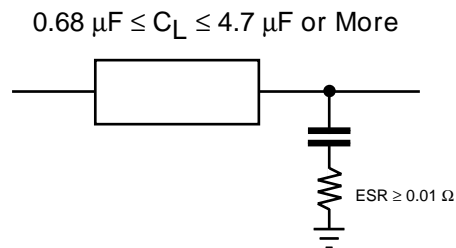
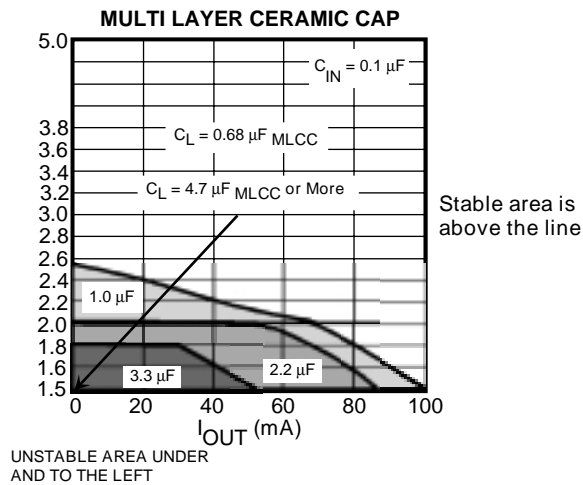

Range which can be used: $V_{\text{OUT}} \geq 2.8\text{V}$ $I_{\text{OUT}} = 1 \text{ mA} \sim \text{Max}$, MULTI LAYER CERAMIC CAP. $\geq 0.68 \mu\text{F}$
 $V_{\text{OUT}} \geq 2.0\text{V}$ $I_{\text{OUT}} = 1 \text{ mA} \sim \text{Max}$, MULTI LAYER CERAMIC CAP. $\geq 1.0 \mu\text{F}$
 $V_{\text{OUT}} \geq 1.5\text{V}$ $I_{\text{OUT}} = 1 \text{ mA} \sim \text{Max}$, MULTI LAYER CERAMIC CAP. $\geq 4.7 \mu\text{F}$

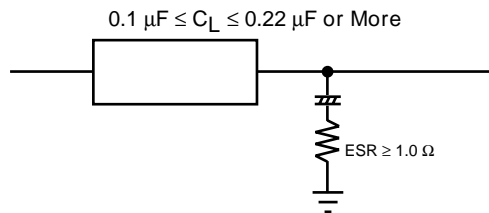
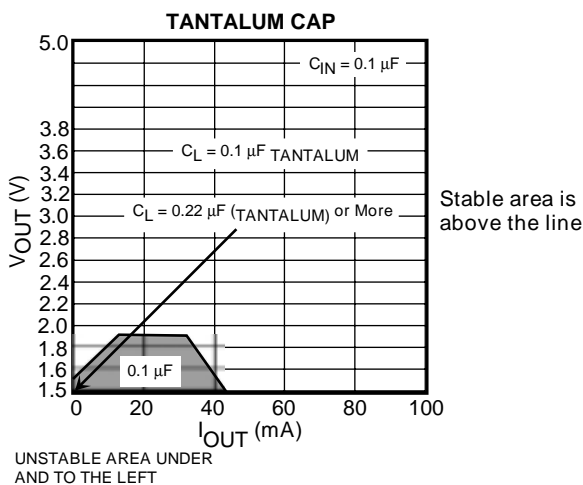

Range which can be used: $V_{\text{OUT}} \geq 1.9\text{V}$ $I_{\text{OUT}} = 1 \text{ mA} \sim \text{Max}$, TANTALUM CAP. $\geq 0.1 \mu\text{F}$ (CERAMIC CAP $0.22 \mu\text{F} + 2.2\Omega$)
 Capacitor used for evaluation: $V_{\text{OUT}} \geq 1.5\text{V}$ $I_{\text{OUT}} = 1 \text{ mA} \sim \text{Max}$, TANTALUM CAP. $\geq 0.22 \mu\text{F}$ (CERAMIC CAP $0.22 \mu\text{F} + 2.2\Omega$)

APPLICATION INFORMATION (CONT)

INPUT-OUTPUT CAPACITORS (CONT)

OUTPUT NOISE IMPROVEMENT

An RC filter can be added to the output stage of the regulator to reduce output noise when the input voltage is high and the output current only makes small changes. Select a regulator with a slightly higher output voltage because the final output voltage will be reduced by the RC filter. If the output current does make a large change, the output voltage will change. The following table shows output noise, and output voltage for various values of R_{OUT} and C_{OUT} using a 3.5 V device.

$V_{IN} = 4.0 \text{ V}$, $C_{IN} = 10 \mu\text{F}$ (aluminum electrolytic), $C_{OUT} =$ (see table), $R_{OUT} =$ (see table)

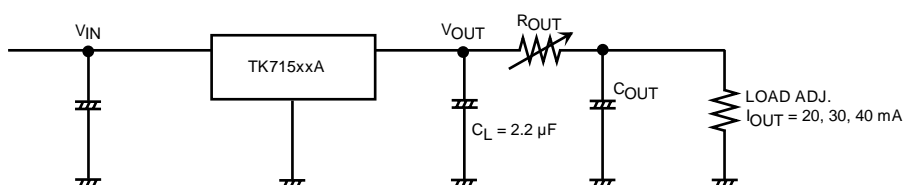

MEASUREMENT CONDITION			OUTPUT SIDE CAPACITOR (C_{OUT})			UNITS	
I_{OUT}	R_{OUT}	V_{OUT}	10 μF	47 μF	100 μF	μV	C_{OUT}
$I_{OUT} = 20 - 40 \text{ mA}$	0	3.500 V	210 μV	150 μV	130 μV	RMS	NOISE
20 mA	10 Ω	3.296 V	76 μV	50 μV	40 μV	RMS	
30 mA	6.8 Ω	3.287 V	88 μV	55 μV	48 μV	RMS	
40 mA	5.1 Ω	3.266 V	100 μV	60 μV	48 μV	RMS	

RIPPLE REJECTION RATIO

An RC filter can be added to the input stage of the regulator to increase the ripple rejection when the input voltage is high. Even if the resulting difference between V_{IN} at the regulator (after the RC filter) and V_{OUT} is small the TK71533AS will output a stable voltage. The voltage dropped across the RC filter depends on the value of the input ripple noise. Select the value of R_{IN} such that the lowest value of V_{IN} plus the ripple noise after the RC filter (peak to peak) is the output voltage plus 0.2 V.

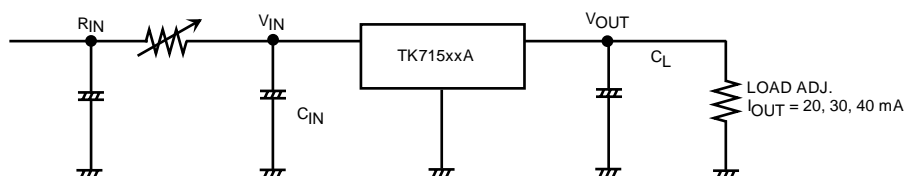

APPLICATION INFORMATION (CONT)

R(*) MAG -17.98 dB 10 dB/ -50.00 dB
 B(*) B -41.05 dB 10 dB/ -50.00 dB

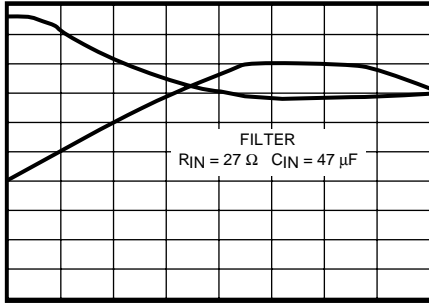

START: 100 Hz STOP: 1 MHz
 OUT (B): -20.00 dBm ST: AUTO x1 1 MΩ
 IRG: 26 dBm RBW: 30 kHz VBW: 38 kHz

R(*) MAG -57.78 dB 10 dB/ -50.00 dB
 B(*) B -41.05 dB 10 dB/ -50.00 dB

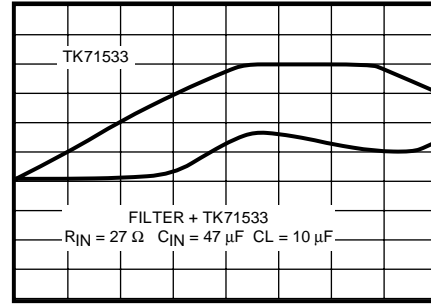

START: 100 Hz STOP: 1 MHz
 OUT (B): -20.00 dBm ST: AUTO x1 1 MΩ
 IRG: 26 dBm RBW: 30 kHz VBW: 38 kHz

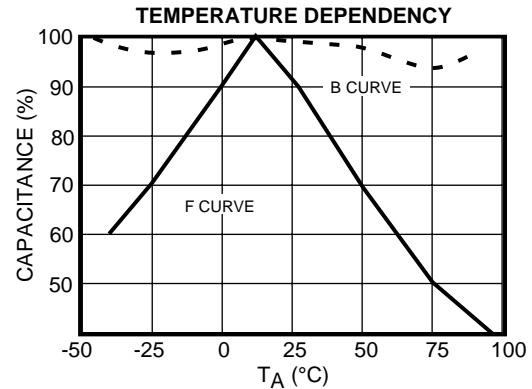
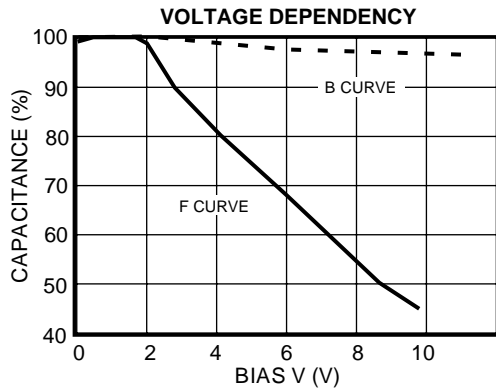

In general, a ceramic capacitor has a voltage and temperature dependence. Parts should be selected with consideration of the voltage and temperature used. The "B" characteristic curves are recommended.

APPLICATION INFORMATION (CONT.)

BOARD LAYOUT

The copper pattern should be as large as possible. Power dissipation is 400 mW for the SOT23-3, derated at 3.2 mW/°C for operation above $T_A = 25^\circ\text{C}$ ($\theta_{ja} = 312^\circ\text{C/W}$)

The internal reverse bias protection eliminates the requirement for a reverse voltage protection diode. This saves both cost and board space.

SOT23-3 BOARD LAYOUT

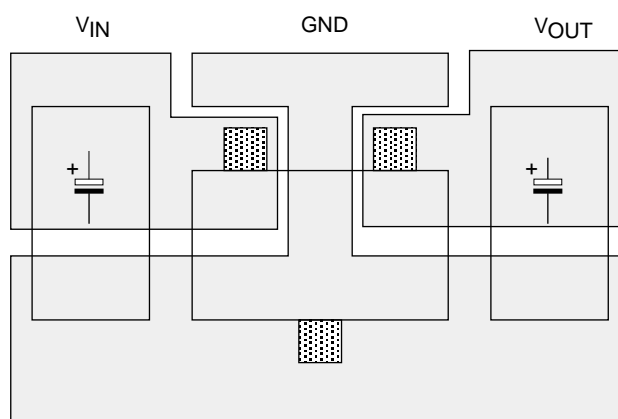

APPLICATION INFORMATION (CONT.)

REVERSE VOLTAGE PROTECTION

The internal reverse bias protection eliminates the requirement for a reverse voltage protection diode. This saves both cost and board space.

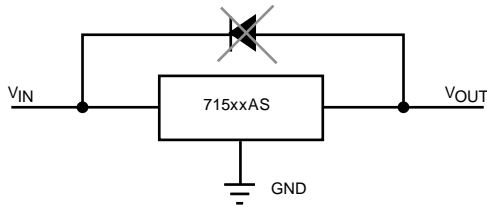

Another reverse voltage protection technique is illustrated below. The extra diode and extra capacitor are not necessary with the TK715xxA. The high output voltage accuracy is maintained because the diode forward voltage variations over temperature and load current have been eliminated.

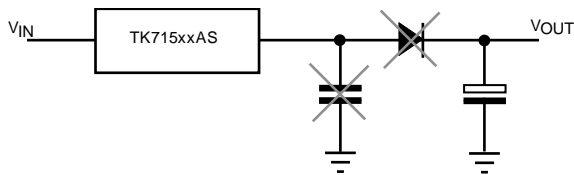

PARALLEL OPERATION

The series resistor R is put in the input line of the low output voltage regulator in order to prevent overdissipation. The voltage dropped across the resistor reduces the large input-to-output voltage across the regulator, reducing the power dissipation in the device.

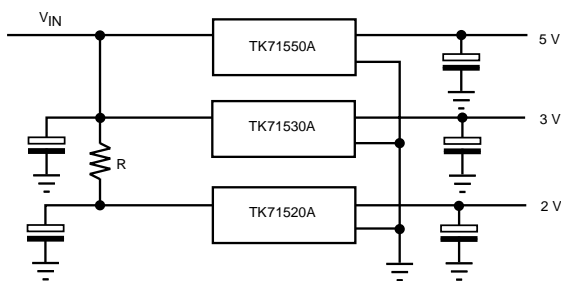

SWITCHING OPERATION

Even though the input voltages or the output voltages are different, the outputs of the TK715xxA regulators can be connected together, and the output voltages switched. If two or more TK715xxA regulators are turned ON simultaneously, the highest output voltage will be present.

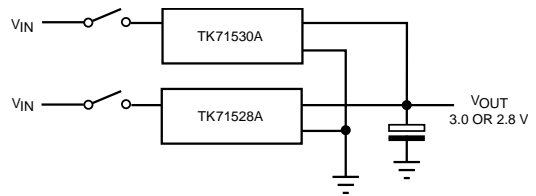

CURRENT BOOST OPERATION

The output current can be increased by connecting an external PNP transistor as shown below. The output current capability depends upon the H_{fe} of the external transistor. Note: The TK715xxA internal short circuit protection and thermal sensor do not protect the external transistor.

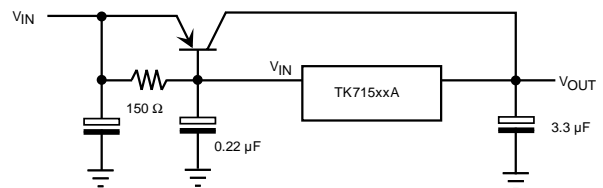

PACKAGE OUTLINE

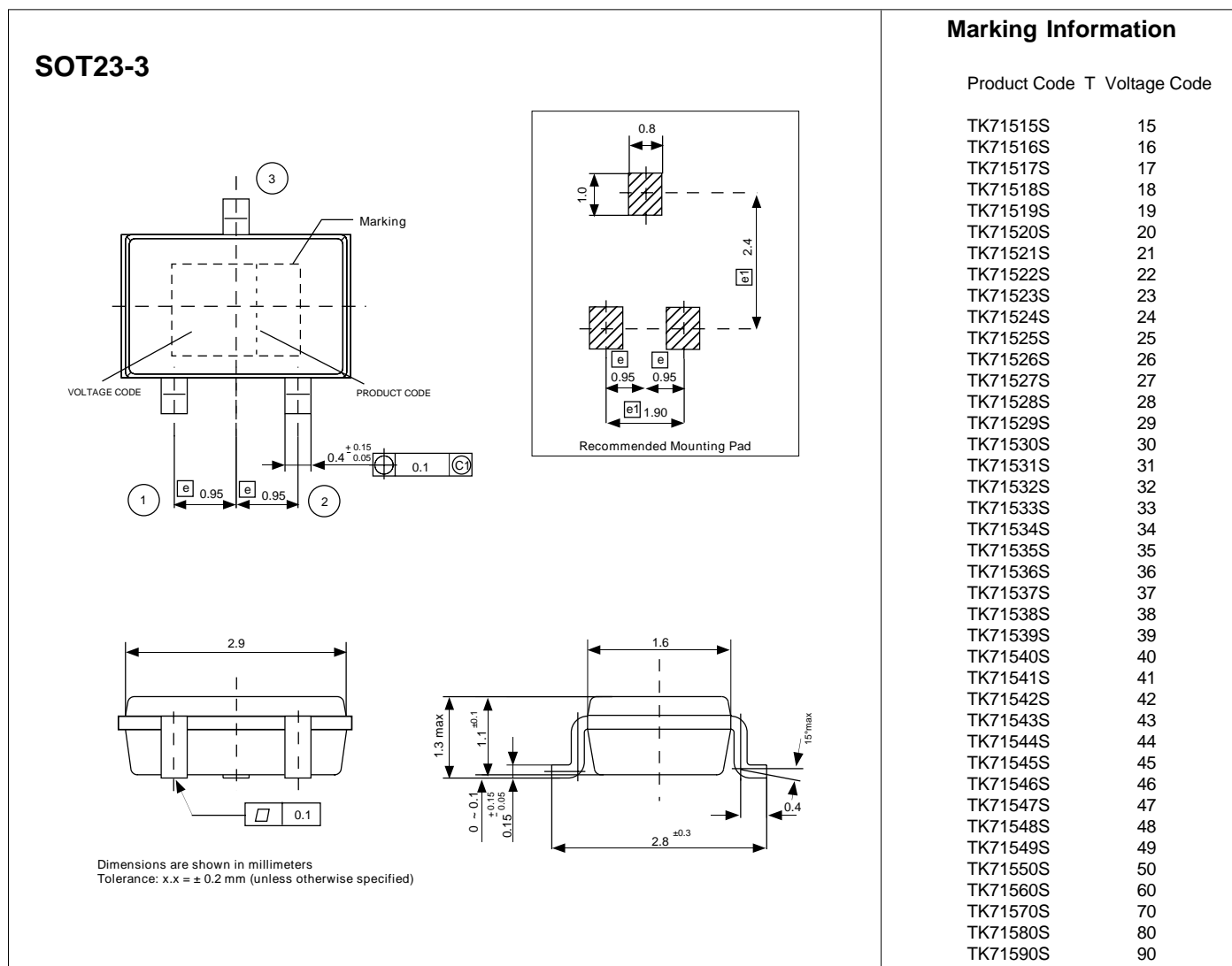

Toko America, Inc. Headquarters
1250 Feehanville Drive, Mount Prospect, Illinois 60056
Tel: (847) 297-0070 Fax: (847) 699-7864

TOKO AMERICA REGIONAL OFFICES

Midwest Regional Office
Toko America, Inc.
1250 Feehanville Drive
Mount Prospect, IL 60056
Tel: (847) 297-0070
Fax: (847) 699-7864

Western Regional Office
Toko America, Inc.
2480 North First Street, Suite 260
San Jose, CA 95131
Tel: (408) 432-8281
Fax: (408) 943-9790

Semiconductor Technical Support
Toko Design Center
4755 Forge Road
Colorado Springs, CO 80907
Tel: (719) 528-2200
Fax: (719) 528-2375

Visit our Internet site at <http://www.tokoam.com>

The information furnished by TOKO, Inc. is believed to be accurate and reliable. However, TOKO reserves the right to make changes or improvements in the design, specification or manufacture of its products without further notice. TOKO does not assume any liability arising from the application or use of any product or circuit described herein, nor for any infringements of patents or other rights of third parties which may result from the use of its products. No license is granted by implication or otherwise under any patent or patent rights of TOKO, Inc.

March 2001 TOKO, Inc.

© 1999 Toko, Inc.
All Rights Reserved

IC-xxx-TK715xx
079800.0K

Page 15
Printed in the USA