

PLEASE CHECK WWW.MOLEX.COM FOR LATEST PART INFORMATION

Part Number: [0643191201](#)
Status: **Active**
Overview: [cmc_connectors](#)
Description: CMC Wire Cap for 32 Circuits, CMC Receptacle Mat Sealed

Documents:

3D Model	Product Specification PS-64319-001 (PDF)
Drawing (PDF)	RoHS Certificate of Compliance (PDF)
Application Specification (PDF)	

General

Product Family	Crimp Housings
Series	64319
Comments	For left and right wire output
More Detailed Tech Information	Wire cap guides the wires from the connector either to the right or to the left
Overview	cmc_connectors
Product Name	CMC

Physical

Circuits (maximum)	0
Circuits Detail	Wire Cap 32 circuit
Color - Resin	Black
Gender	N/A
Glow-Wire Compliant	No
Keying to Mating Part	N/A
Lock to Mating Part	Yes
Material - Resin	Nylon
Number of Rows	0
Packaging Type	Carton
Panel Mount	No
Pitch - Mating Interface (in)	0.000 In
Pitch - Mating Interface (mm)	0.00 mm
Polarized to Mating Part	N/A
Stackable	No
Temperature Range - Operating	-40°C to +125°C

Material Info

Reference - Drawing Numbers

Application Specification	AS-64319-001, AS-98993-011
Packaging Specification	PK-64319-002
Product Specification	PS-64319-001
Sales Drawing	SD-64319-002, SD-98993-004

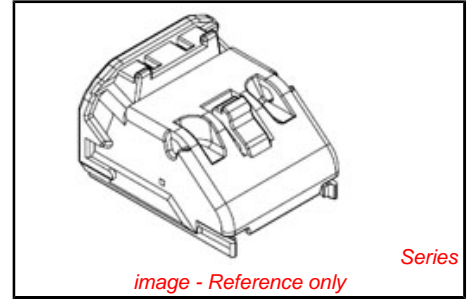

image - Reference only

EU RoHS

ELV and RoHS Compliant
REACH SVHC Contains SVHC: No
Halogen-Free Status
Halogen-Free

China RoHS



Need more information on product environmental compliance?

Email productcompliance@molex.com
 For a multiple part number RoHS Certificate of Compliance, [click here](#)

Please visit the [Contact Us](#) section for any non-product compliance questions.

Search Parts in this Series
[64319Series](#)

Mates With
[64319 CMC Receptacle](#)

Use With
[CMC CP Terminals 64322](#) , [64323](#). [CMC Wire Cap 643191201](#). [Sealing Plugs 643251010](#) , [643251023](#)

PLEASE CHECK WWW.MOLEX.COM FOR LATEST PART INFORMATION

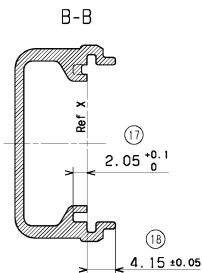
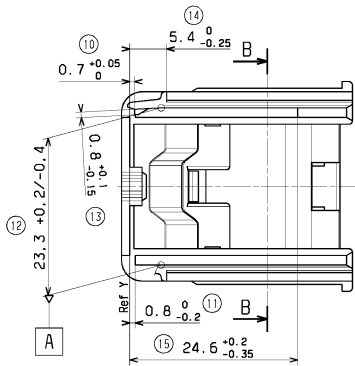
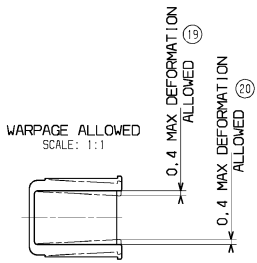

This hole accept a cable-tie maximum section of 3,2x1,2mm

MARKINGS

1	Supplier identification
2	Supplier part number
3	Date MONTH/YEAR
4	Material
5	Mould identification M1 ou M2
6	Print identification (number)
7	Revision level identification

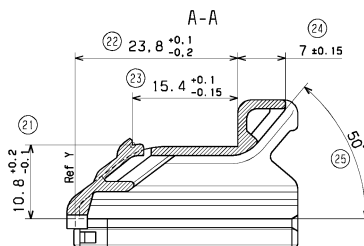
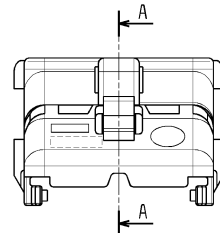
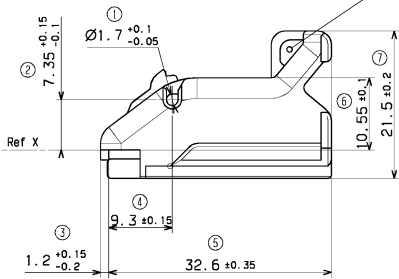
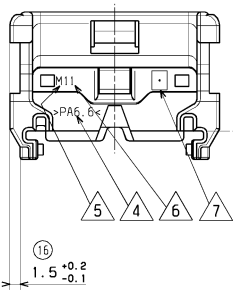

- NOTES
- 1-MATERIAL : PA 6.6 BLACK heat stabilized
 - 2-DELIVERED PRODUCT WEIGHT: 3.6 g
 - 3-RELATED COUNTERPART FEMALE CONNECTORS (32WAY)

SCALE 1:1

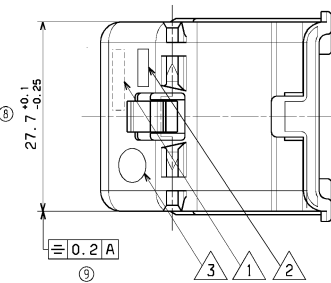
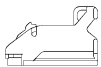

UPDATED DRAWING EC NO: 02006-0367 CD/DRWK: TBADARQUX 2008/05/16 CH/AD: PGRANDCL 2008/05/16 APPR: CBOUCHAN 2008/05/16 REV:	GENERAL TOLERANCES (UNLESS SPECIFIED)		DIMENSION STYLE MM ONLY		SCALE 2.5:1	DESIGN UNITS METRIC	FIRST ANGLE PROJECTION
	4 PLACES ± 3 PLACES ± 2 PLACES ± 1 PLACE ±	mm ± ± ±	INCH ± ± ±	DRAWN BY TBADARQUX	DATE 2007/07/16	TITLE WIRE CAP 32 WAY MAT SEAL VERSION	
DRAFT WHERE APPLICABLE MUST REMAIN WITHIN DIMENSIONS		MATERIAL NO. 0643191201		DOCUMENT NO. SD-64319-002		SHEET NO. 1 OF 1	

