

PLEASE CHECK WWW.MOLEX.COM FOR LATEST PART INFORMATION

Part Number: [0559320310](#)
Status: **Active**
Overview: [microclasp](#)
Description: 2.00mm (.079") Pitch MicroClasp™ Wire-to-Board Header, Single Row, Vertical, 3 Circuits, with PCB Locator

Documents:

3D Model	Product Specification PS-51382-004 (PDF)
Drawing (PDF)	RoHS Certificate of Compliance (PDF)

General

Product Family	PCB Headers
Series	55932
Application	Wire-to-Board
Overview	microclasp
Product Name	MicroClasp™

Physical

Breakaway	No
Circuits (Loaded)	3
Circuits (maximum)	3
Color - Resin	Natural
Durability (mating cycles max)	30
First Mate / Last Break	No
Glow-Wire Compliant	No
Guide to Mating Part	No
Keying to Mating Part	None
Lock to Mating Part	Yes
Material - Plating Mating	Tin
Material - Plating Termination	Tin
Material - Resin	Polyester
Number of Rows	1
Orientation	Vertical
PC Tail Length (in)	0.126 In
PC Tail Length (mm)	3.20 mm
PCB Locator	Yes
PCB Retention	Yes
PCB Thickness Recommended (in)	0.062 In
PCB Thickness Recommended (mm)	1.60 mm
Packaging Type	Tray
Pitch - Mating Interface (in)	0.079 In
Pitch - Mating Interface (mm)	2.00 mm
Shrouded	Fully
Stackable	No
Surface Mount Compatible (SMC)	No
Temperature Range - Operating	-25°C to +85°C
Termination Interface: Style	Through Hole

Electrical

Current - Maximum per Contact	3A
Voltage - Maximum	250V

Material Info

Reference - Drawing Numbers

Packaging Specification	SPK-55932-001
-------------------------	---------------

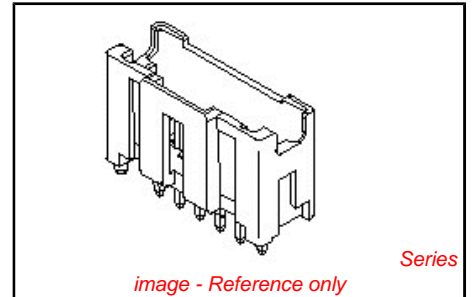

<p>EU RoHS ELV and RoHS Compliant REACH SVHC Contains SVHC: No Halogen-Free Status Not Halogen-Free</p>	<p>China RoHS</p>
--	--------------------------

Need more information on product environmental compliance?

Email productcompliance@molex.com
 For a multiple part number RoHS Certificate of Compliance, [click here](#)

Please visit the [Contact Us](#) section for any non-product compliance questions.

Search Parts in this Series
[55932Series](#)

Mates With
[51382 MicroClasp™ Wire-to-Board Receptacle Housing](#)

Product Specification

Sales Drawing

PS-51382-004, RPS-51382-006, RPS-51382-007,
RPS-51382-008, RPS-51382-009, RPS-51382-010,
RPS-51382-011, RPS-51382-012, RPS-51382-013,
RPS-51382-014
SD-55932-002

This document was generated on 05/25/2010

PLEASE CHECK WWW.MOLEX.COM FOR LATEST PART INFORMATION

10 9 8 7 6 5 4 3 2 1

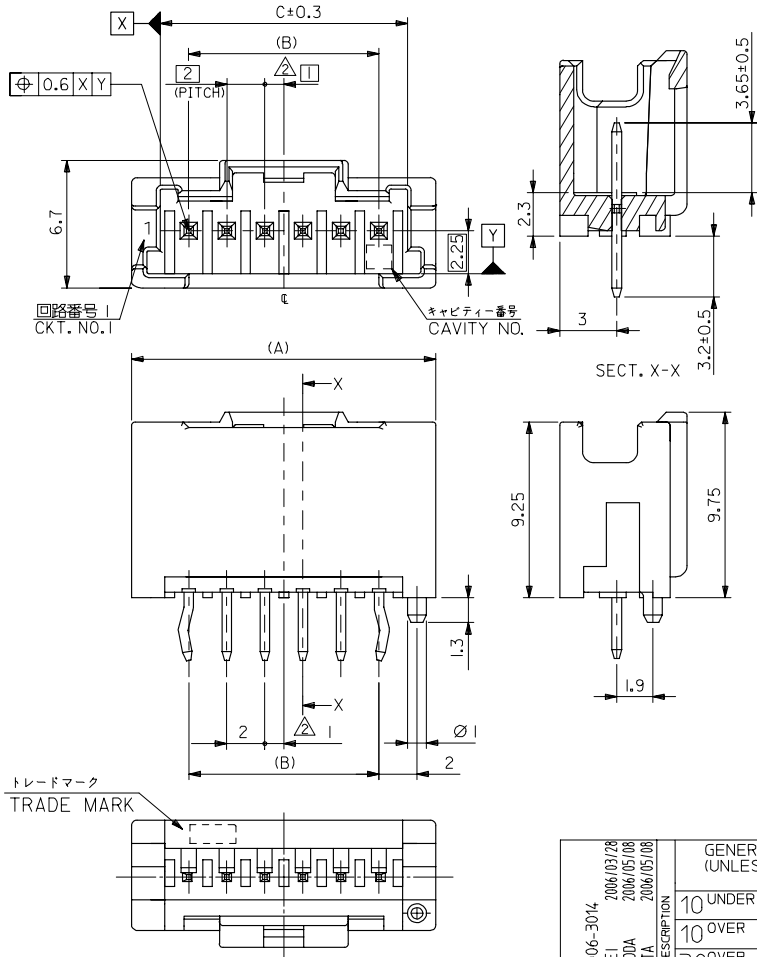

NOTE
 1. 嵌合相手：51382シリーズ
 △ 偶数極（列）に適用。
 3. キングは両外側の位置に付加。
 △ 製品番号 MATERIAL NO.

55932-****
 極数 CIRCUIT SIZE

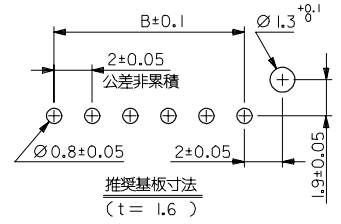

色 COLOR
10 自然色 (白) NATURAL (WHITE)
11 黒 BLACK
12 赤 RED
13 黄 YELLOW
14 青 BLUE
15 桃 PINK
16 緑 GREEN
17 茶 BROWN
18 橙 ORANGE
19 紫 VIOLET
41 灰 GRAY
43 螢光黄 FLUORESCENCE YELLOW
44 水 PALE BLUE
46 黄緑 YELLOWISH GREEN

31	28	34	55932-15**	15
29	26	32	55932-14**	14
27	24	30	55932-13**	13
25	22	28	55932-12**	12
23	20	26	55932-11**	11
21	18	24	55932-10**	10
19	16	22	55932-09**	9
17	14	20	55932-08**	8
15	12	18	55932-07**	7
13	10	16	55932-06**	6
11	8	14	55932-05**	5
9	6	12	55932-04**	4
7	4	10	55932-03**	3
5	2	8	55932-02**	2
C	B	A	MATERIAL NO. CKT.	

MATERIAL
 ピン : 黄銅、錫メッキ
 ハウジング : PBT

REVISED IEC NO.: J2006-3014 2006/03/28 DRAWN: HANBEI 2006/05/08 CHK: KATOYODA 2006/05/08 APPR: NUKITA 2006/05/08 H	GENERAL TOLERANCES (UNLESS SPECIFIED)	DIMENSION STYLE MM ONLY	SCALE ---	DESIGN UNITS METRIC	THIRD ANGLE PROJECTION
	10 UNDER ±0.2	DRAWN BY T. NIITSU	DATE '02/02/08	TITLE 2.0 W/B SINGLE CONN. PLUG HOUSING ASS'Y ST-LEAD FREE-	
	10 OVER 30 UNDER ±0.25	CHECKED BY K. ASAKAWA	DATE '03/06/12	MOLEX INCORPORATED	
	30 OVER ±0.3	APPROVED BY T. YAMAGUCHI	DATE '03/06/12	DOCUMENT NO. SD-55932-002	SHEET NO. 1 OF 2
ANGULAR ±3 °	DRAFT WHERE APPLICABLE MUST REMAIN WITHIN DIMENSIONS	SEE CHART	THIS DRAWING CONTAINS INFORMATION THAT IS PROPRIETARY TO MOLEX INCORPORATED AND SHOULD NOT BE USED WITHOUT WRITTEN PERMISSION		

10 9 8 7 6 5 4 3 2 1

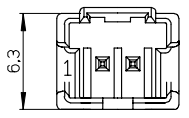
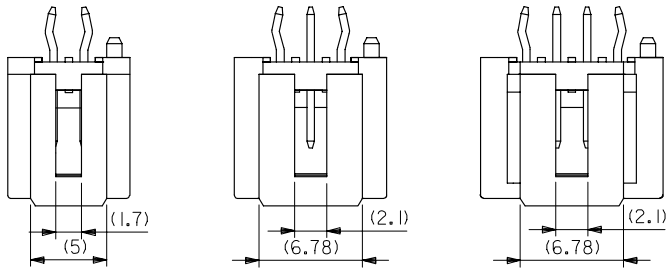

2 CIRCUIT

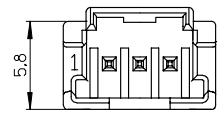

3 CIRCUIT

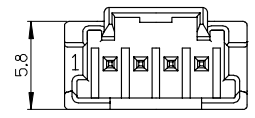

4 CIRCUIT 以上

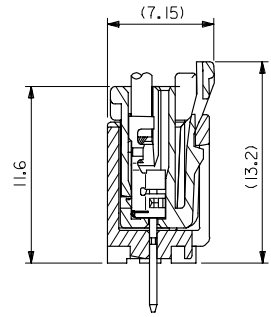

嵌合断面図

MODEL NO. : 55932-****

REVISED EC NO. J2006-3014 DRW:HWABEI 2006/03/28 CHK:KTOYODA 2006/05/08 APPR:NIKIITA 2006/05/08 H	GENERAL TOLERANCES (UNLESS SPECIFIED)		DIMENSION STYLE MM ONLY		SCALE ---	DESIGN UNITS METRIC	THIRD ANGLE PROJECTION
	10 UNDER	±0.2	DRAWN BY T.NIITSU	DATE '02/02/08	TITLE 2.0 W/B SINGLE CONN. PLUG HOUSING ASS'Y ST -LEAD FREE- MOLEX INCORPORATED		
	10 OVER 30 UNDER	±0.25	CHECKED BY K.ASAKAWA	DATE '03/06/12			
	30 OVER	±0.3	APPROVED BY T.YAMAGUCHI	DATE '03/06/12			
	ANGULAR ±3 °		MATERIAL NO.		DOCUMENT NO.		SHEET NO.
DRAFT WHERE APPLICABLE MUST REMAIN WITHIN DIMENSIONS		SEE CHART		SD-55932-002		2 OF 2	

THIS DRAWING CONTAINS INFORMATION THAT IS PROPRIETARY TO MOLEX INCORPORATED AND SHOULD NOT BE USED WITHOUT WRITTEN PERMISSION