

The RF Line VHF Power Amplifiers

... designed for 7.5 volt VHF power amplifier applications in industrial and commercial equipment primarily hand portable radios.

- MHW607-1: 136-150 MHz
- MHW607-2: 146-174 MHz
- MHW607-3: 174-195 MHz
- MHW607-4: 184-210 MHz
- Specified 7.5 Volt Characteristics:
 - RF Input Power = 1.0 mW (0 dBm)
 - RF Output Power = 7.0 Watts (MHW607-1,-2); 6.5 W (MHW607-3,-4)
 - Minimum Gain ($V_{Control} = 7.0 V$) = 38.5 dB
 - Harmonics = -40 dBc Max @ 2.0 f_o
- 50 Ω Input/Output Impedance
- Guaranteed Stability and Ruggedness
- Epoxy Glass PCB Construction Gives Consistent Performance and Reliability
- Circuit board photomaster available upon request by contacting RF Tactical Marketing in Phoenix, AZ.

MHW607-1
MHW607-2
MHW607-3
MHW607-4

7.0 W — 136 to 210 MHz
6.5 W — 174 to 210 MHz
VHF POWER
AMPLIFIERS

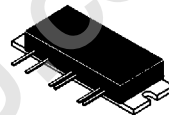

CASE 301K-02, STYLE 3

MAXIMUM RATINGS (Flange Temperature = 25°C)

Rating	Symbol	Value	Unit
DC Supply Voltage (Pins 2, 4, 5)	$V_{S1,2,3}$	9.0	Vdc
DC Control Voltage (Pin 3)	V_{Cont}	9.0	Vdc
RF Input Power	P_{in}	5.0	mW
RF Output Power ($V_{S1} = V_{S2} = V_{S3} = 9.0 V$)	P_{out}	10	W
Operating Case Temperature Range	T_C	-30 to +100	°C
Storage Temperature Range	T_{stg}	-30 to +100	°C

ELECTRICAL CHARACTERISTICS ($V_{S1} = V_{S2} = V_{S3} = 7.5 Vdc$, (Pins 2, 4, 5), $T_C = 25^\circ C$, 50 Ω System)

Characteristic	Symbol	Min	Max	Unit
Frequency Range MHW607-1 MHW607-2 MHW607-3 MHW607-4	—	136 146 174 184	150 174 195 210	MHz
Control Voltage ($P_{out} = 7.0 W$, $P_{in} = 1.0 mW$) ⁽¹⁾	V_{Cont}	0	7.0	Vdc
Quiescent Current ($V_{S1} = V_{S2} = V_{S3} = 7.5 Vdc$, $V_{Cont} = 7.0 Vdc$)	$I_{S1(q)} + I_{S2(q)}$	—	160	mA
Power Gain ($P_{out} = 7.0 W$, $V_{Cont} = 7.0 Vdc$)	G_p	38.5	—	dB
Efficiency ($P_{out} = 7.0 W$, $P_{in} = 1.0 mW$) ⁽¹⁾	η	40	—	%
Harmonics ($P_{out} = 7.0 W$) ⁽¹⁾ 2 f_o ($P_{in} = 1.0 mW$) 3 f_o	—	—	-40 -45	dBc
Input VSWR ($P_{out} = 7.0 W$, $P_{in} = 1.0 mW$, 50 Ω Ref. (1))	—	—	2.0:1	—
Load Mismatch ($V_{S1} = V_{S2} = V_{S3} = 9.0 Vdc$) VSWR = 20:1, $P_{out} = 8 W$, $P_{in} = 5.0 mW$) ⁽¹⁾	—	No Degradation in Power Output		
Stability ($P_{in} = 1.0-30 mW$, $V_{S1} = V_{S2} = V_{S3} = 6.0-9.0 Vdc$) P_{out} between 1.0 W and 10 W ⁽¹⁾ Load VSWR = 8:1	—	All spurious outputs more than 60 dB below desired signal		
Control Current ($V_{S1} = V_{S2} = V_{S3} = 7.5 V$, $P_{in} = 0 dBm$, V_{Cont} Set for $P_o = 7.0 W$)	—	—	325	mA

(1) Adjust V_{Cont} for specified P_{out} .

REV 6

MHW607-1 MHW607-2 MHW607-3 MHW607-4
2-78

MOTOROLA RF DEVICE DATA

6367254 0106442 560

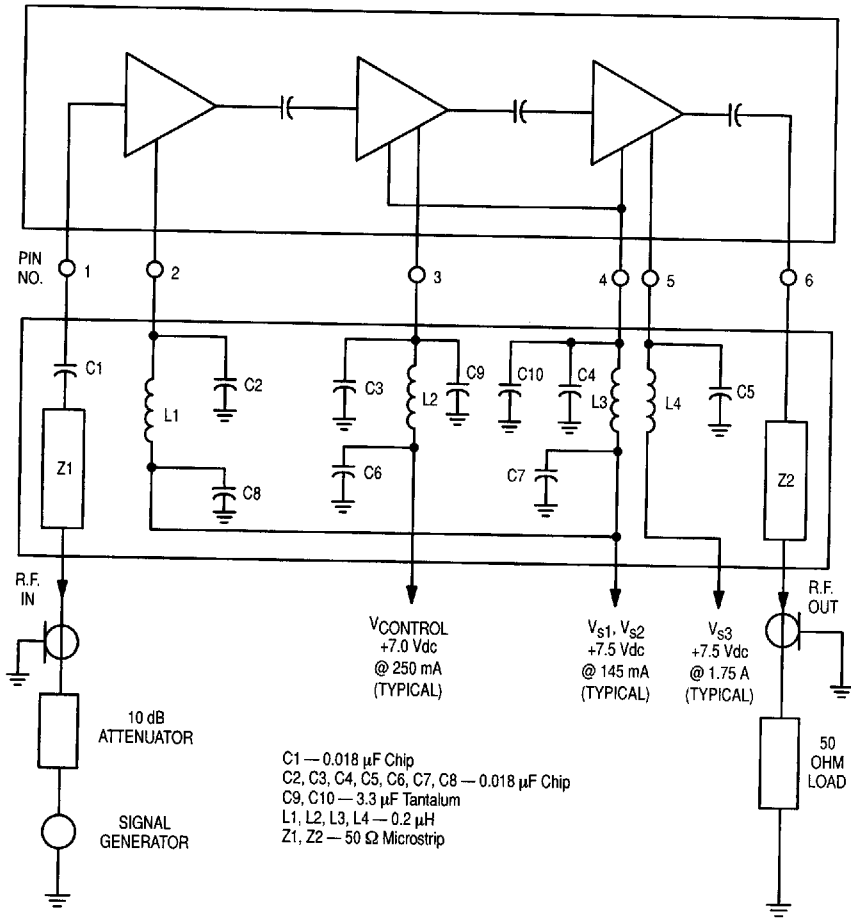

Figure 1. Power Module Test System Block Diagram

TYPICAL CHARACTERISTICS

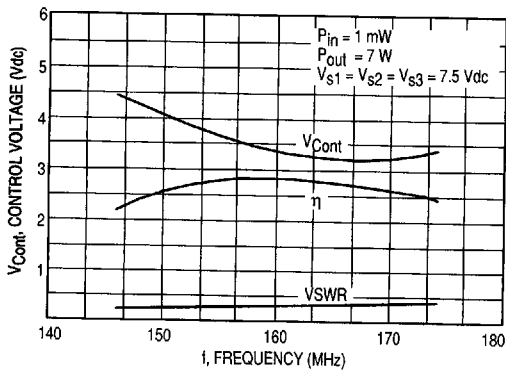

Figure 2. Control Voltage, Efficiency and VSWR versus Frequency

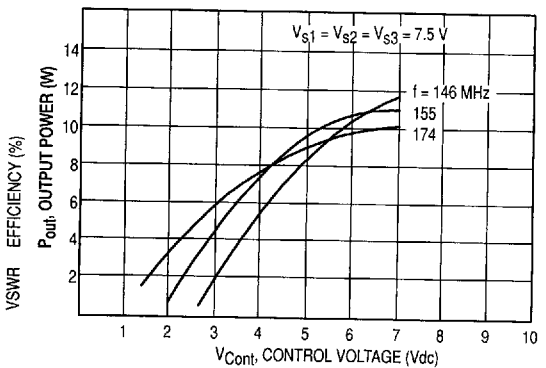

Figure 3. Output Power versus Control Voltage

TYPICAL CHARACTERISTICS

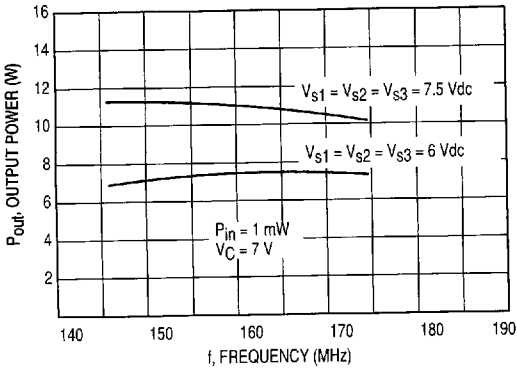

Figure 4. Output Power versus Frequency

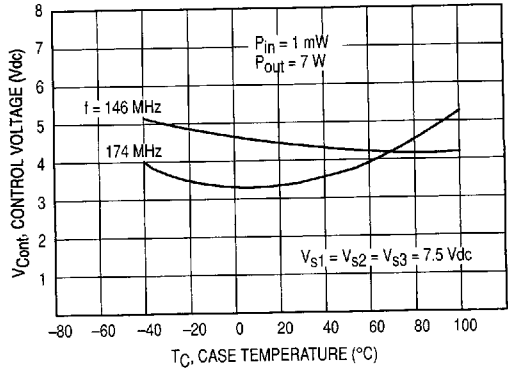

Figure 5. Control Voltage versus Case Temperature

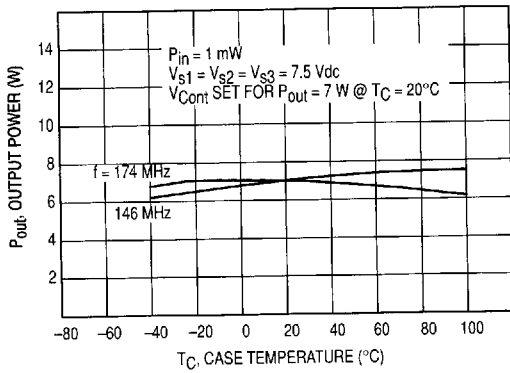

Figure 6. Output Power versus Case Temperature

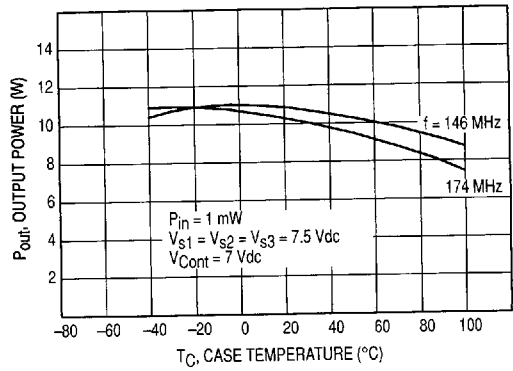

Figure 7. Output Power versus Case Temperature at Maximum Control Voltage

APPLICATIONS INFORMATION

NOMINAL OPERATION

All electrical specifications are based on the nominal conditions of $V_{S1} = V_{S2} = V_{S3} = 7.5$ Vdc (Pins 2, 4, 5) and P_{out} equal to 7.0 watts. With these conditions, maximum current density on any device is 1.5×10^5 A/cm² and maximum die temperature with 100°C case operating temperature is 165°C. While the modules are designed to have excess gain margin with ruggedness, operation of these units outside the limits of published specifications is not recommended unless prior communications regarding intended use have been made with the factory representative.

GAIN CONTROL

The module output should be limited to 7.0 watts. The preferred method of power output control is to fix $V_{S1} = V_{S2} = V_{S3} = 7.5$ Vdc (Pins 2, 4, 5), P_{in} (Pin 1) at 1.0 mW, and vary V_{Cont} (Pin 3) voltage.

DECOUPLING

Due to the high gain of the three stages and the module size limitation, external decoupling networks require careful consideration. Pins 2, 3, 4 and 5 are internally bypassed with a 0.018 μ F chip capacitor which is effective for frequencies from 5.0 MHz through 174 MHz. For bypassing frequencies below 5.0 MHz, networks equivalent to that shown in Figure 1 are recommended. Inadequate decoupling will result in spurious outputs at certain operating frequencies and certain phase angles of input and output VSWR.

LOAD MISMATCH

During final test, each module is load mismatch tested in a fixture having the identical decoupling networks described in Figure 1. Electrical conditions are $V_{S1} = V_{S2} = V_{S3}$ equal to 9.0 Vdc, VSWR equal to 20:1, and output power equal to 8.0 watts.