

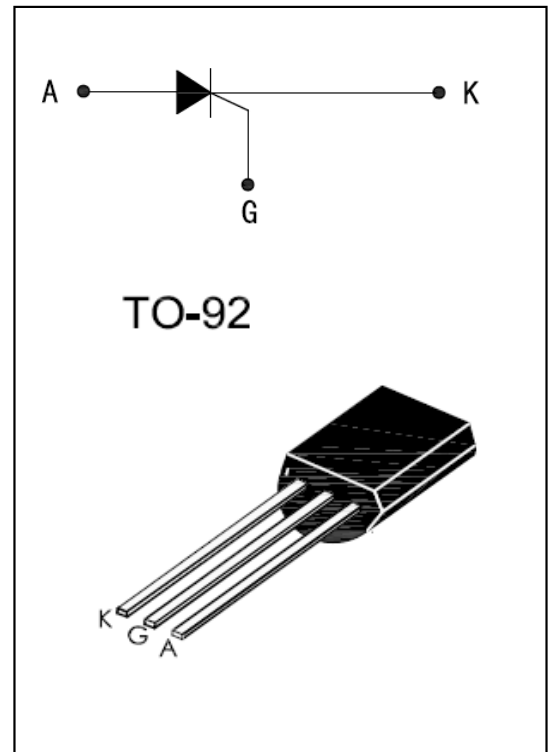

High sensitive triggering levels, the IPS4008 series SCRs is suitable for all applications, where the available gate current is limited, such as capacitive discharge ignitions, motor control in kitchen aids, overvoltage crowbar protection in low power supplies...

MAIN FEATURES

| Symbol | Value | Unit |
|---------------------|------------|---------|
| $I_{T(AV)}$ | 0.8 | A |
| V_{DRM} / V_{RRM} | 400 | V |
| I_{GT} | ≤ 200 | μA |



ABSOLUTE MAXIMUM RATINGS

| Parameter | Symbol | Value | Unit |
|---|--------------|-------------|-------------|
| Storage Junction Temperature Range | T_{stg} | -40 to +150 | $^{\circ}C$ |
| Operating Junction Temperature Range | T_j | -40 to +125 | $^{\circ}C$ |
| Repetitive Peak Off-state Voltage | V_{DRM} | 400 | V |
| Repetitive Peak Reverse Voltage | V_{RRM} | 400 | V |
| RMS on-state current (180 conduction angle) $T_c = 77^{\circ}C$ | $I_{T(RMS)}$ | 0.8 | A |
| Average on-state current (180 conduction angle) $T_c = 77^{\circ}C$ | $I_{T(AV)}$ | 0.5 | A |
| Non repetitive surge peak on-state Current ($T_j = 25^{\circ}C$) $t_p = 10\text{ms}$ $t_p = 8.3\text{ms}$ | I_{TSM} | 9 10 | A |
| I^2t Value for fusing $t_p = 10\text{ms}$ | I^2t | 0.415 | A^2s |
| Peak gate current $t_p = 20\mu s, T_j = 110^{\circ}C$ | I_{GM} | 0.2 | A |
| Average gate power dissipation $T_j = 110^{\circ}C$ | $P_{G(AV)}$ | 0.1 | W |

ELECTRICAL CHARACTERISTICS (T_j = 25 °C unless otherwise specified)

| Symbol | Test Condition | | IPS4008-xxU | | | | Unit |
|------------------|--|-----|-------------|----|----|----|------|
| | | | 03 | 05 | 06 | 08 | |
| I _{GT} | V _D = 6V R _L = 100Ω | MIN | 10 | 20 | 30 | 50 | uA |
| | | MAX | 30 | 50 | 60 | 80 | |
| V _{GT} | | TYP | 0.6 | | | | V |
| | | MAX | 0.8 | | | | |
| V _{GD} | V _D =V _D RM, R _L =3.3KΩ, R _{GK} = 1KΩ T _j = 110 °C | MIN | 0.2 | | | | V |
| I _L | I _G = 1mA R _{GK} = 1KΩ | MAX | 6 | | | | mA |
| I _H | I _T = 50mA R _{GK} = 1KΩ | MAX | 5 | | | | mA |
| V _{TM} | I _T = 1A t _p = 380uS T _j = 25 °C | TYP | 1.3 | | | | V/us |
| | | MAX | 1.7 | | | | |
| dV/dt | V _D = 67% V _D RM R _{GK} = 1KΩ T _j = 110 °C | MIN | 10 | | | | V/us |
| I _{DRM} | V _D = V _D RM R _{GK} = 1KΩ T _j = 25 °C | MAX | 5 | | | | uA |
| | V _D = V _D RM R _{GK} = 1KΩ T _j = 110 °C | MAX | 0.1 | | | | mA |
| I _{RRM} | V _R = V _R RM R _{GK} = 1KΩ T _j = 25 °C | MAX | 5 | | | | uA |
| | V _D = V _R RM R _{GK} = 1KΩ T _j = 110 °C | MAX | 0.1 | | | | mA |

Please ask the I_{GT} values to our sales if you want to get another values.

THERMAL RESISTANCES

| Symbol | Parameter | | Value | Unit |
|-------------------------|------------------|-------|-------|------|
| R _{th} (j - c) | Junction to case | TO-92 | 75 | °C/W |

PACKAGE MECHANICAL DATA

TO-92

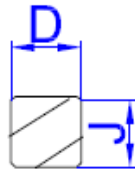
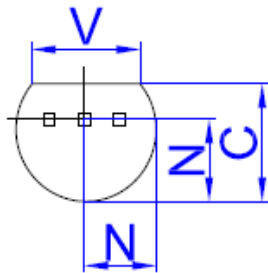

SECTION X-X

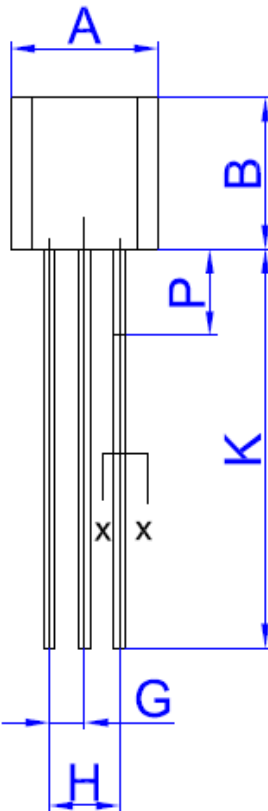

| Ref | Dimensions | | | |
|-----|-------------|-------|--------|-------|
| | Millimeters | | Inches | |
| | Min | Max | Min | Max |
| A | 4.45 | 5.2 | 0.175 | 0.205 |
| B | 4.32 | 5.33 | 0.170 | 0.210 |
| C | 3.18 | 4.19 | 0.125 | 0.165 |
| D | 0.407 | 0.533 | 0.016 | 0.021 |
| G | 1.15 | 1.39 | 0.045 | 0.055 |
| H | 2.42 | 2.66 | 0.095 | 0.105 |
| J | 0.39 | 0.50 | 0.015 | 0.020 |
| K | 12.70 | - | 0.500 | - |
| N | 2.04 | 2.66 | 0.080 | 0.105 |
| P | - | 2.54 | - | 0.100 |
| V | 3.43 | - | 0.135 | - |

FIG.1: Maximum power dissipation versus RMS on-state current(full cycle)

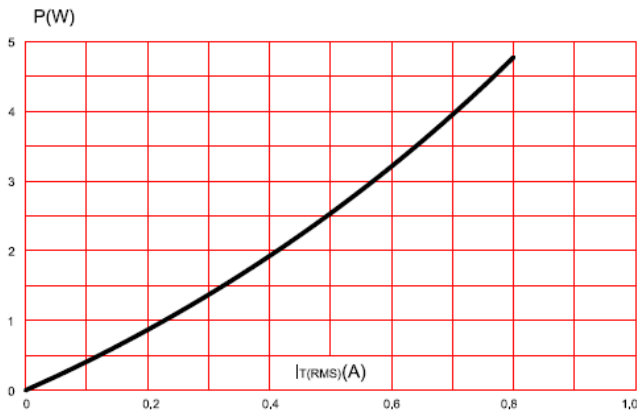

FIG.2: RMS on-state current versus case temperature(full cycle)

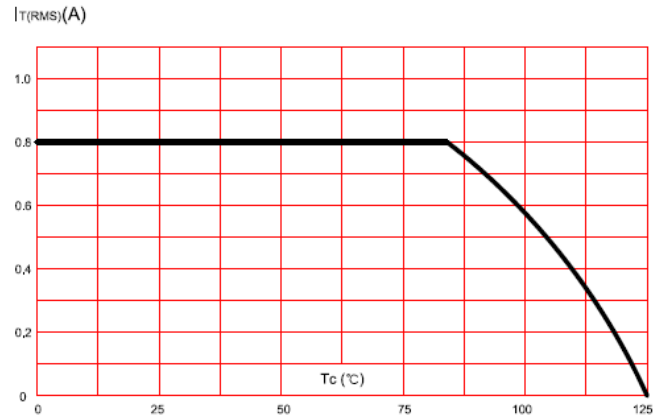

FIG.3: On-state characteristics (maximum values)

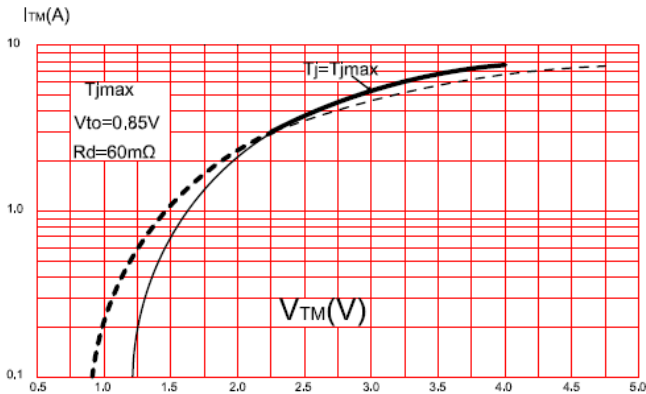

FIG.4: Surge peak on-state current versus number of cycles.

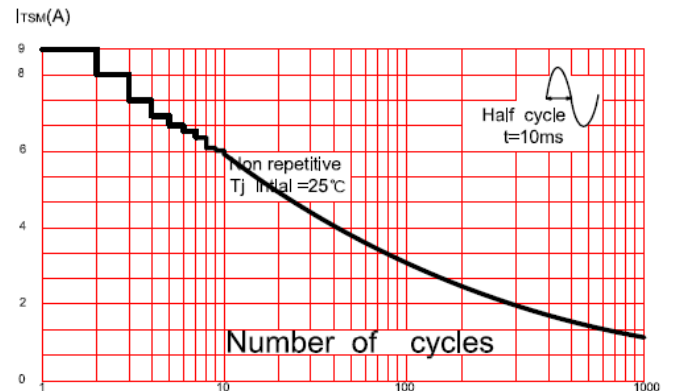

FIG.5: Non-repetitive surge peak on-state current for a sinusoidal pulse with width $t_p < 10\text{ms}$.

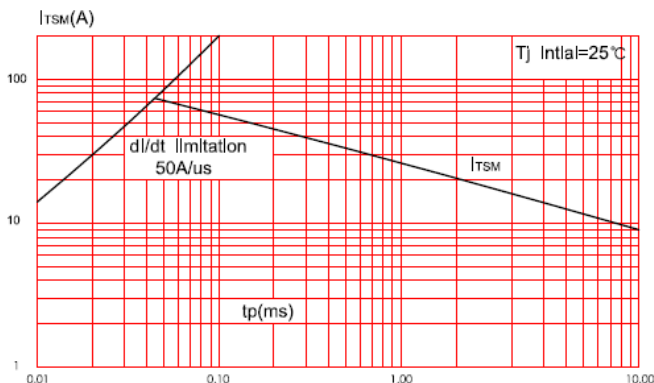

FIG.6: Relative variation of gate trigger current, holding current and latching current versus junction temperature(typical values).

