

DATA SHEET

PTS34/19/I
PT, PTS, PTS/I cores and
accessories

Supersedes data of September 2004

2008 Sep 01

CORE SETS

Effective core parameters

SYMBOL	PARAMETER	VALUE	UNIT
$\Sigma(l/A)$	core factor (C1)	0.339	mm ⁻¹
V_e	effective volume	8140	mm ³
l_e	effective length	52.5	mm
A_e	effective area	155	mm ²
A_{min}	minimum area	145	mm ²
m	mass of set	≈ 46	g

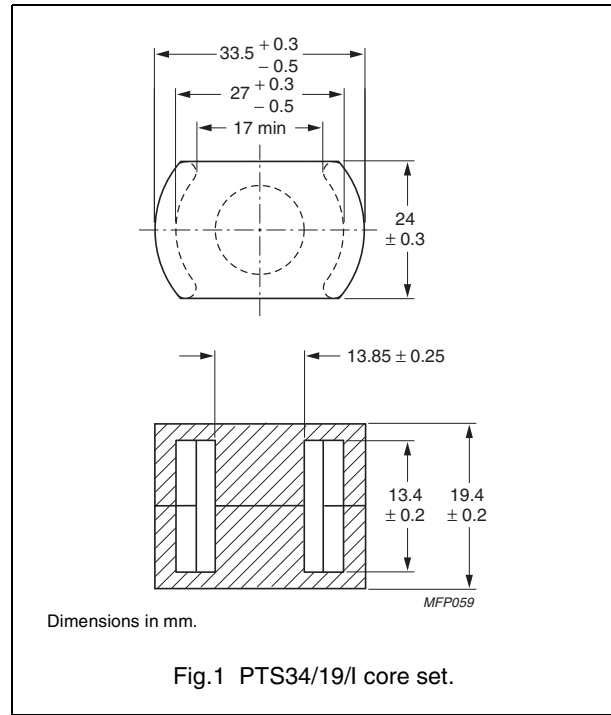

Core sets for general purpose transformers and power applications

Clamping force for A_L measurements, 80 ± 20 N.

GRADE	A_L (nH)	μ_e	AIR GAP (μm)	TYPE NUMBER
3C92 <small>des</small>	4770 ± 25 %	≈ 1290	≈ 0	PTS34/19/I-3C92
3C94	6800 ± 25 %	≈ 1830	≈ 0	PTS34/19/I-3C94
3C96 <small>des</small>	6070 ± 25 %	≈ 1640	≈ 0	PTS34/19/I-3C96

Properties of core sets under power conditions

GRADE	B (mT) at	CORE LOSS (W) at		
	H = 250 A/m; f = 25 kHz; T = 100 °C	f = 100 kHz; B = 100 mT; T = 100 °C	f = 100 kHz; B = 200 mT; T = 100 °C	f = 500 kHz; B = 50 mT; T = 100 °C
3C92	≥320	≤ 0.8	≤ 4.9	–
3C94	≥320	≤ 0.8	≤ 4.9	–
3C96	≥315	≤ 0.6	≤ 3.7	≤ 3.0



DATA SHEET STATUS DEFINITIONS

DATA SHEET STATUS	PRODUCT STATUS	DEFINITIONS
Preliminary specification	Development	This data sheet contains preliminary data. Ferroxcube reserves the right to make changes at any time without notice in order to improve design and supply the best possible product.
Product specification	Production	This data sheet contains final specifications. Ferroxcube reserves the right to make changes at any time without notice in order to improve design and supply the best possible product.

DISCLAIMER

Life support applications — These products are not designed for use in life support appliances, devices, or systems where malfunction of these products can reasonably be expected to result in personal injury. Ferroxcube customers using or selling these products for use in such applications do so at their own risk and agree to fully indemnify Ferroxcube for any damages resulting from such application.

PRODUCT STATUS DEFINITIONS

STATUS	INDICATION	DEFINITION
Prototype		These are products that have been made as development samples for the purposes of technical evaluation only. The data for these types is provisional and is subject to change.
Design-in		These products are recommended for new designs.
Preferred		These products are recommended for use in current designs and are available via our sales channels.
Support		These products are not recommended for new designs and may not be available through all of our sales channels. Customers are advised to check for availability.