

# SPGP0365A/SPGN0365A

VER : Preliminary\_2  
( SEMIHOW POWER SWITCH )

## FEATURES

- Variable frequency operation
- Low Start-up Current(Typ.100uA )
- Pulse by Pulse Current Limiting
- Over Current Protection
- Over Voltage Protection (Min. 20)
- Internal Thermal Shutdown Function
- Under Voltage Lockout
- Internal High Voltage Sense FET
- Auto-Restart Mode
- Frequency Modulation for low EMI
- Advanced Burst-Mode Operation

## APPLICATION

- SMPS for STB, SVR, DVD & DVCD
- SMPS for Printer, Facsimile & Scanner
- Adaptor

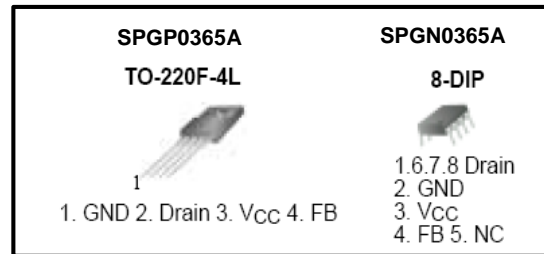

## DESCRIPTION

The SemiHow Power Switch product family is specially designed for an off-line SMPS with minimal external components.

The SemiHow Power Switch consists of a high voltage power SenseFET and a current mode PWM IC.

It has a basic platform well suited for the cost effective design in either a flyback converter

## INTERNAL BLOCK DIAGRAM

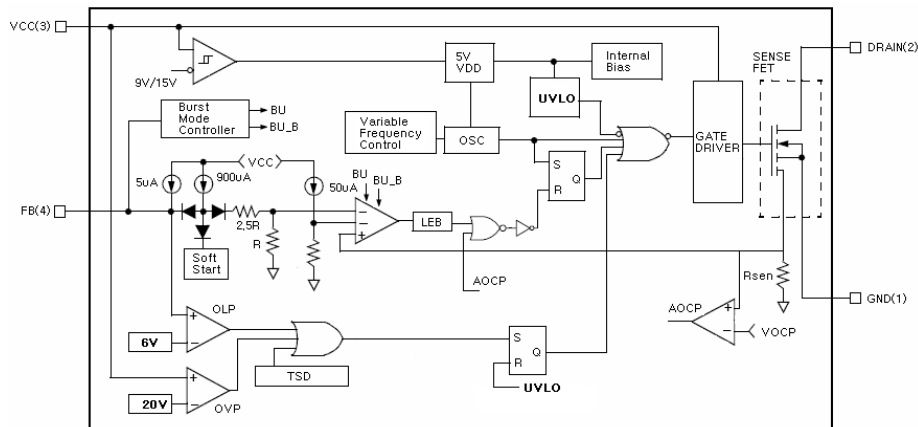

## Absolute Maximum Ratings

Ta=25°C, unless otherwise specified

### SPGP0365A

Symbol	Parameter	Value	Units
V <sub>DSS</sub>	Drain-Source Voltage	650	V
I <sub>D</sub>	Drain Current – Continuous (T <sub>C</sub> = 25 °C)	3.0	A
	Drain Current – Continuous (T <sub>C</sub> = 100 °C)	2.4	A
I <sub>DM</sub>	Drain Current – Pulsed (Note 1)	12	A
V <sub>GS</sub>	Gate-Source Voltage	±30	V
E <sub>AS</sub>	Single Pulsed Avalanche Energy (Note 2)	248	mJ
V <sub>CC(MAX)</sub>	Maximum Supply voltage	20	V
V <sub>FB</sub>	Analog Input Voltage Range	-0.3 To V <sub>SD</sub>	V
P <sub>D</sub>	Power Dissipation (T <sub>C</sub> = 25 °C)	75	W
	- Derate above 25 °C	0.6	W/°C
T <sub>J</sub>	Operating Junction Temperature	+160	°C
T <sub>A</sub>	Operating Ambient Temperature	-25 to +85	°C
T <sub>STG</sub>	Storage Temperature Range	-55 to +150	°C

### SPGN0365A

Symbol	Parameter	Value	Units
V <sub>DSS</sub>	Drain-Source Voltage	650	V
I <sub>D</sub>	Drain Current – Continuous (T <sub>C</sub> = 25 °C)	0.42	A
	Drain Current – Continuous (T <sub>C</sub> = 100 °C)	0.28	A
I <sub>DM</sub>	Drain Current – Pulsed (Note 1)	3	A
V <sub>GS</sub>	Gate-Source Voltage	±30	V
E <sub>AS</sub>	Single Pulsed Avalanche Energy (Note 2)	127	mJ
V <sub>CC(MAX)</sub>	Maximum Supply voltage	20	V
V <sub>FB</sub>	Analog Input Voltage Range	-0.3 To V <sub>SD</sub>	V
P <sub>D</sub>	Power Dissipation (T <sub>C</sub> = 25 °C)	1.56	W
	- Derate above 25 °C	0.0125	W/°C
T <sub>J</sub>	Operating Junction Temperature	+160	°C
T <sub>A</sub>	Operating Ambient Temperature	-25 to +85	°C
T <sub>STG</sub>	Storage Temperature Range	-55 to +150	°C

#### Notes :

1. Repetitive Rating : Pulse width limited by maximum junction temperature
2. L=51mH, I<sub>AS</sub>=3.0A, V<sub>DD</sub>=50V, R<sub>G</sub>=25Ω, Starting T<sub>J</sub>=25°C

## Electrical Characteristics ( SenseFET Part )

Ta=25°C, unless otherwise specified

Symbol	Parameter	Test Conditions	Min	Typ	Max	Units
<b>On Characteristics</b>						
R <sub>DS(ON)</sub>	Static Drain-Source On-Resistance	V <sub>GS</sub> = 10 V, I <sub>D</sub> = 1.5 A	--	3.0	3.75	Ω
<b>Off Characteristics</b>						
BV <sub>DSS</sub>	Drain-Source Breakdown Voltage	V <sub>GS</sub> = 0 V, I <sub>D</sub> = 50 μA	650	--	--	V
I <sub>DSS</sub>	Zero Gate Voltage Drain Current	V <sub>DS</sub> = 650 V, V <sub>GS</sub> = 0 V	--	--	50	μA
		V <sub>DS</sub> = 520 V, T <sub>C</sub> = 125°C	--	--	200	μA
<b>Dynamic Characteristics</b>						
C <sub>iss</sub>	Input Capacitance	V <sub>DS</sub> = 25 V, V <sub>GS</sub> = 0 V, f = 1.0 MHz	--	450	580	pF
C <sub>oss</sub>	Output Capacitance		--	55	72	pF
C <sub>rss</sub>	Reverse Transfer Capacitance		--	12	15.5	pF
<b>Switching Characteristics</b>						
t <sub>d(on)</sub>	Turn-On Time	V <sub>DS</sub> = 325 V, I <sub>D</sub> = 3.0 A, R <sub>G</sub> = 25 Ω  (Note 4,5)	--	18	--	ns
T <sub>r</sub>	Turn-On Rise Time		--	15	--	ns
t <sub>d(off)</sub>	Turn-Off Delay Time		--	80	--	ns
t <sub>f</sub>	Turn-Off Fall Time		--	30	--	ns
Q <sub>g</sub>	Total Gate Charge	V <sub>DS</sub> = 325V, I <sub>D</sub> = 3.0 A, V <sub>GS</sub> = 10 V  (Note 4,5)	--	13	17	nC
Q <sub>gs</sub>	Gate-Source Charge		--	2.5	--	nC
Q <sub>gd</sub>	Gate-Drain Charge		--	5.5	--	nC

### Notes :

1. Pulse Test : Pulse Width ≤ 300μs, Duty Cycle ≤ 2%

$$2. S = \frac{1}{R}$$

## Electrical Characteristics ( Control Part )

Ta=25°C, unless otherwise specified

Symbol	Parameter	Test Conditions	Min	Typ	Max	Units
<b>UVLO Section</b>						
V <sub>START</sub>	Start Threshold Voltage	V <sub>FB</sub> = GND	14	15	16	V
V <sub>STOP</sub>	Stop Threshold Voltage	V <sub>FB</sub> = GND	8.4	9	9.6	V
<b>Oscillator Section</b>						
F <sub>OSC</sub>	Initial Accuracy		57	64	71	KHz
--	Frequency Change With Temperature (Note 2)	-25°C ≤ Ta ≤ +85°C	--	±5	±10	%
D <sub>MAX</sub>	Maximum Duty Cycle		73	77	82	%
<b>FEEDBACK Section</b>						
I <sub>FB</sub>	Feedback Source Current	Ta=25°C, 0V<Vfb<3V	0.7	0.9	1.1	mA
V <sub>SD</sub>	Shutdown Feedback Voltage	Vfb>6.5V	5.4	6	6.6	V
I <sub>delay</sub>	Shutdown Delay Current	Ta=25°C, 5VδVfbδVSD	4	5	6	mA
<b>Reference Section</b>						
V <sub>REF</sub>	Reference Output Voltage (Note 1)	Ta=25°C	4.8	5	5.2	V
V <sub>ref</sub> /ΔT	Temperature Stability (Note 1 , 2)	-25°C ≤ Ta ≤ +85°C	--	0.3	0.6	mV/°C
I <sub>OVER</sub>	Peak Current Limit	Max. inductor current	1.62	2.0	2.38	A
<b>Protection Section</b>						
V <sub>OVP</sub>	Over Voltage Protection	VCC > 20V	20	--	23	V
T <sub>SD</sub>	Thermal Shutdown Temperature (Tj) (Note 1)	--	140	160	--	°C
<b>Protection Section</b>						
I <sub>START</sub>	Start-up Current	VCC = 14V	--	100	170	μA
I <sub>OP</sub>	Operating Supply Current (Control Part Only)	VCC < 20V	--	3	6	mA

### Notes :

1. These parameters, although guaranteed, are not 100% tested in production
2. These parameters, although guaranteed, are tested in EDS(water test) process

## Typical Characteristics ( SenseFET Part ) (SPGP0365A)

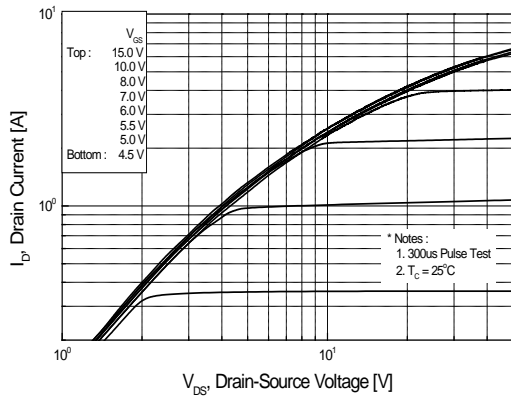

Figure 1. On Region Characteristics

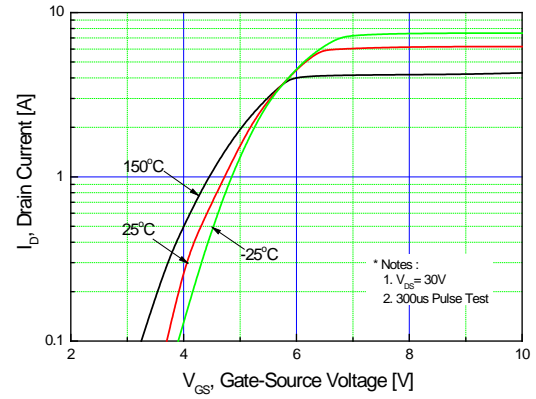

Figure 2. Transfer Characteristics

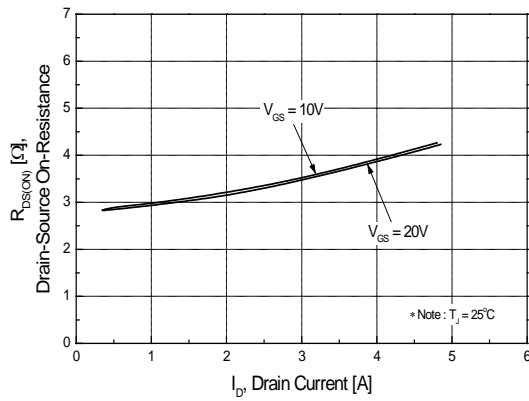

Figure 3. On Resistance Variation vs Drain Current and Gate Voltage

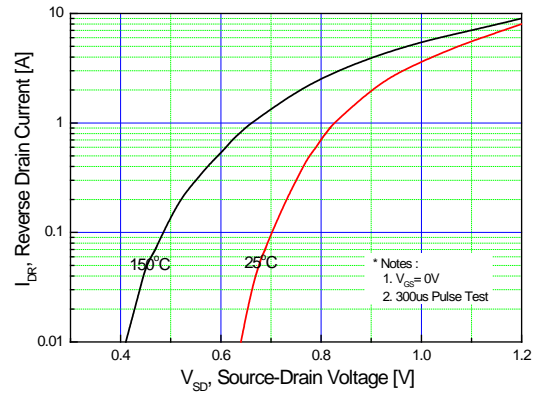

Figure 4. Body Diode Forward Voltage Variation with Source Current and Temperature

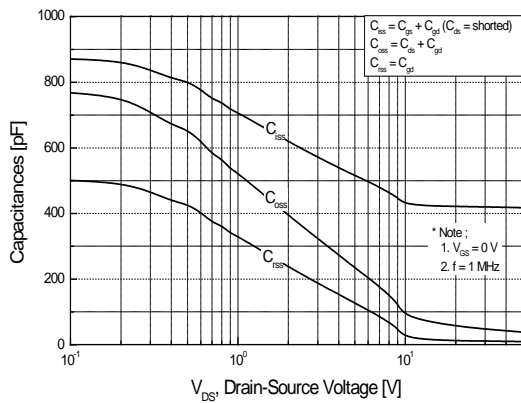

Figure 5. Capacitance Characteristics

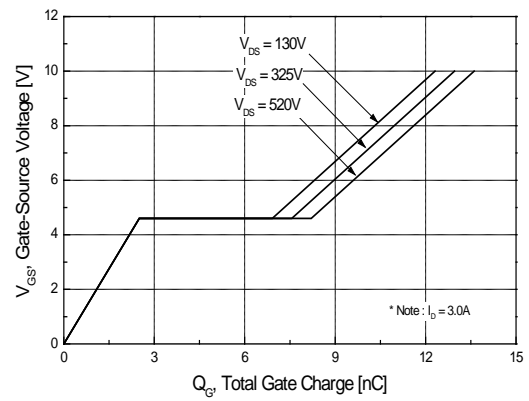
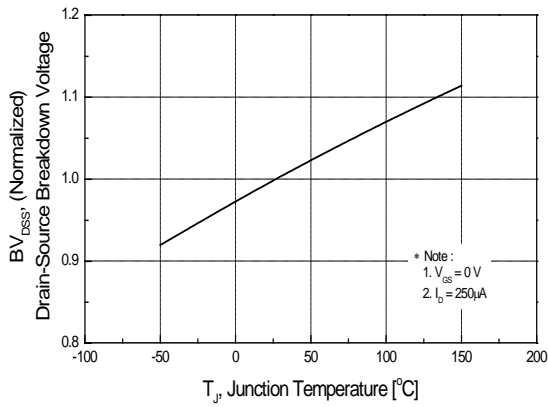
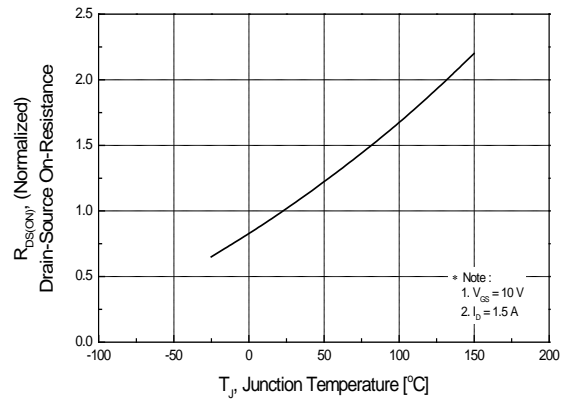

Figure 6. Gate Charge Characteristics

**Typical Characteristics ( SenseFET Part ) (continued)**  
(SPGP0365A)



**Figure 7. Breakdown Voltage Variation vs Temperature**



**Figure 8. On-Resistance Variation vs Temperature**

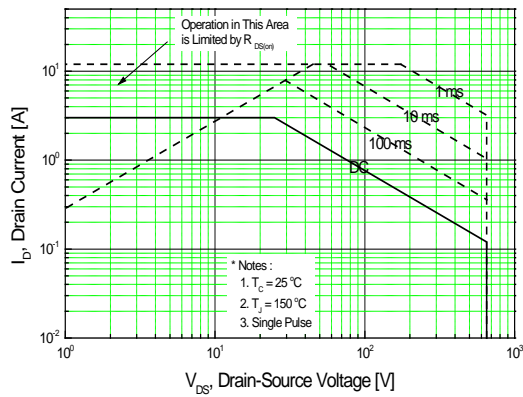

**Figure 9. Maximum Safe Operating Area**

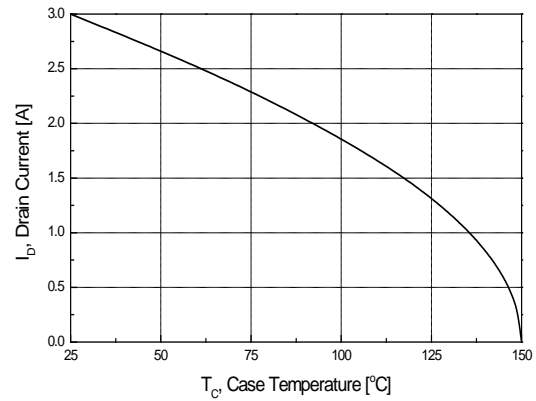

**Figure 10. Maximum Drain Current vs Case Temperature**

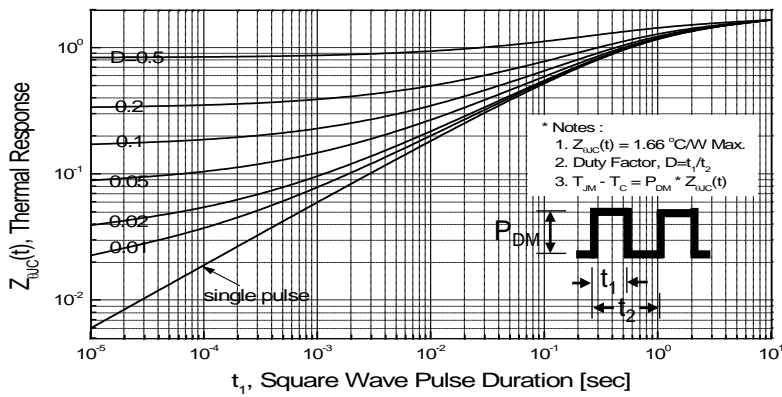

**Figure 11. Transient Thermal Response Curve**

## Typical Characteristics ( SenseFET Part ) (SPGN0365A)

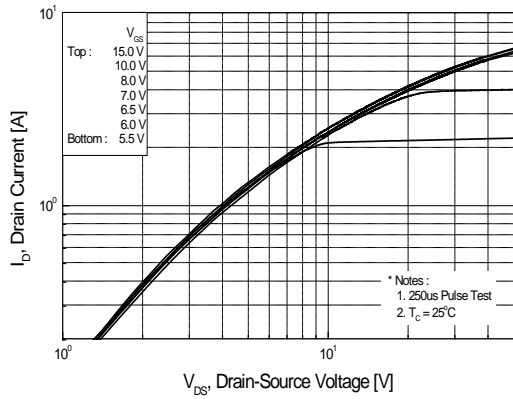

Figure 1. On Region Characteristics

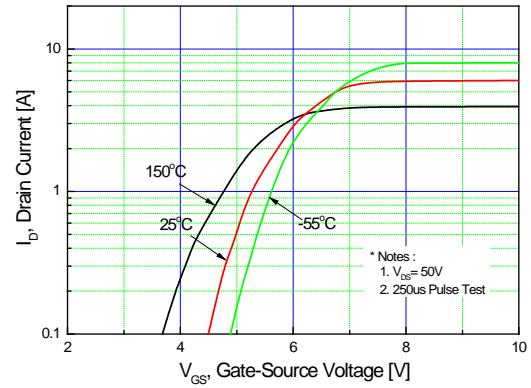

Figure 2. Transfer Characteristics

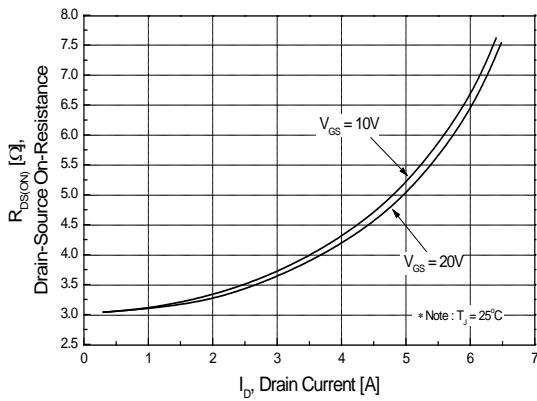

Figure 3. On Resistance Variation vs Drain Current and Gate Voltage

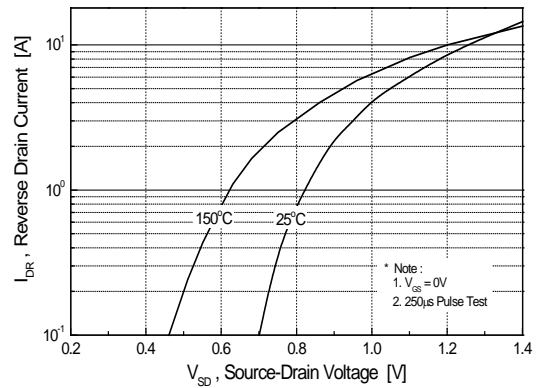

Figure 4. Body Diode Forward Voltage Variation with Source Current and Temperature

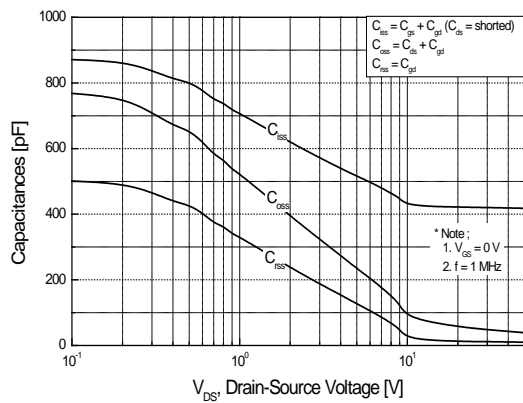

Figure 5. Capacitance Characteristics

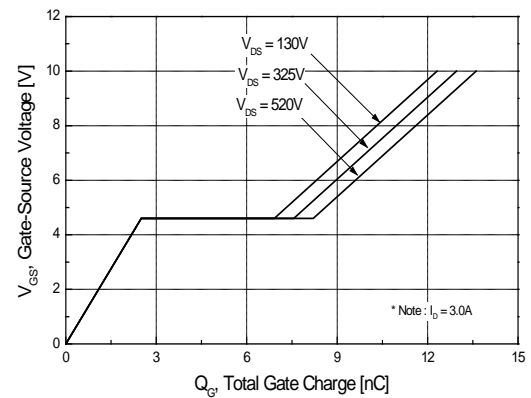
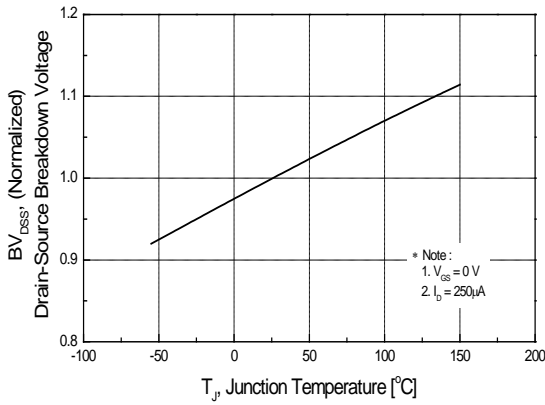
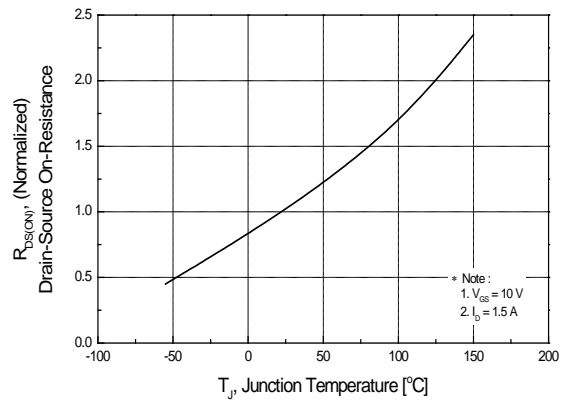

Figure 6. Gate Charge Characteristics

**Typical Characteristics ( SenseFET Part ) (continued)**  
(SPGN0365A)



**Figure 7. Breakdown Voltage Variation vs Temperature**



**Figure 8. On-Resistance Variation vs Temperature**

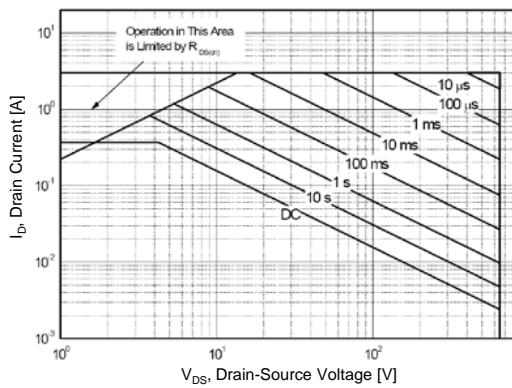

**Figure 9. Maximum Safe Operating Area**

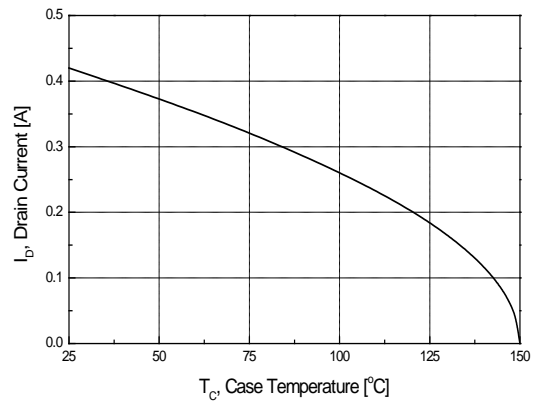

**Figure 10. Maximum Drain Current vs Case Temperature**

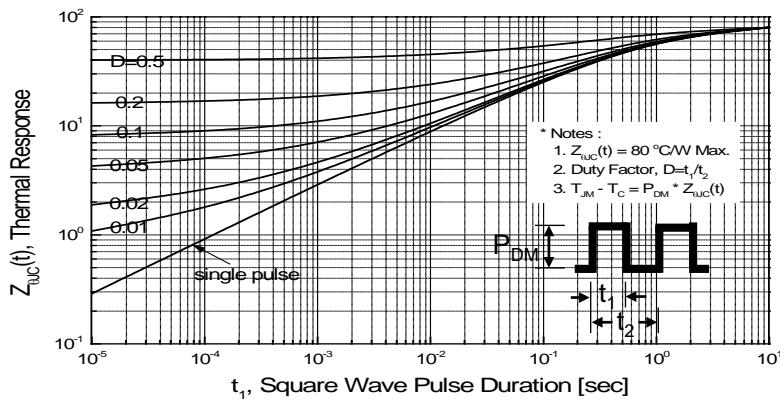
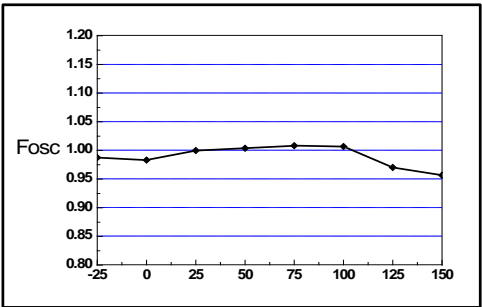

**Figure 11. Transient Thermal Response Curve**



**Typical Performance Characteristics ( Control Part ) (continued)**

(These characteristic graphs are normalized at Ta=25°C)



**Figure 1. Operating Frequency**

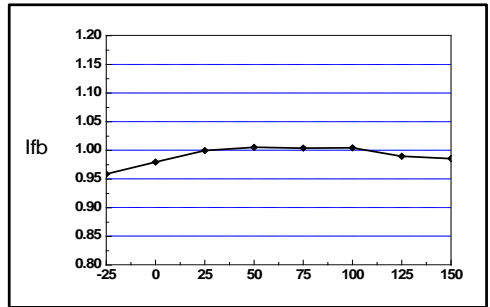

**Figure 2. Feedback Source Current**

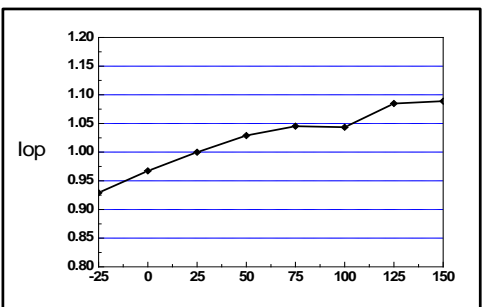

**Figure 3. Operating Supply Current**

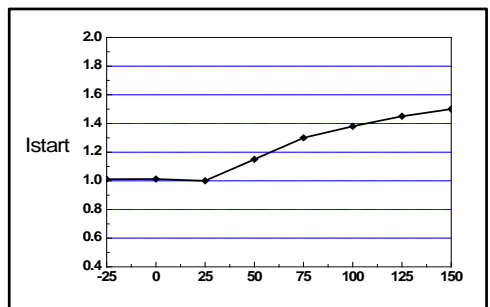

**Figure 4. Start up Current**

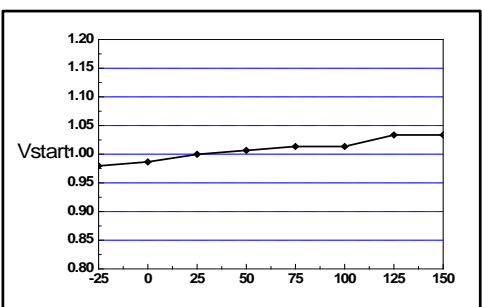

**Figure 5. Start Threshold Voltage**

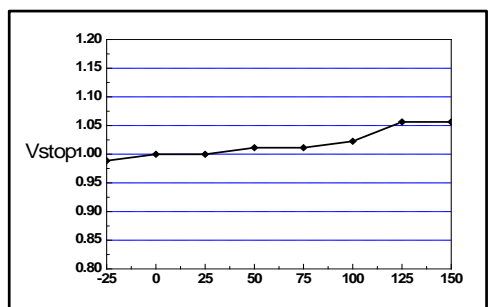

**Figure 6. Stop Threshold Voltage**

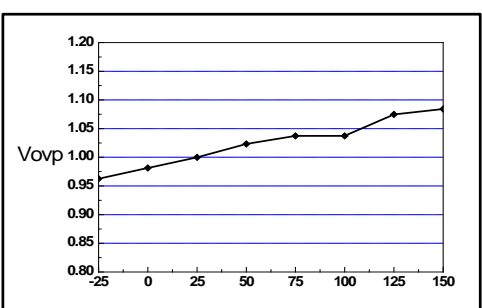

**Figure 7. Over Voltage Protection**

Package Dimension

TO-220F-4L

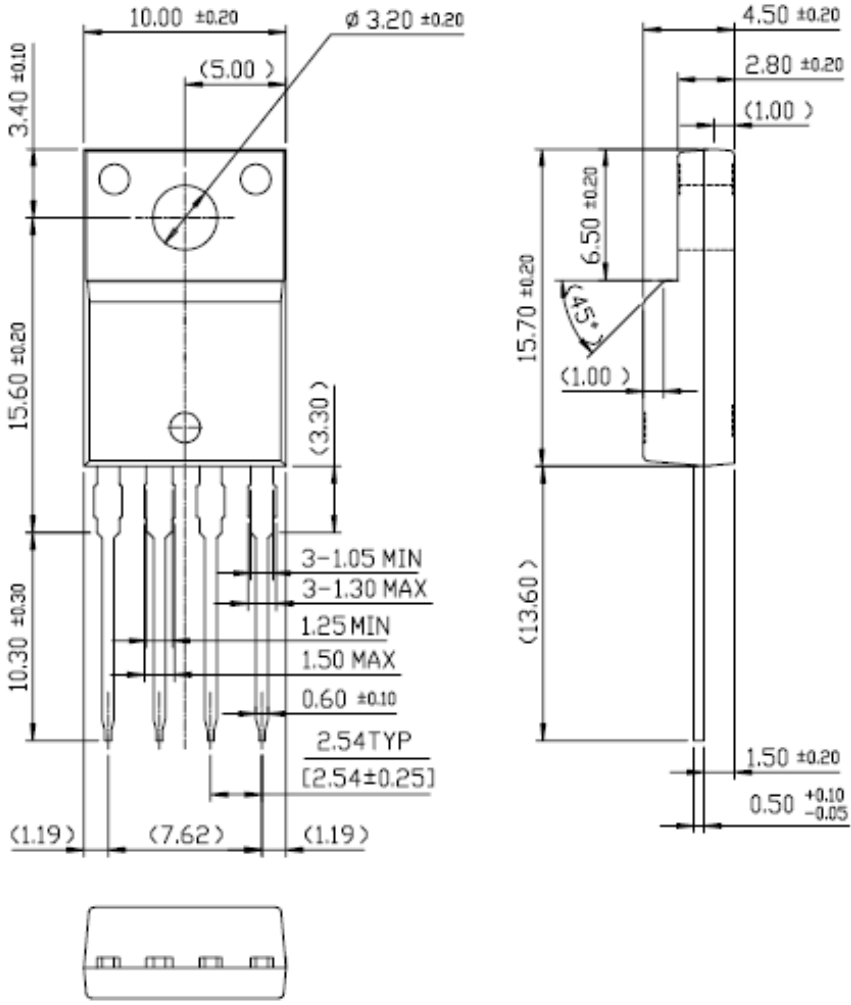

SPGN0365A/SPGP0365A-Preliminary

8-DIP

