



CX9VSM CRYSTAL

32 kHz to 160 kHz

Ultra-Miniature, Low Profile
Surface Mount Quartz Crystal

DESCRIPTION

Designed and manufactured in the USA, the CX9V quartz crystal is available in frequencies from 32 kHz to 160 kHz. Using micro-machining processes, this surface-mountable crystal is hermetically sealed within a ultra-miniature ceramic package to ensure high stability and low aging. Tight calibration and high frequency/temperature stability make the CX9V ideally suited for all low frequency applications.

FEATURES

- Ultra-miniature, surface mount design (4.1 mm x 1.5mm)
- Low profile (typically 0.80mm)
- Available with glass or ceramic lid
- Hermetically sealed ceramic package
- High shock and vibration survival
- Excellent aging characteristics
- Designed for low power applications
- Full military testing available
- Designed and manufactured in the USA

APPLICATIONS

Medical

- Pacemaker, defibrillator, and other implantables
- Medical instruments

Industrial, Computer, & Communications

- Smart card
- Down hole instrumentation
- Transponder / Animal migration
- Process instrumentation

Military & Aerospace

- Airborne hybrid
- Navigational computer
- Real time clock

EQUIVALENT CIRCUIT

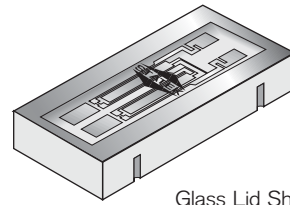
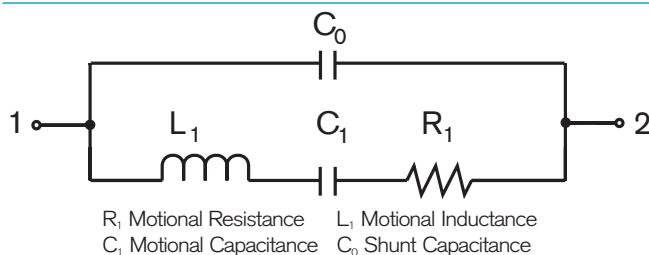

Glass Lid Shown

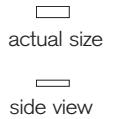

PACKAGE DIMENSIONS

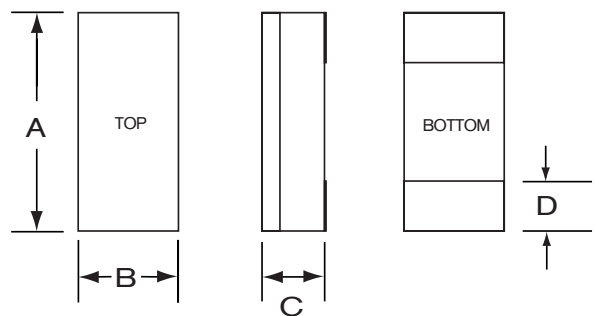

DIM	TYP.		MAX.	
	inches	mm	inches	mm
A	0.160	4.10	0.170	4.32
B	0.060	1.50	0.068	1.73
C	-	-	see below	
D	0.031	0.79	0.038	0.97
DIM "C"	GLASS LID		CERAMIC LID	
MAX	inches	mm	inches	mm
SM1	0.035	0.89	0.038	0.97
SM2	0.036	0.91	0.039	0.99
SM3	0.037	0.94	0.040	1.02

SUGGESTED LAND PATTERN

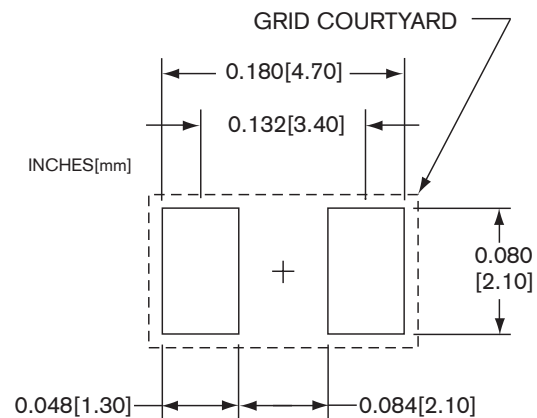

10157 - Rev A



SPECIFICATIONS

Specifications are typical at 25°C unless otherwise noted.
Specifications are subject to change without notice.

	32.768 kHz	100 kHz
Motional Resistance R_1 (k Ω)	70	19
Motional Capacitance C_1 (fF)	2.2	1.0
Quality Factor Q (k)	27	80
Shunt Capacitance C_0 (pF)	1.1	0.84
Load Capacitance (pF)*	9	5
Turning Point (°C)**	20	16

Standard Calibration Tolerance***

Glass Lid: ± 30 ppm, ± 100 ppm, ± 1000 ppm
Ceramic Lid: ± 100 ppm, ± 1000 ppm, ± 10000 ppm

Drive Level	0.5 μ W MAX
Temperature Coefficient (k)	-0.035 ppm/°C ²
Aging, first year	5 ppm
Shock, survival	5,000 G peak, 0.3 ms, 1/2 sine
Vibration, survival	20 G RMS, 10-2,000 Hz random
Operating Temp. Range	-10°C to +70°C (Commercial) -40°C to +85°C (Industrial) -55°C to +125°C (Military)
Storage Temp. Range	-55°C to +125°C
Max Process Temperature	260°C for 20 sec.

Note: Deviation in frequency (f) @ temperature (T) from frequency (f_0) @ turning point temperature (T_0);

$$\frac{f-f_0}{f_0} = k(T-T_0)^2$$

* Other load capacitance values available

** Other temperatures available

*** Tighter tolerances available

TERMINATIONS

Designation	Termination
SM1	Gold Plated
SM2	Nickel, Solder Plated
SM3	Nickel, Solder Dipped

PACKAGING OPTIONS

CX9VSM	-Tray Pack
	-16mm tape, 7" or 13" reels
	Per EIA 481 (see data sheet 10109)

CONVENTIONAL CMOS PIERCE OSCILLATOR CIRCUIT

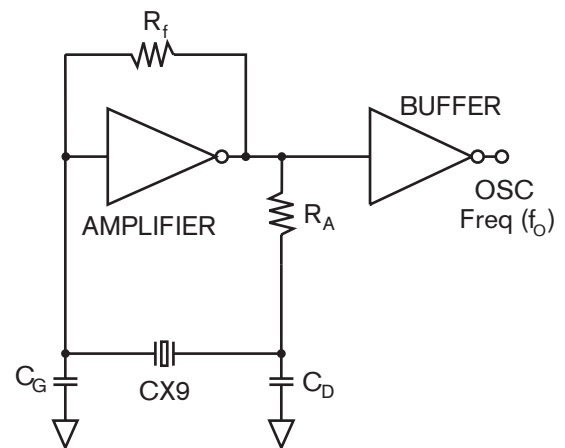

HOW TO ORDER CX9VSM CRYSTALS

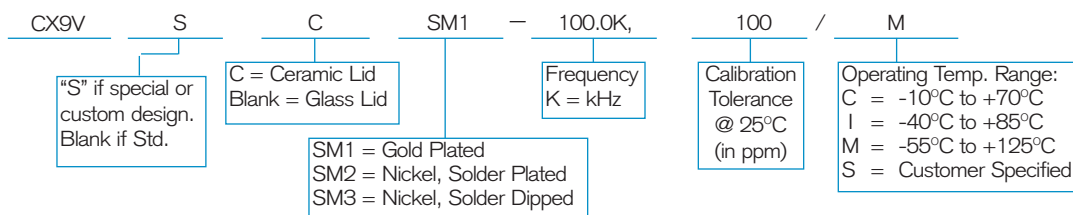

10157 - Rev A