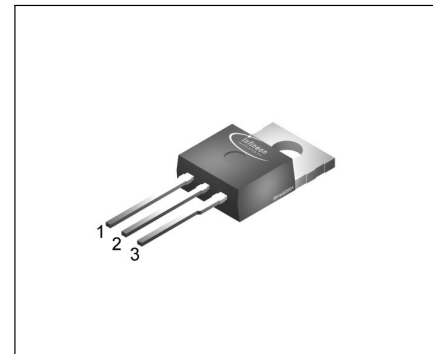

**SIPMOS<sup>®</sup> Power Transistor**

- N channel
- Enhancement mode
- Avalanche-rated
- Pb-free lead plating; RoHS compliant

**BUZ 73A H**

Pin 1	Pin 2	Pin 3
G	D	S

Type	V <sub>DS</sub>	I <sub>D</sub>	R <sub>DS(on)</sub>	Package	Pb-free
BUZ 73 A	200 V	5.5 A	0.6 Ω	PG-TO-220-3	yes

**Maximum Ratings**

Parameter	Symbol	Values	Unit
Continuous drain current <i>T<sub>C</sub></i> = 37 °C	I <sub>D</sub>	5.5	A
Pulsed drain current <i>T<sub>C</sub></i> = 25 °C	I <sub>Dpuls</sub>	22	
Avalanche current, limited by <i>T<sub>jmax</sub></i>	I <sub>AR</sub>	7	
Avalanche energy, periodic limited by <i>T<sub>jmax</sub></i>	E <sub>AR</sub>	6.5	mJ
Avalanche energy, single pulse I <sub>D</sub> = 7 A, V <sub>DD</sub> = 50 V, R <sub>GS</sub> = 25 Ω L = 3.67 mH, <i>T<sub>j</sub></i> = 25 °C	E <sub>AS</sub>	120	
Gate source voltage	V <sub>GS</sub>	± 20	V
Power dissipation <i>T<sub>C</sub></i> = 25 °C	P <sub>tot</sub>	40	W
Operating temperature	<i>T<sub>j</sub></i>	-55 ... + 150	°C
Storage temperature	<i>T<sub>stg</sub></i>	-55 ... + 150	
Thermal resistance, chip case	R <sub>thJC</sub>	≤ 3.1	K/W
Thermal resistance, chip to ambient	R <sub>thJA</sub>	75	
DIN humidity category, DIN 40 040		E	
IEC climatic category, DIN IEC 68-1		55 / 150 / 56	

**Electrical Characteristics**, at  $T_j = 25^\circ\text{C}$ , unless otherwise specified

Parameter	Symbol	Values			Unit
		min.	typ.	max.	
<b>Static Characteristics</b>					
Drain- source breakdown voltage $V_{GS} = 0\text{ V}$ , $I_D = 0.25\text{ mA}$ , $T_j = 25^\circ\text{C}$	$V_{(BR)DSS}$	200	-	-	V
Gate threshold voltage $V_{GS} = V_{DS}$ , $I_D = 1\text{ mA}$	$V_{GS(th)}$	2.1	3	4	
Zero gate voltage drain current $V_{DS} = 200\text{ V}$ , $V_{GS} = 0\text{ V}$ , $T_j = 25^\circ\text{C}$ $V_{DS} = 200\text{ V}$ , $V_{GS} = 0\text{ V}$ , $T_j = 125^\circ\text{C}$	$I_{DSS}$	-	0.1 10	1 100	$\mu\text{A}$
Gate-source leakage current $V_{GS} = 20\text{ V}$ , $V_{DS} = 0\text{ V}$	$I_{GSS}$	-	10	100	nA
Drain-Source on-resistance $V_{GS} = 10\text{ V}$ , $I_D = 4.5\text{ A}$	$R_{DS(on)}$	-	0.5	0.6	$\Omega$

**Electrical Characteristics**, at  $T_j = 25^\circ\text{C}$ , unless otherwise specified

Parameter	Symbol	Values			Unit
		min.	typ.	max.	
<b>Dynamic Characteristics</b>					
Transconductance $V_{DS} \geq 2 \cdot I_D \cdot R_{DS(on)max}$ , $I_D = 4.5\text{ A}$	$g_{fs}$	3	4.2	-	S
Input capacitance $V_{GS} = 0\text{ V}$ , $V_{DS} = 25\text{ V}$ , $f = 1\text{ MHz}$	$C_{iss}$	-	400	530	pF
Output capacitance $V_{GS} = 0\text{ V}$ , $V_{DS} = 25\text{ V}$ , $f = 1\text{ MHz}$	$C_{oss}$	-	85	130	
Reverse transfer capacitance $V_{GS} = 0\text{ V}$ , $V_{DS} = 25\text{ V}$ , $f = 1\text{ MHz}$	$C_{rss}$	-	45	70	
Turn-on delay time $V_{DD} = 30\text{ V}$ , $V_{GS} = 10\text{ V}$ , $I_D = 3\text{ A}$ $R_{GS} = 50\ \Omega$	$t_{d(on)}$	-	10	15	ns
Rise time $V_{DD} = 30\text{ V}$ , $V_{GS} = 10\text{ V}$ , $I_D = 3\text{ A}$ $R_{GS} = 50\ \Omega$	$t_r$	-	40	60	
Turn-off delay time $V_{DD} = 30\text{ V}$ , $V_{GS} = 10\text{ V}$ , $I_D = 3\text{ A}$ $R_{GS} = 50\ \Omega$	$t_{d(off)}$	-	55	75	
Fall time $V_{DD} = 30\text{ V}$ , $V_{GS} = 10\text{ V}$ , $I_D = 3\text{ A}$ $R_{GS} = 50\ \Omega$	$t_f$	-	30	40	

**Electrical Characteristics, at  $T_j = 25^\circ\text{C}$ , unless otherwise specified**

Parameter	Symbol	Values			Unit
		min.	typ.	max.	
<b>Reverse Diode</b>					
Inverse diode continuous forward current $T_C = 25^\circ\text{C}$	$I_S$	-	-	5.5	A
Inverse diode direct current, pulsed $T_C = 25^\circ\text{C}$	$I_{SM}$	-	-	22	
Inverse diode forward voltage $V_{GS} = 0\text{ V}, I_F = 14\text{ A}$	$V_{SD}$	-	1.3	1.7	V
Reverse recovery time $V_R = 100\text{ V}, I_F = I_S, di_F/dt = 100\text{ A}/\mu\text{s}$	$t_{rr}$	-	200	-	ns
Reverse recovery charge $V_R = 100\text{ V}, I_F = I_S, di_F/dt = 100\text{ A}/\mu\text{s}$	$Q_{rr}$	-	0.6	-	$\mu\text{C}$

**Power dissipation**

$$P_{\text{tot}} = f(T_C)$$

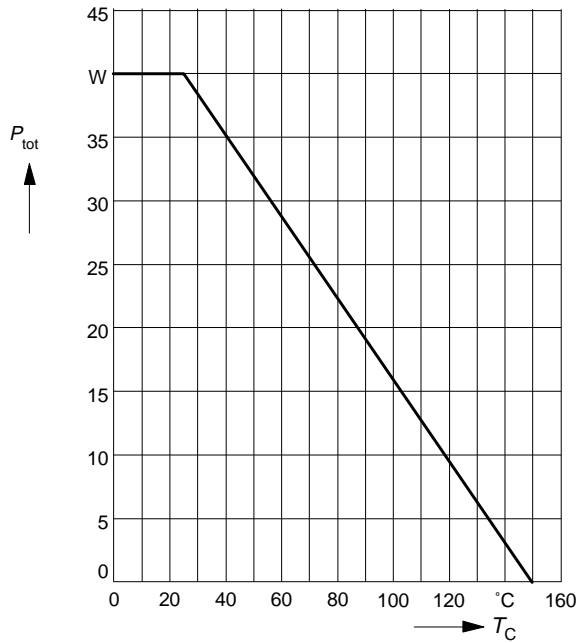

**Drain current**

$$I_D = f(T_C)$$

parameter:  $V_{GS} \geq 10 \text{ V}$

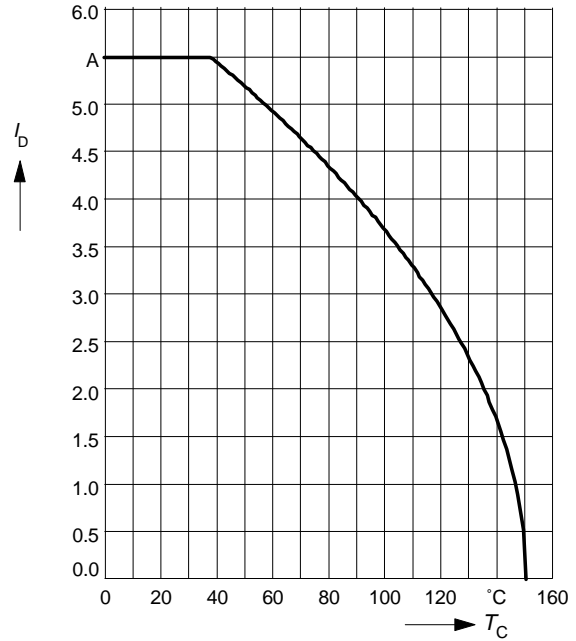

**Safe operating area**

$$I_D = f(V_{DS})$$

parameter:  $D = 0.01, T_C = 25^\circ\text{C}$

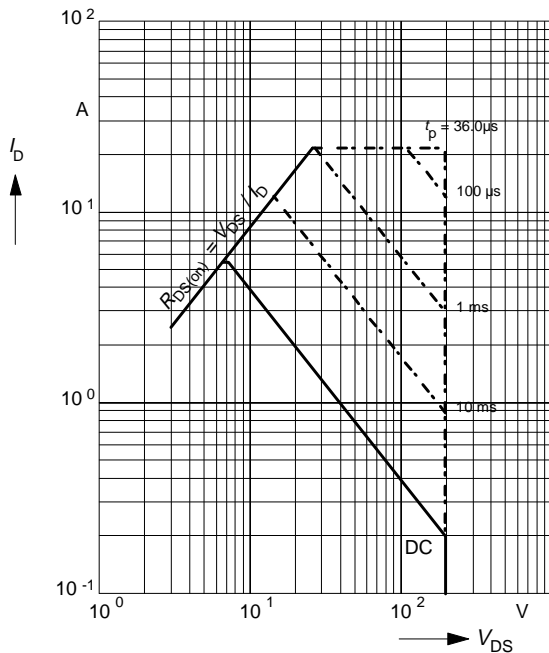

**Transient thermal impedance**

$$Z_{\text{thJC}} = f(t_p)$$

parameter:  $D = t_p / T$

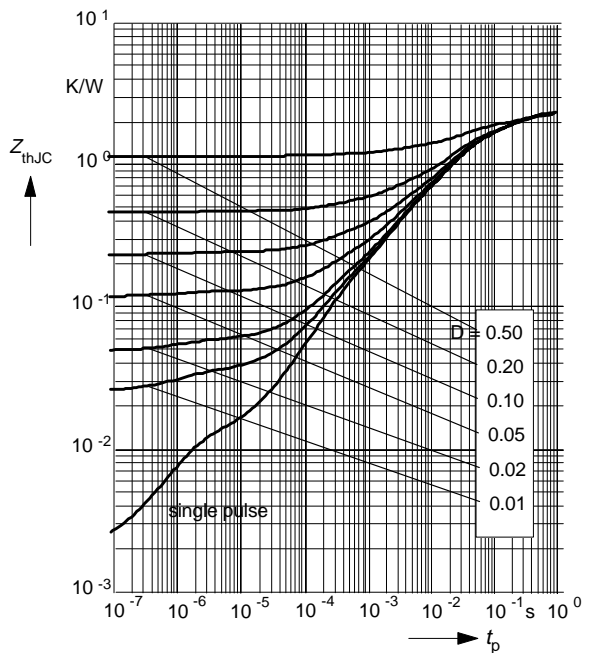

**Typ. output characteristics**

$I_D = f(V_{DS})$   
parameter:  $t_p = 80 \mu s$

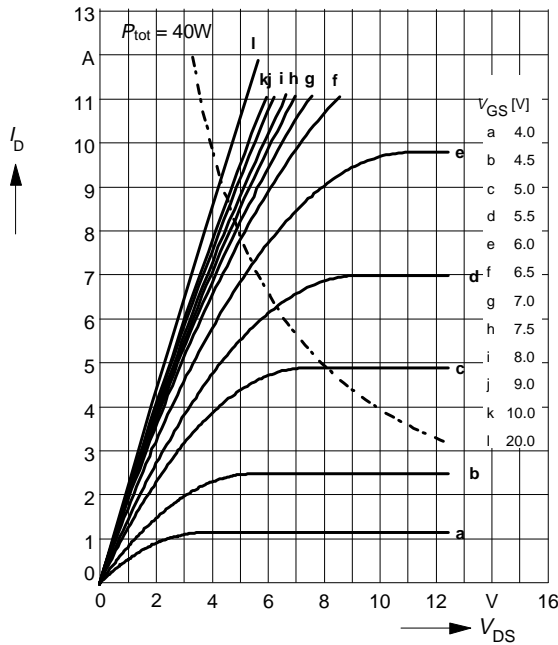

**Typ. drain-source on-resistance**

$R_{DS(on)} = f(I_D)$   
parameter:  $V_{GS}$

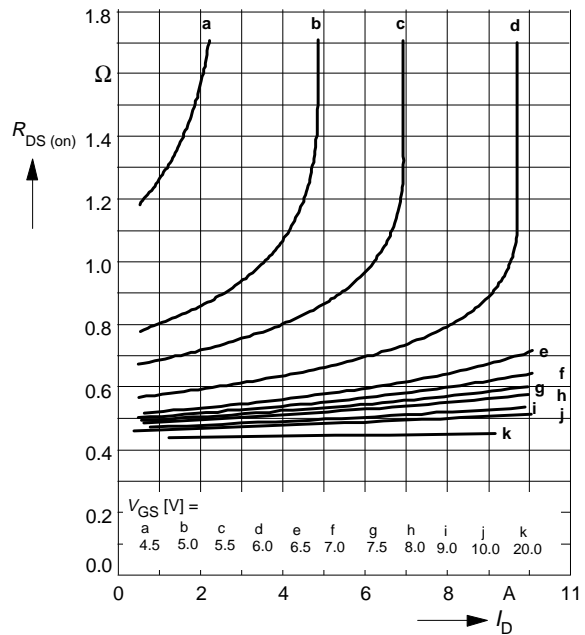

**Typ. transfer characteristics**  $I_D = f(V_{GS})$

parameter:  $t_p = 80 \mu s$   
 $V_{DS} \geq 2 \times I_D \times R_{DS(on)max}$

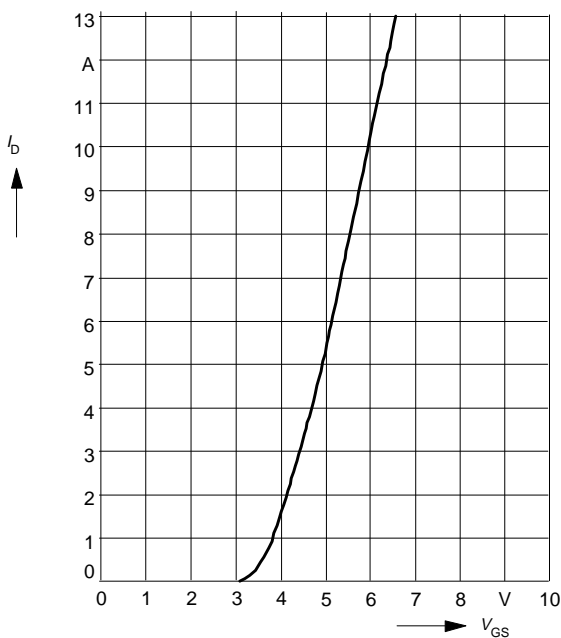

**Typ. forward transconductance**  $g_{fs} = f(I_D)$

parameter:  $t_p = 80 \mu s$ ,  
 $V_{DS} \geq 2 \times I_D \times R_{DS(on)max}$

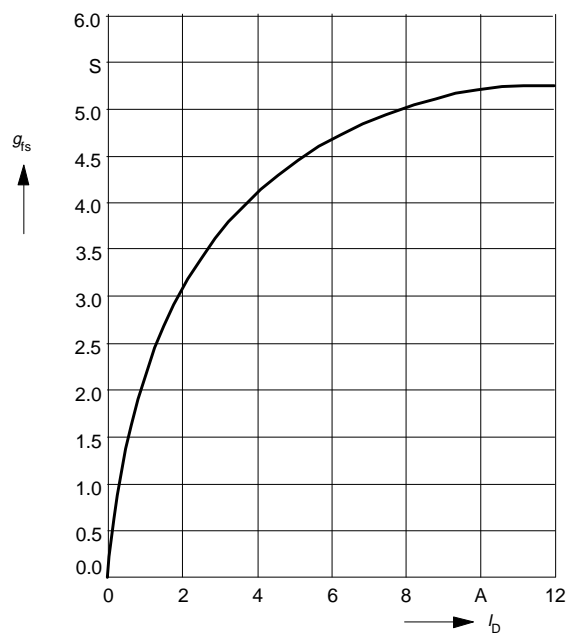

**Drain-source on-resistance**

$$R_{DS(on)} = f(T_j)$$

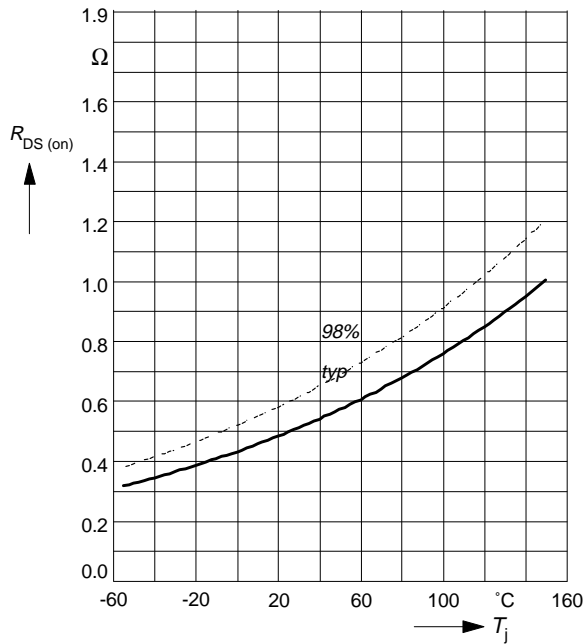
 parameter:  $I_D = 4.5 \text{ A}$ ,  $V_{GS} = 10 \text{ V}$ 

**Gate threshold voltage**

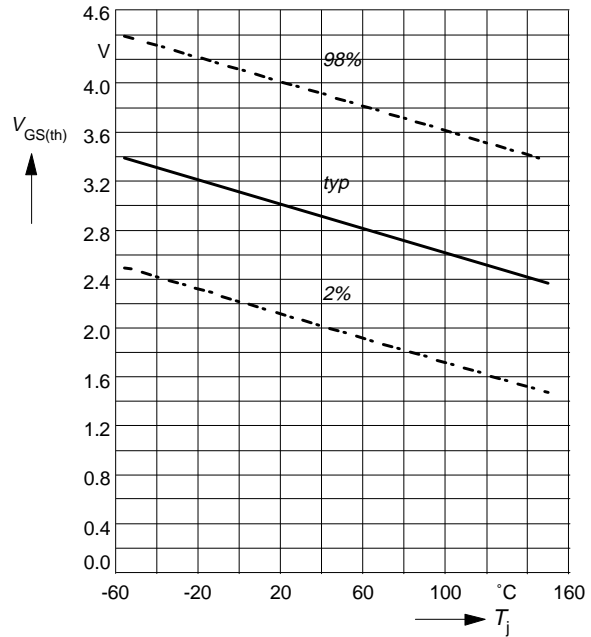
$$V_{GS(th)} = f(T_j)$$

 parameter:  $V_{GS} = V_{DS}$ ,  $I_D = 1 \text{ mA}$ 

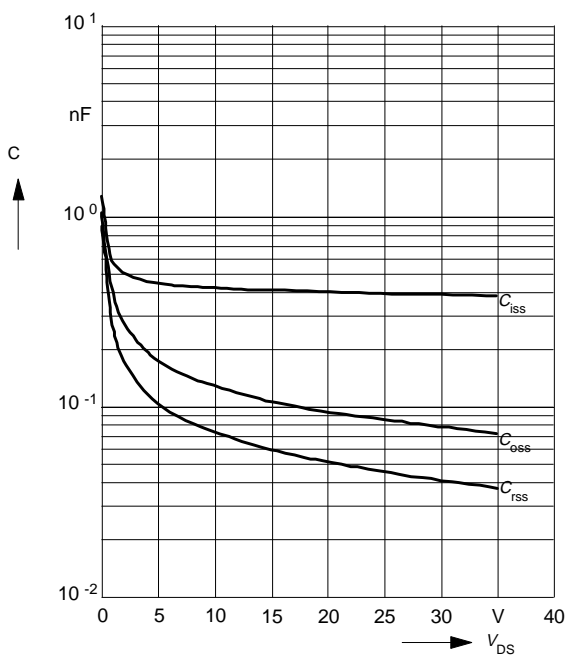
**Typ. capacitances**

$$C = f(V_{DS})$$

 parameter:  $V_{GS} = 0 \text{ V}$ ,  $f = 1 \text{ MHz}$ 

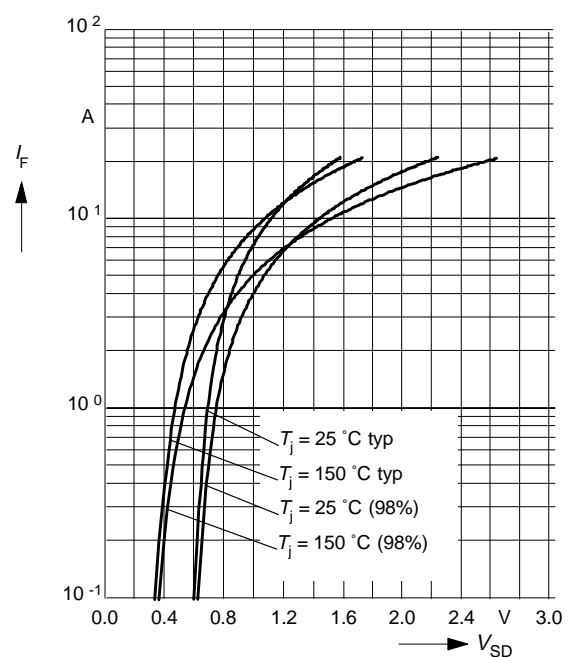
**Forward characteristics of reverse diode**

$$I_F = f(V_{SD})$$

 parameter:  $T_j$ ,  $t_p = 80 \mu\text{s}$ 

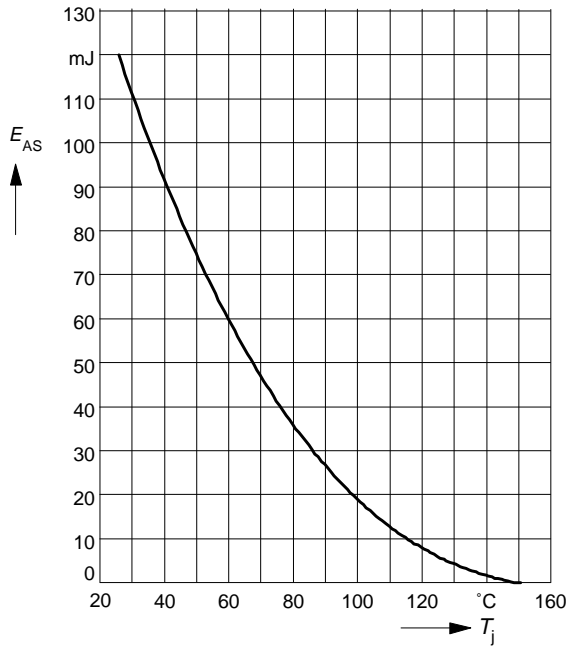
**Avalanche energy**  $E_{AS} = f(T_j)$   
 parameter:  $I_D = 7\text{ A}$ ,  $V_{DD} = 50\text{ V}$   
 $R_{GS} = 25\ \Omega$ ,  $L = 3.67\text{ mH}$



**Typ. gate charge**  
 $V_{GS} = f(Q_{Gate})$   
 parameter:  $I_{D\text{ puls}} = 14\text{ A}$

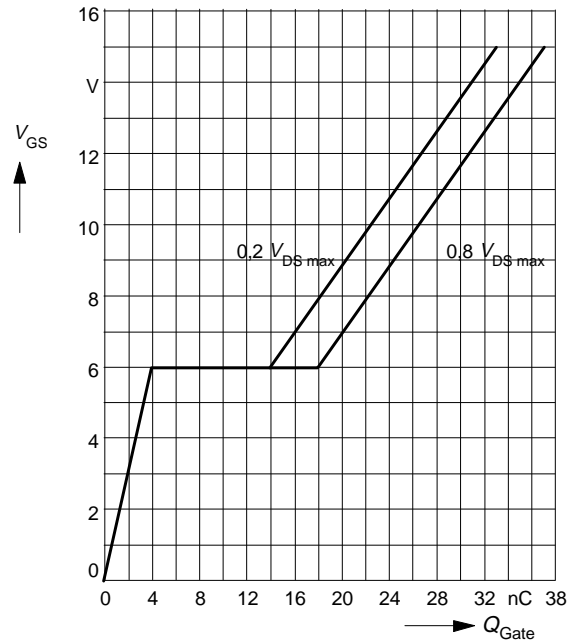

**Drain-source breakdown voltage**

$$V_{(BR)DSS} = f(T_j)$$

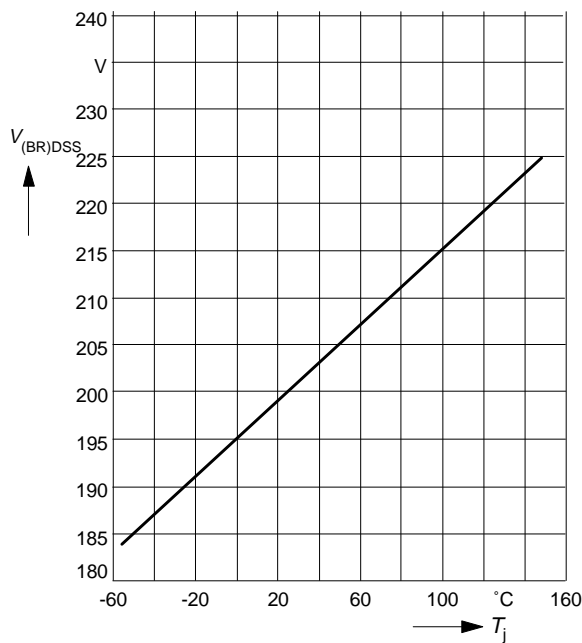



TO220-3

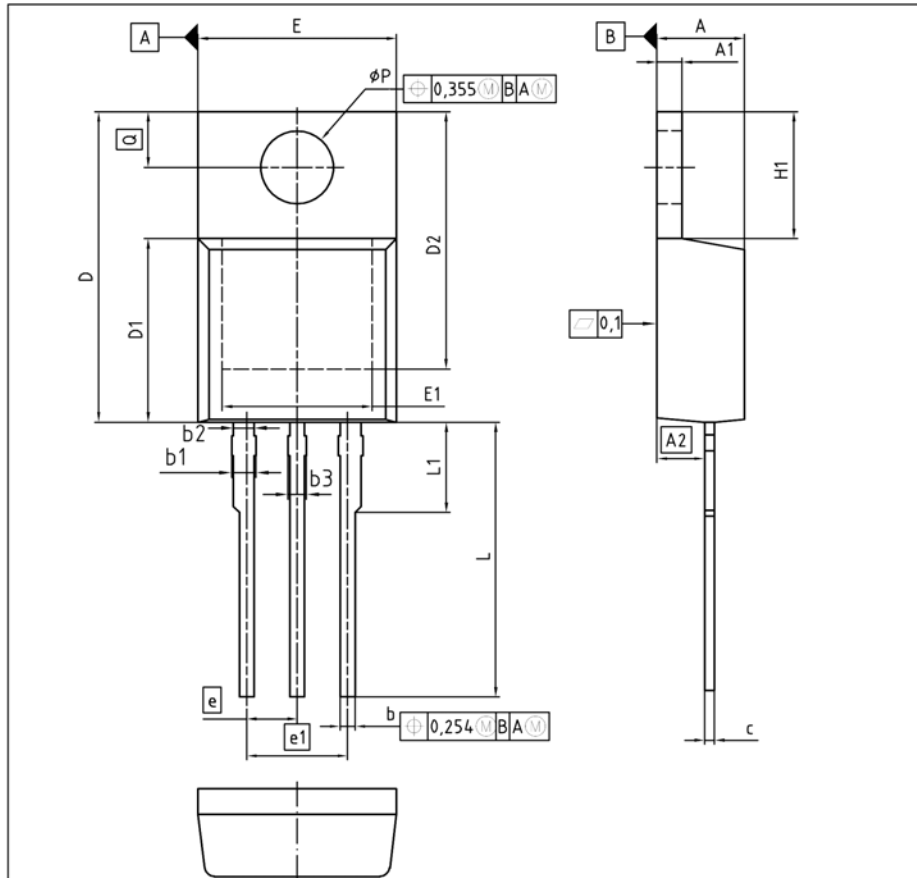

DIM	MILLIMETERS		INCHES	
	MIN	MAX	MIN	MAX
A	4.30	4.57	0.169	0.180
A1	1.17	1.40	0.046	0.055
A2	2.15	2.72	0.085	0.107
b	0.65	0.86	0.026	0.034
b1	0.95	1.40	0.037	0.055
b2	0.95	1.15	0.037	0.045
b3	0.65	1.15	0.026	0.045
c	0.33	0.60	0.013	0.024
D	14.81	15.95	0.583	0.628
D1	8.51	9.45	0.335	0.372
D2	12.19	13.10	0.480	0.516
E	9.70	10.36	0.382	0.408
E1	6.50	8.60	0.256	0.339
e	2.54		0.100	
e1	5.08		0.200	
N	3		3	
H1	5.90	6.90	0.232	0.272
L	13.00	14.00	0.512	0.551
L1	-	4.80	-	0.189
$\phi P$	3.60	3.89	0.142	0.153
Q	2.60	3.00	0.102	0.118

DOCUMENT NO.  
Z8B00003318

SCALE

EUROPEAN PROJECTION

ISSUE DATE  
30-07-2009

REVISION  
06



**Published by**  
**Infineon Technologies AG**  
**81726 Munich, Germany**  
**© 2009 Infineon Technologies AG**  
**All Rights Reserved.**

**Legal Disclaimer**

The information given in this document shall in no event be regarded as a guarantee of conditions or characteristics. With respect to any examples or hints given herein, any typical values stated herein and/or any information regarding the application of the device, Infineon Technologies hereby disclaims any and all warranties and liabilities of any kind, including without limitation, warranties of non-infringement of intellectual property rights of any third party.

**Information**

For further information on technology, delivery terms and conditions and prices, please contact the nearest Infineon Technologies Office ([www.infineon.com](http://www.infineon.com)).

**Warnings**

Due to technical requirements, components may contain dangerous substances. For information on the types in question, please contact the nearest Infineon Technologies Office.

Infineon Technologies components may be used in life-support devices or systems only with the express written approval of Infineon Technologies, if a failure of such components can reasonably be expected to cause the failure of that life-support device or system or to affect the safety or effectiveness of that device or system. Life support devices or systems are intended to be implanted in the human body or to support and/or maintain and sustain and/or protect human life. If they fail, it is reasonable to assume that the health of the user or other persons may be endangered.