

VHF chokes with ferrite core
Rated voltage 250 V dc/ac
Rated current 0,2 to 2 A
Rated inductance 120 to 3900 μ H

Construction

- Ferrite cylinder core
- Winding: low-capacitance, multilayer, enamel copper wire
- Polyester insulating sleeve

Features

- High resonance frequency
- High inductance ratings

Applications

- RF blocking and filtering
- Interference suppression in small appliances

Marking
 L_R and I_R in clear text

Delivery mode

Bulk

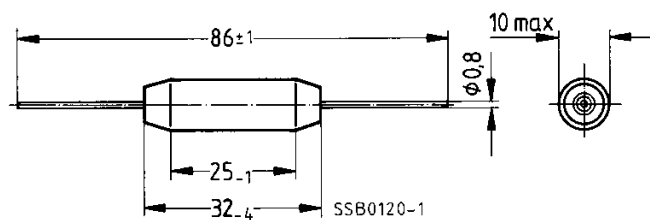
Dimensional drawing

Characteristics and ordering codes

 For further technical data [see page 194](#)

I_R	L_R	f_{res}	R_{typ}	Approx. weight	Ordering code
A	μH	MHz	Ω	g	
0,2	3900	1,8	20	7	B82500-C-A2
0,5	820	3,0	2,5	7	B82500-C-A5
1,0	330	4,2	0,6	7	B82500-C-A8
2,0	120	5,8	0,15	7	B82500-C-A10

Impedance $|Z|$
 versus frequency f
 (typical values)

B82500-C-

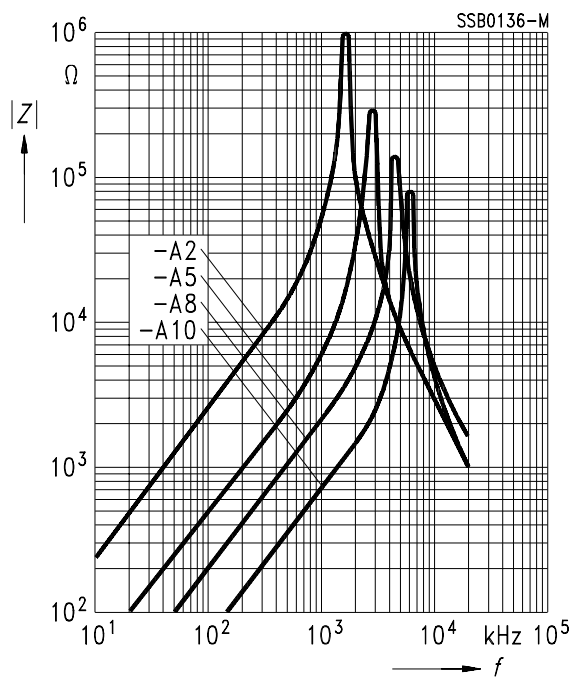

VHF chokes for power line applications
Rated voltage 500 V dc/ac¹⁾
Rated current max. 1 A

Construction

- Round 6-aperture ferrite core
- With or without insulating sleeve

Features

- The selected core material provides maximum impedance in the relevant frequency range of 50 to 200 MHz
- An insulating sleeve prevents any turn-to-turn short circuits

Applications

- Broadband interference suppression in electrical systems and equipment in the RF and VHF range
- Reduction of radiated interference in broadcasting and TV receivers

Delivery mode

Bulk

Dimensional drawing

Type B82114-R-A ... (without insulating sleeve)

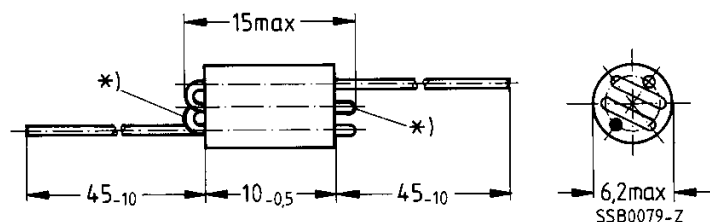

Type B82114-R-C ... (with insulating sleeve)

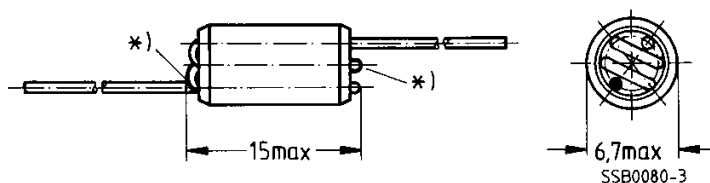
 Tinned leads,
 wire diameter 0,5 + 0,15 mm

1) 500 Vac only with insulating sleeve

*) Insulating sleeve

Technical data

Test voltage	2500 Vac, 1 min (only with insulation)
Rated current	max. 1 A
Climatic category	In accordance with IEC 60068-1 B82114-R-A: 55/120/21 (– 55 °C/+120 °C/21 days damp heat test) B82114-R-C: 55/125/56 (– 55 °C/+125 °C/56 days damp heat test)

Characteristics and ordering codes

f_{res} MHz	$ Z $ at f_{res} Ω	Color code	Number of turns	Gewicht ca. g	Version	Ordering code
60	900	brown	2,5	1,3	non-insulated insulated	B82114-R-A4 B82114-R-C4
100	800	green	2,5	1,3	non-insulated insulated	B82114-R-A1 B82114-R-C1

Impedance $|Z|$

 versus frequency f (typical values)

 I_V : dc magnetic bias

B82114-R-

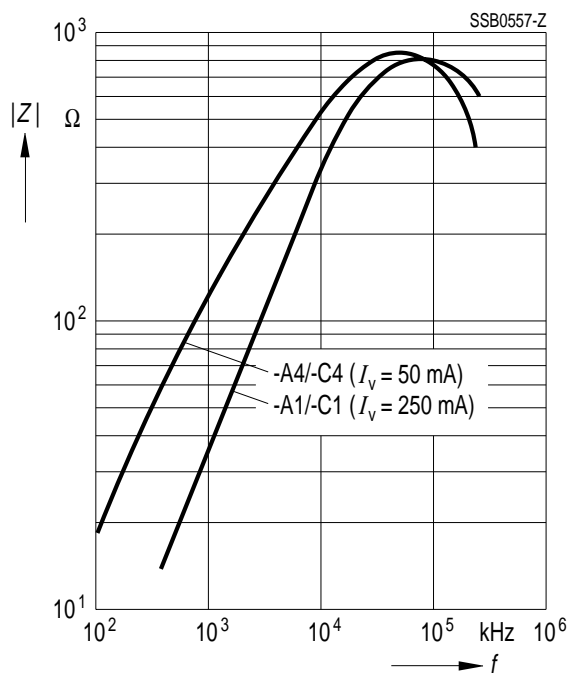

VHF Chokes

Packing

VHF chokes

Reel packing for type B82111-E (for taping see data sheet [page 198](#))

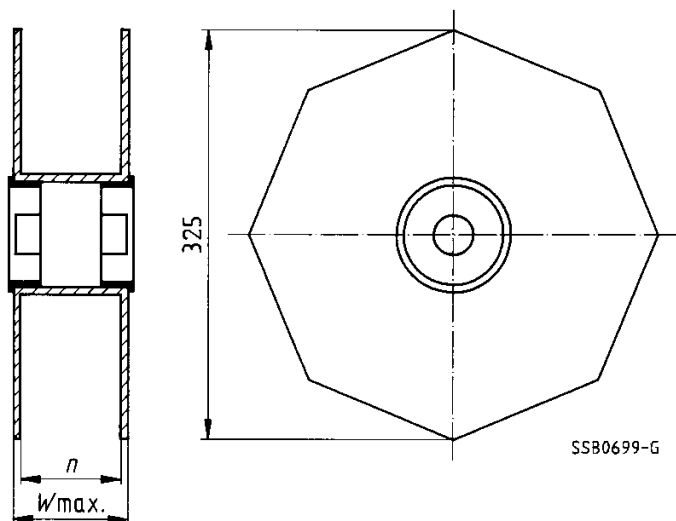

Reel packing for types B82131 ... B82134 (for taping see data sheet [page 195](#))

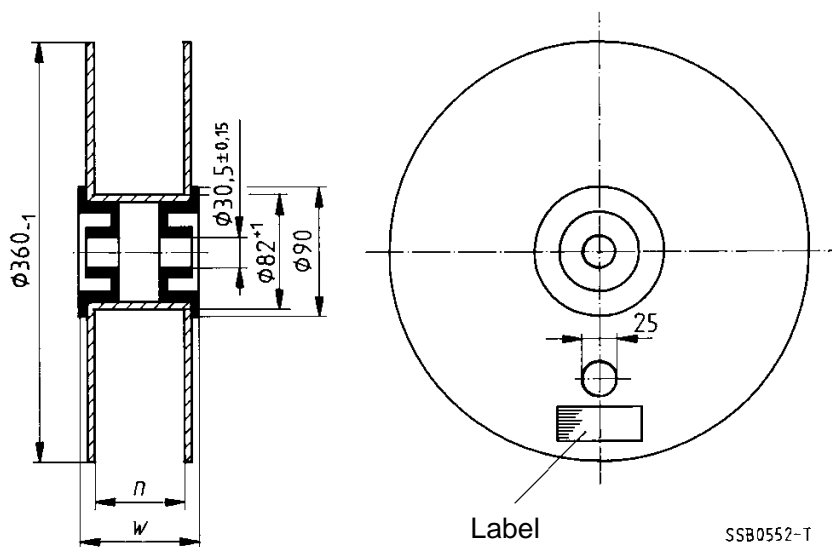

Type	Reel dimensions (mm)		Packing units
	$n + 1$	$W \text{ max.}$	Pieces/reel
B82111-E	97	109	1000
B82131, B82132	95	107	2000
B82133, B82134	95	107	1000

Vakatseite