

Overview

Features

- Driver for up to 3 motors
- Delivers up to 0.8 A continuous
- Optimized for DC motor management applications
- Very low current consumption in stand-by (Inhibit) mode
- Low saturation voltage; typ. 1.2 V total @ 25 °C; 0.4 A
- Output protected against short circuit
- Error flag diagnosis
- Overvoltage lockout and diagnosis
- Undervoltage lockout
- CMOS/TTL compatible inputs with hysteresis
- No crossover current
- Internal clamp diodes
- Overtemperature protection with hysteresis and diagnosis
- Enhanced power P-DSO-Package

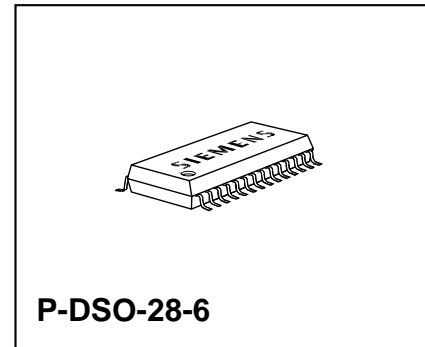

Type	Ordering Code	Package
TLE 4208 G	Q67007-A9335	P-DSO-28-6

Description

The TLE 4208 is a fully protected **Quad-Half-Bridge-Driver** designed specially for automotive and industrial motion control applications.

The part is built using the Siemens bipolar high voltage power technology DOPL.

In a cascade configuration up to three actuators (DC motors) can be connected between the four half-bridges. These four half-bridges are configured as 2 dual-half-bridges, which are supplied and controlled separately. Operation modes forward (cw), reverse (ccw), brake and high impedance are invoked from a standard interface.

The standard enhanced power P-DSO-28 package meets the application requirements and saves PCB-board space and costs.

Furthermore the built-in features like diagnosis, over- and undervoltage-lockout, short-circuit protection, over-temperature protection and the very low quiescent current in stand-by mode will open a wide range of automotive and industrial applications.

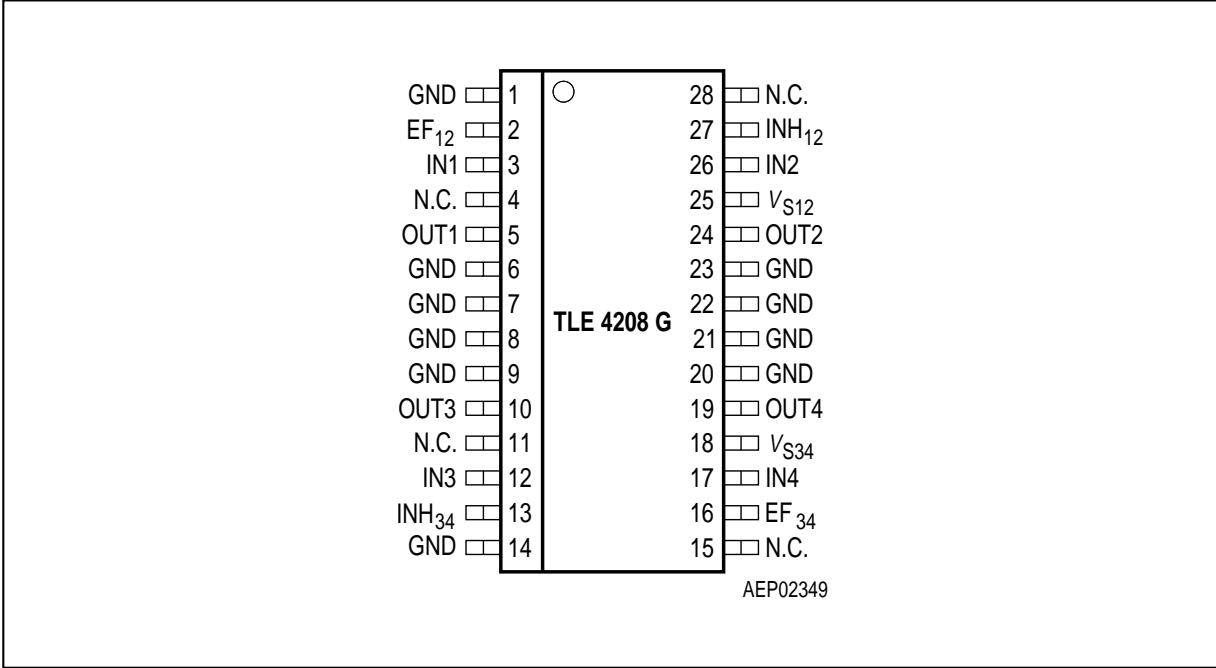

Figure 1 Pin Configuration (top view)

Pin Definitions and Functions

Pin No.	Symbol	Function
1, 6, 7, 8, 9, 14, 20, 21, 22, 23	GND	Ground; negative reference potential for blocking capacitor
2	EF ₁₂	Error Flag output of half-bridges 1 and 2; open collector; low = error
3	IN1	Input channel of half-bridge 1; controls OUT1
4, 11, 15, 28	N.C.	Not connected
5	OUT1	Power output of half-bridge 1; full short circuit protected; with integrated clamp diodes
10	OUT3	Power output of half-bridge 3; full short-circuit protected; with integrated clamp diodes
12	IN3	Input channel of half-bridge 3; controls OUT3
13	INH ₃₄	Inhibit input of half-bridges 3 and 4; low = half-bridges 3 and 4 in stand-by
16	EF ₃₄	Error Flag output of half-bridges 3 and 4; open collector; low = error
17	IN4	Input channel of half-bridge 4; controls OUT4
18	V _{S34}	Power supply voltage of half-bridges 3 and 4; positive reference potential for blocking capacitor
19	OUT4	Power output of half-bridge 4; full short circuit protected; with integrated clamp diodes
24	OUT2	Power-output of half-bridge 2; full short circuit protected; with integrated clamp diodes
25	V _{S12}	Power supply voltage of half-bridges 1 and 2; positive reference potential for blocking capacitor
26	IN2	Input channel of half-bridge 2; controls OUT2
27	INH ₁₂	Inhibit input of half-bridges 1 and 2; low = half-bridges 1 and 2 in stand-by

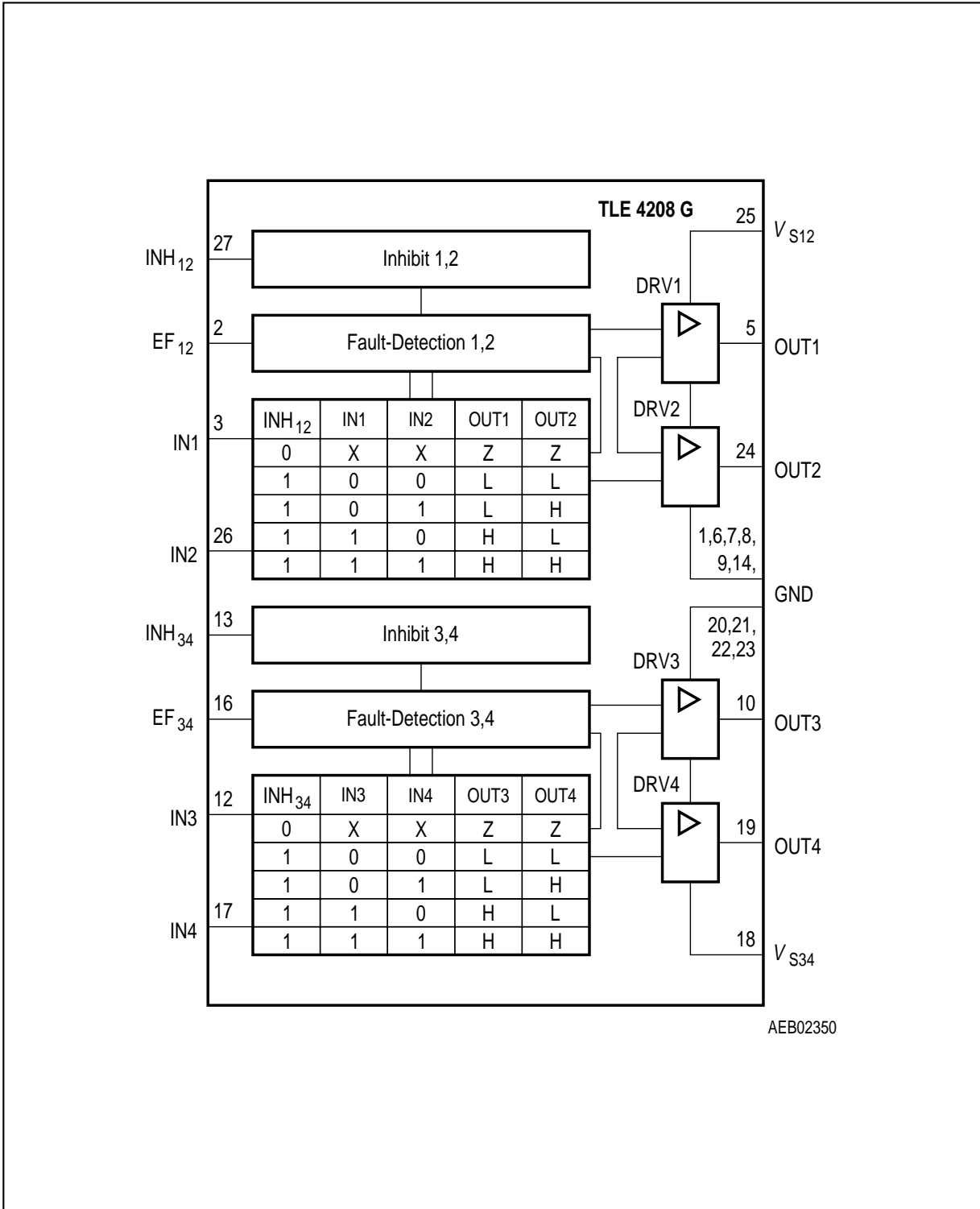

Figure 2 Block Diagram

Downloaded from Elcodis.com electronic components distributor

Input Logic

Functional Truth Table of Halfbridge 1 and 2

INH ₁₂	IN1	IN2	OUT1	OUT2	Mode
0	X	X	Z	Z	Stand-By
1	0	0	L	L	Brake LL
1	0	1	L	H	CW
1	1	0	H	L	CCW
1	1	1	H	H	Brake HH

Note: Half-Bridge 1 and 2 connected to a full-bridge

Functional Truth Table of Half-Bridge 3 and 4

INH ₃₄	IN3	IN4	OUT3	OUT4	Mode
0	X	X	Z	Z	Stand-By
1	0	0	L	L	Brake LL
1	0	1	L	H	CW
1	1	0	H	L	CCW
1	1	1	H	H	Brake HH

IN: 0 = Logic LOW
 1 = Logic HIGH
 X = don't care

OUT: Z = Output in tristate condition
 L = Output in sink condition
 H = Output in source condition

Note: Half-Bridge 3 and 4 connected to a full-bridge

Diagnosis

EF ₁₂	EF ₃₄	Error
1	1	no error
0	1	over temperature of half-bridge 1 and 2 or over voltage of half-bridge 1 and 2
0	1	over voltage of half-bridge 1 and 2
1	0	over temperature of half-bridge 3 and 4 or over voltage of half-bridge 3 and 4
1	0	over voltage of half-bridge 3 and 4
0	0	over temperature of all half-bridges or over voltage of all half-bridges
0	0	over voltage of all half-bridges

Electrical Characteristics

Absolute Maximum Ratings

Parameter	Symbol	Limit Values		Unit	Remarks
		min.	max.		

Voltages

Supply voltage	V_{S12}, V_{S34}	- 0.3	45	V	-
Supply voltage	V_{S12}, V_{S34}	- 1	-	V	$t < 0.5 \text{ s}; I_{S12}, I_{S34} > - 2 \text{ A}$
Logic input voltages (IN1; IN2; INH ₁₂ ; IN3; IN4; INH ₃₄)	V_I	- 5	20	V	$0\text{V} < V_{S12}, V_{S34} < 45 \text{ V}$
Logic output voltage (EF ₁₂ ; EF ₃₄)	V_{EF12}, V_{EF34}	- 0.3	20	V	$0 \text{ V} < V_{S12}, V_{S34} < 45 \text{ V}$

Currents

Output current (cont.)	I_{OUT1-4}	-	-	A	internally limited
Output current (peak)	I_{OUT1-4}	-	-	A	internally limited
Output current (diode)	I_{OUT1-4}	-1	1	A	-
Output current (EF)	$I_{EF12-34}$	-2	5	mA	-

Temperatures

Junction temperature	T_j	- 40	150	°C	-
Storage temperature	T_{stg}	- 50	150	°C	-

Thermal Resistances

Junction pin	$R_{thj-pin}$	-	25	K/W	measured to pin 7
Junction ambient	R_{thjA}	-	65	K/W	-

Note: Maximum ratings are absolute ratings; exceeding any one of these values may cause irreversible damage to the integrated circuit.

Operating Range

Parameter	Symbol	Limit Values		Unit	Remarks
		min.	max.		
Supply voltage	V_{S12}, V_{S34}	$V_{UV\ OFF}$	18	V	After V_{S12}, V_{S34} rising above $V_{UV\ ON}$
Supply voltage increasing	V_{S12}, V_{S34}	- 0.3	$V_{UV\ ON}$	V	Outputs in tristate
Supply voltage decreasing	V_{S12}, V_{S34}	- 0.3	$V_{UV\ OFF}$	V	Outputs in tristate
Logic input voltages (IN1; IN2; INH ₁₂ ; IN3; IN4; INH ₃₄)	V_I	- 2	18	V	-
Junction temperature	T_j	- 40	150	°C	-

Note: In the operating range the functions given in the circuit description are fulfilled.

Electrical Characteristics

8 V < $V_{S12} = V_{S34}$ < 18 V; $INH_{12} = INH_{34} = HIGH$; $I_{OUT1-4} = 0$ A; $-40\text{ °C} < T_j < 150\text{ °C}$; unless otherwise specified

Parameter	Symbol	Limit Values			Unit	Test Condition
		min.	typ.	max.		

Current Consumption

$INH_{12} = INH_{34} = LOW$

Quiescent current	I_S	–	–	100	μA	$I_S = I_{S12} + I_{S34}$
Quiescent current	I_S	–	20	40	μA	$I_S = I_{S12} + I_{S34}$; $V_{S12} = V_{S34} = 13.2\text{ V}$; $T_j = 25\text{ °C}$

$INH_{12} = HIGH$ and $INH_{34} = LOW$ or $INH_{12} = LOW$ and $INH_{34} = HIGH$

Supply current	I_{S12}, I_{S34}	–	10	20	mA	–
Supply current	I_{S12}, I_{S34}	–	–	30	mA	$I_{OUT1/3} = 0.4\text{ A}$ $I_{OUT2/4} = -0.4\text{ A}$
Supply current	I_{S12}, I_{S34}	–	–	50	mA	$I_{OUT1/3} = 0.8\text{ A}$ $I_{OUT2/4} = -0.8\text{ A}$

Over- and Under Voltage Lockout

UV Switch ON voltage	$V_{UV\ ON}$	–	6.5	7.5	V	V_{S12}, V_{S34} increasing
UV Switch OFF voltage	$V_{UV\ OFF}$	5	6	–	V	V_{S12}, V_{S34} decreasing
UV ON/OFF hysteresis	$V_{UV\ HY}$	–	0.5	–	V	$V_{UV\ ON} - V_{UV\ OFF}$
OV Switch OFF voltage	$V_{OV\ OFF}$	–	20	24	V	V_{S12}, V_{S34} increasing
OV Switch ON voltage	$V_{OV\ ON}$	18	19.5	–	V	V_{S12}, V_{S34} decreasing
OV ON/OFF hysteresis	$V_{OV\ HY}$	–	0.5	–	V	$V_{OV\ OFF} - V_{OV\ ON}$

Electrical Characteristics (cont'd)

8 V < $V_{S12} = V_{S34} < 18$ V; $INH_{12} = INH_{34} = HIGH$; $I_{OUT1-4} = 0$ A; -40 °C < $T_j < 150$ °C; unless otherwise specified

Parameter	Symbol	Limit Values			Unit	Test Condition
		min.	typ.	max.		

Outputs OUT1; OUT2; OUT 3; OUT 4

Saturation Voltages

Source (upper) $I_{OUT12}, I_{OUT34} = -0.2$ A	$V_{SAT U}$	–	0.85	1.15	V	$T_j = 25$ °C
Source (upper) $I_{OUT12}, I_{OUT34} = -0.4$ A	$V_{SAT U}$	–	0.90	1.20	V	$T_j = 25$ °C
Sink (upper) $I_{OUT12}, I_{OUT34} = -0.8$ A	$V_{SAT U}$	–	1.10	1.50	V	$T_j = 25$ °C
Sink (lower) $I_{OUT12}, I_{OUT34} = 0.2$ A	$V_{SAT L}$	–	0.15	0.23	V	$T_j = 25$ °C
Sink (lower) $I_{OUT12}, I_{OUT34} = 0.4$ A	$V_{SAT L}$	–	0.25	0.40	V	$T_j = 25$ °C
Sink (lower) $I_{OUT12}, I_{OUT34} = 0.8$ A	$V_{SAT L}$	–	0.45	0.75	V	$T_j = 25$ °C

Total Drop $I_{OUT12}, I_{OUT34} = 0.2$ A	V_{SAT}	–	1	1.4	V	$V_{SAT} = V_{SAT U} + V_{SAT L}$
Total Drop $I_{OUT12}, I_{OUT34} = 0.4$ A	V_{SAT}	–	1.2	1.7	V	$V_{SAT} = V_{SAT U} + V_{SAT L}$
Total Drop $I_{OUT12}, I_{OUT34} = 0.8$ A	V_{SAT}	–	1.6	2.5	V	$V_{SAT} = V_{SAT U} + V_{SAT L}$

Clamp Diodes

Forward voltage; upper	V_{FU}	–	1	1.5	V	$I_F = 0.4$ A
Upper leakage current	I_{LKU}	–	–	5	mA	$I_F = 0.4$ A ¹⁾
Forward voltage; lower	V_{FL}	–	0.9	1.4	V	$I_F = 0.4$ A

Notes see page 11.

Electrical Characteristics (cont'd)

8 V < $V_{S12} = V_{S34} < 18$ V; $INH_{12} = INH_{34} = HIGH$; $I_{OUT1-4} = 0$ A; -40 °C < $T_j < 150$ °C; unless otherwise specified

Parameter	Symbol	Limit Values			Unit	Test Condition
		min.	typ.	max.		

Input Interface

Logic Inputs IN1; IN2; IN3; IN4

H-input voltage	V_{IH}	–	2.0	3.0	V	–
L-input voltage	V_{IL}	1.0	1.5	–	V	–
Hysteresis of input voltage	V_{IHY}	–	0.5	–	V	–
H-input current	I_{IH}	– 2	–	10	μA	$V_I = 5$ V
L-input current	I_{IL}	– 100	– 20	– 5	μA	$V_I = 0$ V

Logic Inputs INH_{12} ; INH_{34}

H-input voltage	V_{IH}	–	2.7	3.5	V	–
L-input voltage	V_{IL}	1.0	2.0	–	V	–
Hysteresis of input voltage	V_{IHY}	–	0.7	–	V	–
H-input current	I_{IH}	–	100	250	μA	$V_{INH} = 5$ V
L-input current	I_{IL}	– 10	–	10	μA	$V_{INH} = 0$ V

Error-Flags EF_{12} ; EF_{34}

L-output voltage level	V_{EFL}	–	0.2	0.4	V	$I_{EF} = 2$ mA
Leakage current	I_{EFLK}	–	–	10	μA	0 V < $V_{EF} < 7$ V

Electrical Characteristics (cont'd)

$8\text{ V} < V_{S12} = V_{S34} < 18\text{ V}$; $\text{INH}_{12} = \text{INH}_{34} = \text{HIGH}$; $I_{\text{OUT}1-4} = 0\text{ A}$; $-40\text{ °C} < T_j < 150\text{ °C}$;
unless otherwise specified

Parameter	Symbol	Limit Values			Unit	Test Condition
		min.	typ.	max.		

Thermal Shutdown

Thermal shutdown junction temperature	T_{jSD}	150	175	200	°C	–
Thermal switch-on junction temperature	T_{jSO}	120	–	170	°C	–
Temperature hysteresis	ΔT	–	30	–	K	–

¹⁾ Guaranteed by design.

Note: The listed characteristics are ensured over the operating range of the integrated circuit. Typical characteristics specify mean values expected over the production spread. If not otherwise specified, typical characteristics apply at $T_A = 25\text{ °C}$ and the given supply voltage.

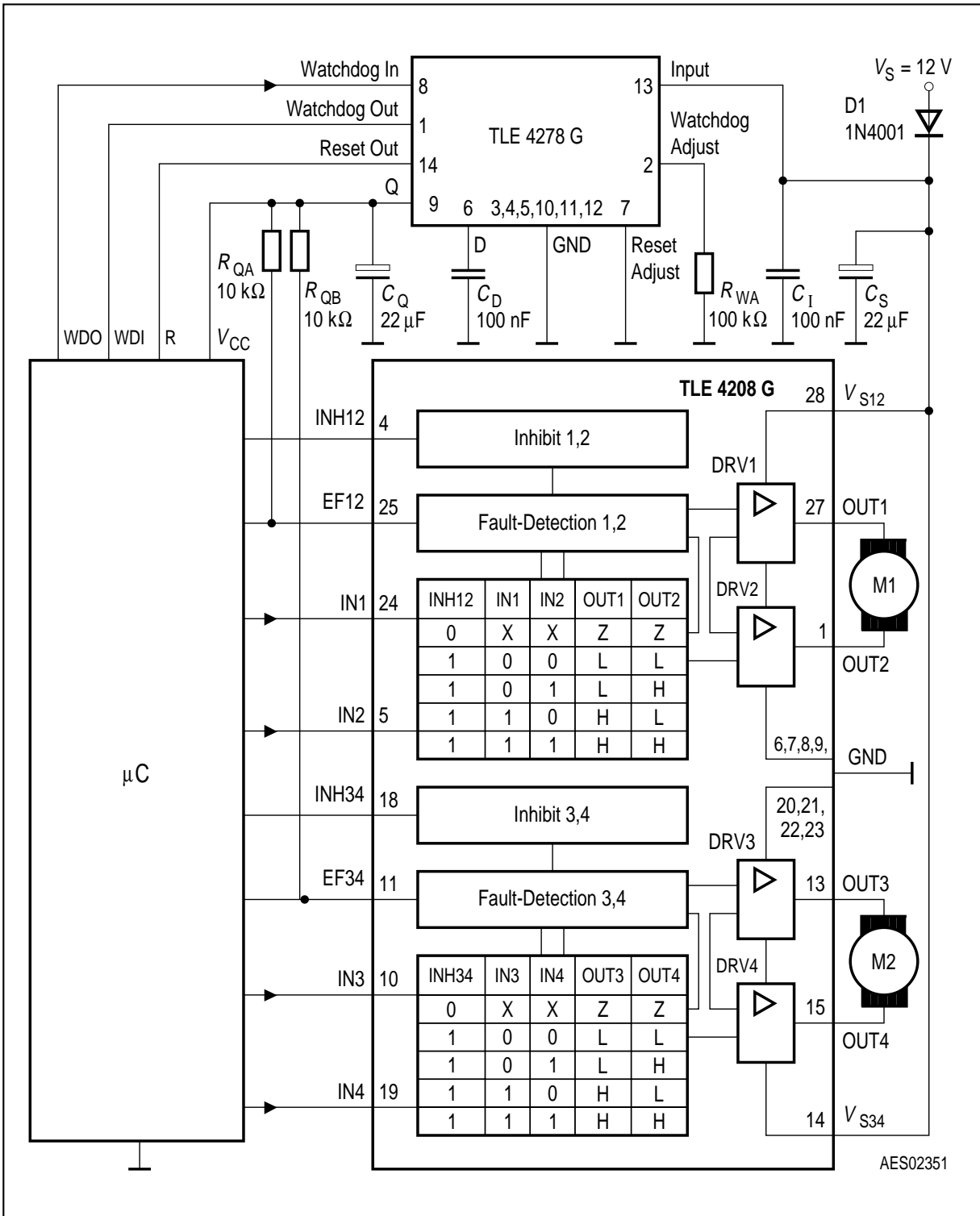
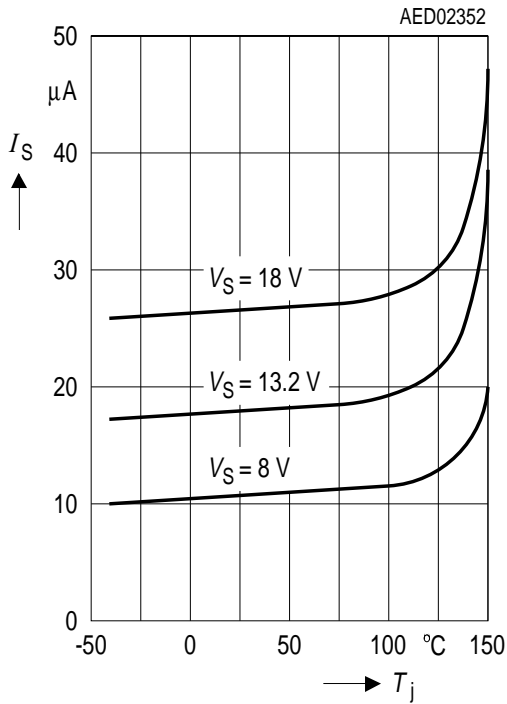

Figure 3 Application Circuit 1 (Device is used as Dual-Full-Bridge-Driver)

Diagrams

Quiescent current I_S over Temperature



Saturation Voltage of Source $V_{SAT U}$ over Temperature

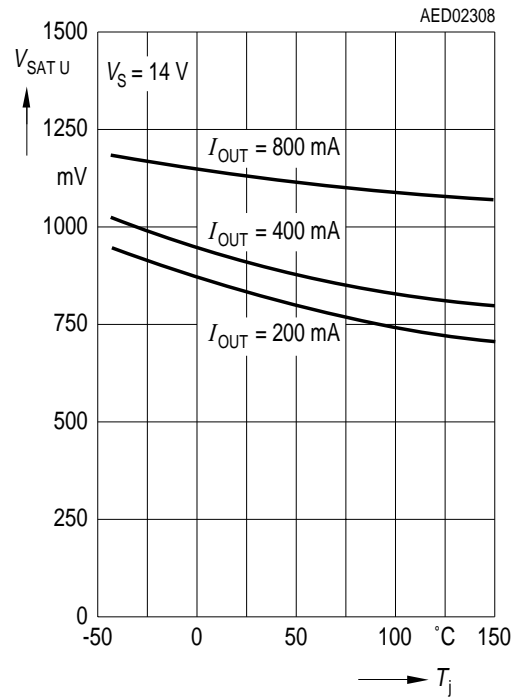

Saturation Voltage of Sink $V_{SAT L}$ over Temperature

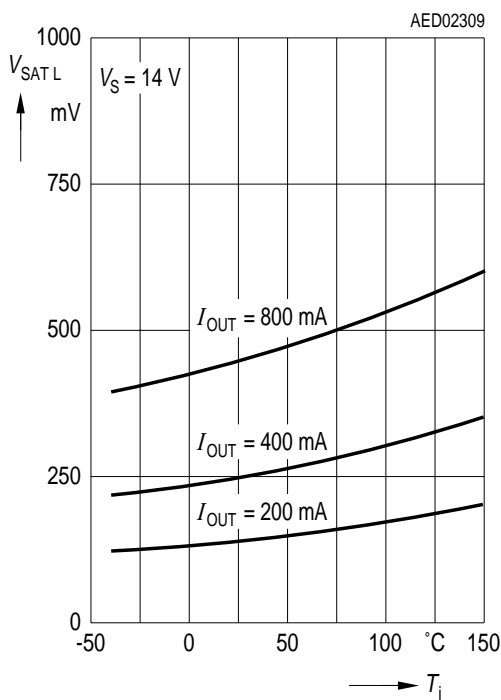

Total Drop at outputs V_{SAT} over Temperature

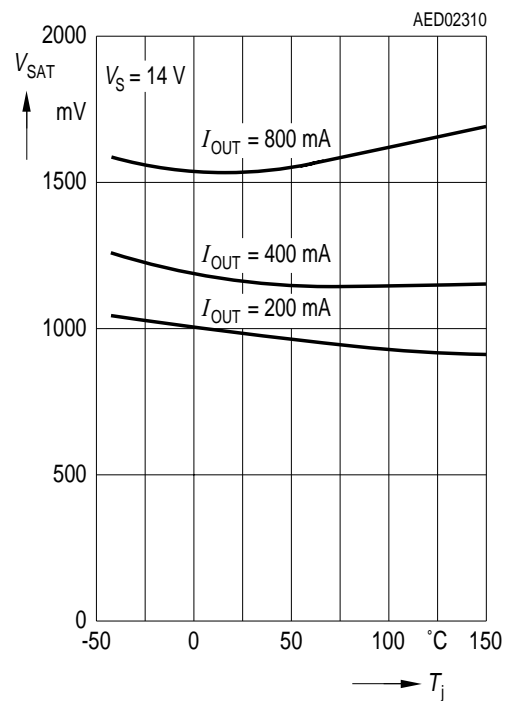

Package Outlines

P-DSO-28-6
(Plastic Dual Small Outline Package)

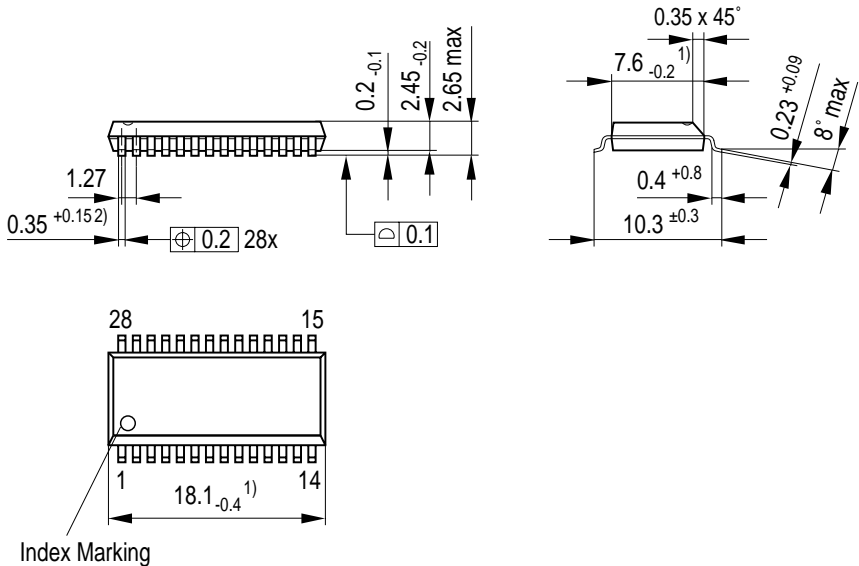

- 1) Does not include plastic or metal protrusions of 0.15 max per side
- 2) Does not include dambar protrusion of 0.05 max per side

GPS05123

Sorts of Packing

Package outlines for tubes, trays etc. are contained in our Data Book "Package Information".

SMD = Surface Mounted Device

Dimensions in mm