

# TSR-3306

## 微 調 電 位 器

- 單圈的/金屬陶瓷/工業用  
(Single Turn/ Cermet/ Industrial)
- 4 種引線的安裝尺寸  
(4 Terminal Styles)



電氣特性 Electrical Characteristics	
Standard Resistance Range	100Ω - 1MΩ
Resistance Tolerance	±30% std
Absolute Minimum Resistance	1% max (≤2K=30Ω)
Contact Resistance Variation	CRV≤3% max
Resistance	Essentially
Adjustment Angle	215° nom

環境特性 Environmental Characteristics	
Power Rating (50VCD max)	70°C, 0.3W
Temperature Range	-30°C ~ +100°C
Temperature Coefficient	±250ppm/°C
Load Life	1,000 hours 0.3W @70°C (3% ΔTR)

物理特性 Physical Characteristics	
Mechanical Angle	240±10°
Toque (Operating)	3.5oz-in.max
Stop Strength	7.0oz-in.max
Terminals	Solderable pins
Marking	Manufacturer's Trademark, resistance code, date code
Standard packaging	200pcs. Per bag
Adjustment Tool	H-90
Aqueous cleaning not recommended	

Top Adjust  
Common Dimensions

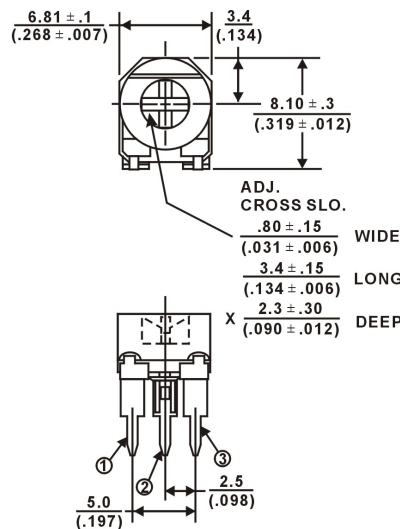

TSR-3306P

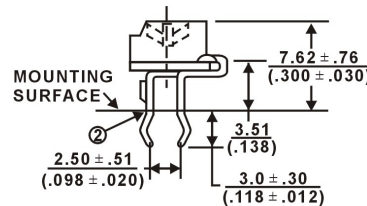

TSR-3306F

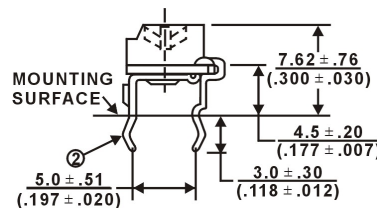

SUGGESTED PWB LAYOUT – STYLE F

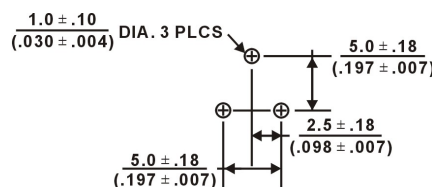

Side Adjust  
Common Dimensions

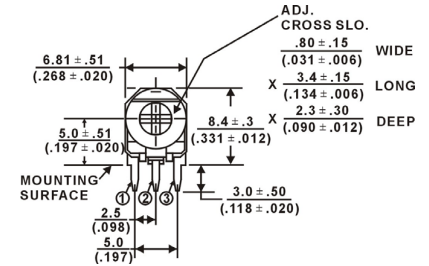

TSR-3306W

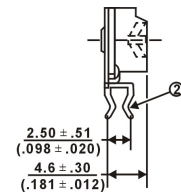

TSR-3306K

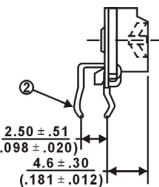

SUGGESTED PWB LAYOUT – STYLES K.P.W

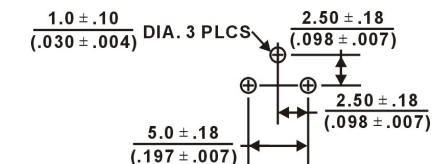

阻值代碼表

Standard Resistance table

Resistance(Ohms)	Resistance Code
100	101
200	201
500	501
1,000	102
2,000	202
5,000	502
10,000	103
20,000	203
25,000	253
50,000	503
100,000	104
200,000	204
250,000	254
500,000	504
1,000,000	105

可按用戶要求提供特殊規格  
Special resistances available.

### 訂購指南 How to Order

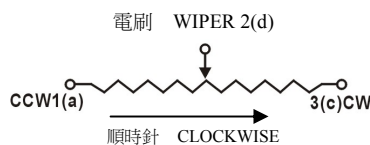
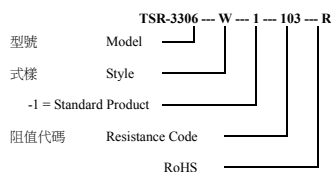

圖中公差：除注明外均為±0.25  
Tolerance is ±0.25 if no identification

Note: Specification are subject to change without notice. For more detail and update, please visit our website.