

**Low Noise Amplifier
1.7 - 2.0 GHz**

**MAAL-007673
V1**

Features

- Low Noise Figure: 1.65 dB
- High Gain: 20 dB
- Low Power Consumption: 3 to 5 V, 8 mA
- High Dynamic Range
- DC Decoupled RF Input and Output
- No External RF Tuning Elements Necessary
- Lead-Free Low Cost SOIC-8 Plastic Package
- 100% Matte Tin Plating over Copper
- Halogen-Free "Green" Mold Compound
- 260°C Reflow Compatible
- RoHS* Compliant Version of MAAM12031

Description

M/A-COM's MAAL-007673 is a high performance GaAs MMIC low noise amplifier in a lead-free SOIC 8-lead surface mount package. The MAAL-007673 employs a fully monolithic design which eliminates the need for external tuning networks. It can be biased using 3 or 5 volt supplies and has an option for biasing at higher currents for increased dynamic range.

The MAAL-007673 is ideally suited for use where low noise figure, high gain, high dynamic range and low power consumption are required. Typical applications include receiver front ends in the Japanese Personal Handy Phone Service (PHS), Private Branch Exchange (PBX) and Personal Communications and Networks (PCS, PCN) markets, as well as standard gain blocks, buffer amps, driver amps and IF amps in both fixed and portable systems.

M/A-COM's MAAL-007673 is fabricated using a mature 0.5-micron gate length GaAs process. The process features full passivation for increased performance reliability.

Ordering Information¹

Part Number	Package
MAAL-007673-000000	Bulk Packaging
MAAL-007673-TR1000	1000 piece reel
MAAL-007673-TR3000	3000 piece reel

1. Reference Application Note M513 for reel size information.

Functional Schematic

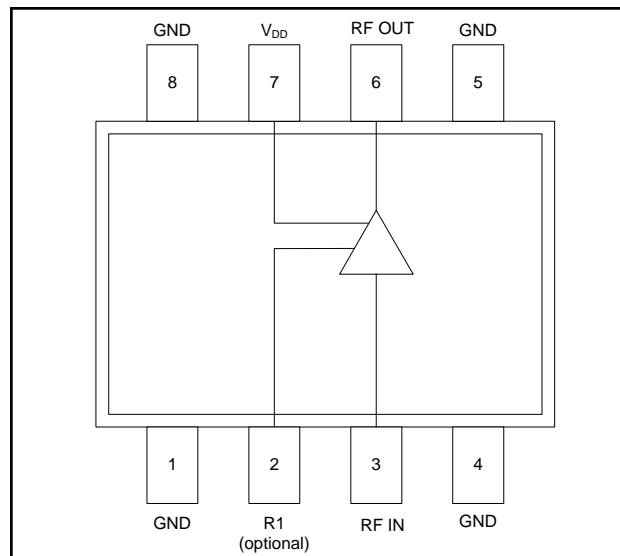

Pin Configuration

Pin No.	Function	Pin No.	Function
1	Ground	5	Ground
2	R1 (Optional)	6	RF Output
3	RF Input	7	V _{DD}
4	Ground	8	Ground

Absolute Maximum Ratings^{2,3}

Parameter	Absolute Maximum
V _{DD}	+10 VDC
Input Power	+17 dBm
Current ⁴	30 mA
Channel Temperature ⁵	+150°C
Operating Temperature	-40°C to +85°C
Storage Temperature	-65°C to +150°C

2. Exceeding any one or combination of these limits may cause permanent damage to this device.
3. M/A-COM does not recommend sustained operation near these survivability limits.
4. Only if pin 2 is used to increase current (see note 9).
5. Typical thermal resistance (θjc) = +165°C/W.

* Restrictions on Hazardous Substances, European Union Directive 2002/95/EC.

M/A-COM Inc. and its affiliates reserve the right to make changes to the product(s) or information contained herein without notice. M/A-COM makes no warranty, representation or guarantee regarding the suitability of its products for any particular purpose, nor does M/A-COM assume any liability whatsoever arising out of the use or application of any product(s) or information.

- **North America** Tel: 800.366.2266 / Fax: 978.366.2266
- **Europe** Tel: 44.1908.574.200 / Fax: 44.1908.574.300
- **Asia/Pacific** Tel: 81.44.844.8296 / Fax: 81.44.844.8298

Visit www.macom.com for additional data sheets and product information.

**Low Noise Amplifier
1.7 - 2.0 GHz**

**MAAL-007673
V1**

Electrical Specifications⁶: $T_A = 25^\circ\text{C}$, $V_{DD} = +5\text{ V}$, $Z_0 = 50\ \Omega$

Parameter	Test Conditions	Units	Min	Typ	Max
Gain	1.7 - 2.0 GHz, $P_{IN} = -30\text{ dBm}$	dB	18	20	22
Noise Figure	1.7 - 2.0 GHz	dB	—	1.65	2.00
Input VSWR	1.7 - 2.0 GHz, $P_{IN} = -30\text{ dBm}$	Ratio	—	1.7:1	—
Output VSWR	1.7 - 2.0 GHz, $P_{IN} = -30\text{ dBm}$	Ratio	—	1.7:1	—
Output 1 dB Compression	1.7 - 2.0 GHz	dBm	—	7	—
Input IP3	1.7 - 2.0 GHz, $P_{IN} = -30\text{ dBm}$	dBm	—	-1	—
Reverse Isolation	1.7 - 2.0 GHz, $P_{IN} = -30\text{ dBm}$	dB	—	38	—
Bias Current	—	mA	5	8	11

6. See plots for 3-volt performance.

Recommended PCB Configuration

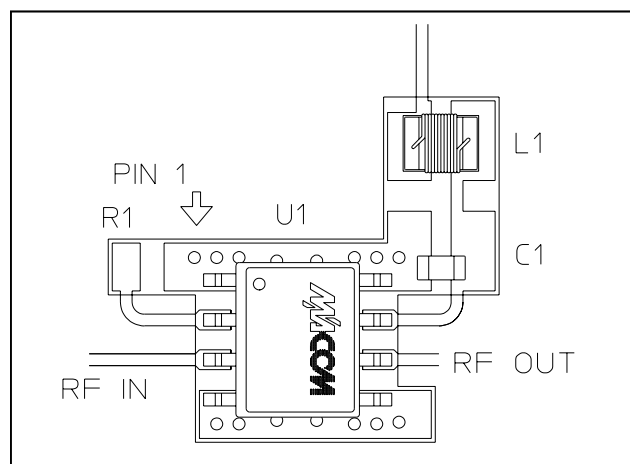

Application Schematic^{7,8,9}

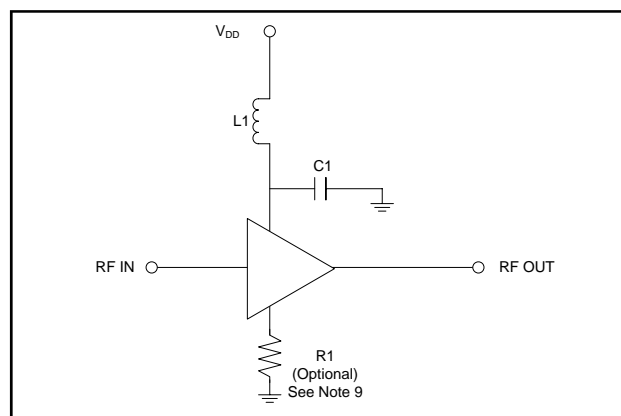

7. Pins 1, 4, 5 and 8 must be RF and DC grounded as shown.
8. Pin 3 is the RF input, pin 6 is the RF output. V_{DD} is applied on pin 7. This pin must be bypassed with a 500 pF surface mount MLC capacitor, mounted as close as possible to pin 7, and RF decoupled with a chip inductor having a minimum value of 15 nH (as shown in the Recommended PCB Configuration).
9. Pin 2 allows use of an external resistor to ground for optional, higher current bias. For nominal current operation no resistor is used. For optional 20 mA current operation, connect a 35 to 40 ohm chip resistor (as show in the Recommended PCB Configuration).

Component List

Part	Value	Case Size	Manufacturer
C1	500 pF	0603	Murata
L1	15 nH	0805	Coilcraft
R1 (Optional)	35 to 40 Ω	0603	Panasonic

Typical Performance Curves

Gain @ +25°C

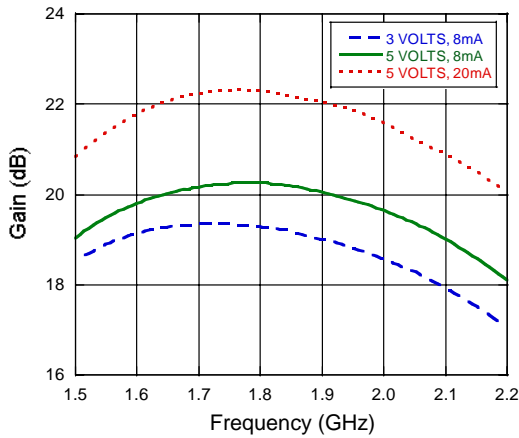

Noise Figure @ +25°C

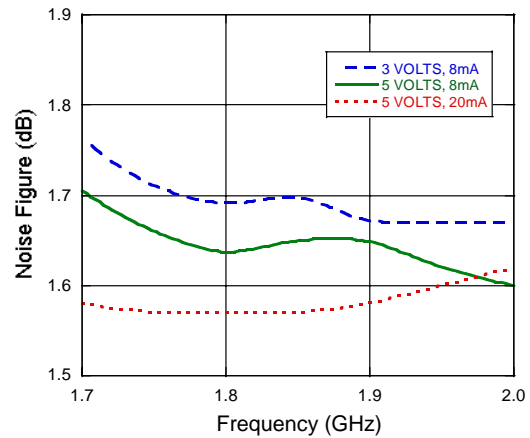

VSWR @ 5 V, 8 mA, +25°C

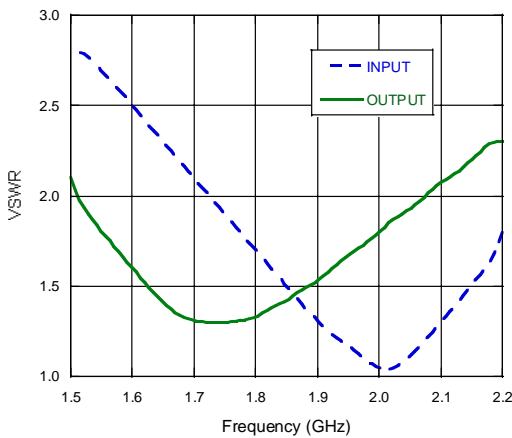

Input IP3 @ +25°C

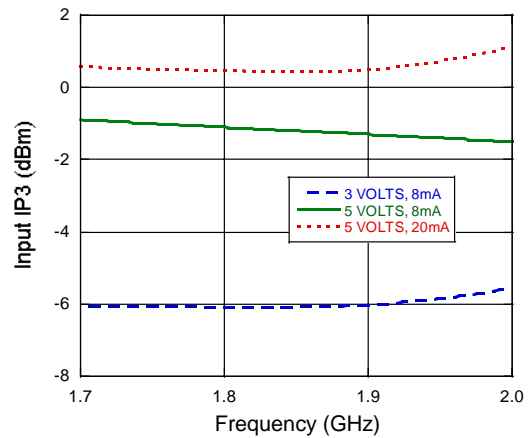

Gain @ 5 V, 8 mA

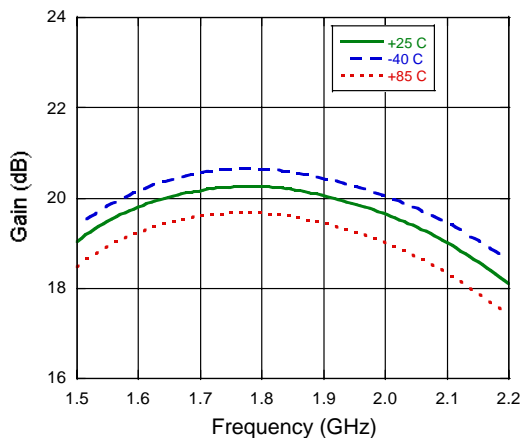

Noise Figure @ 5 V, 8 mA

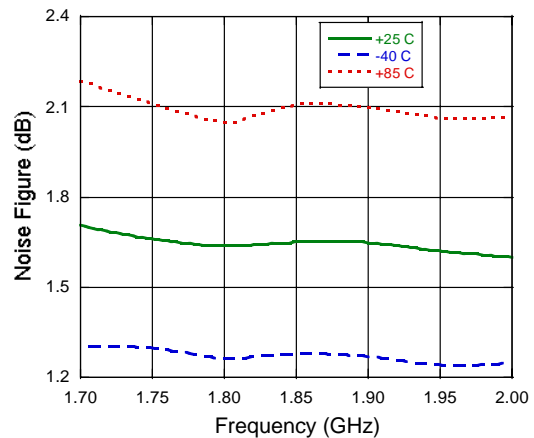

Lead-Free SOIC-8[†]

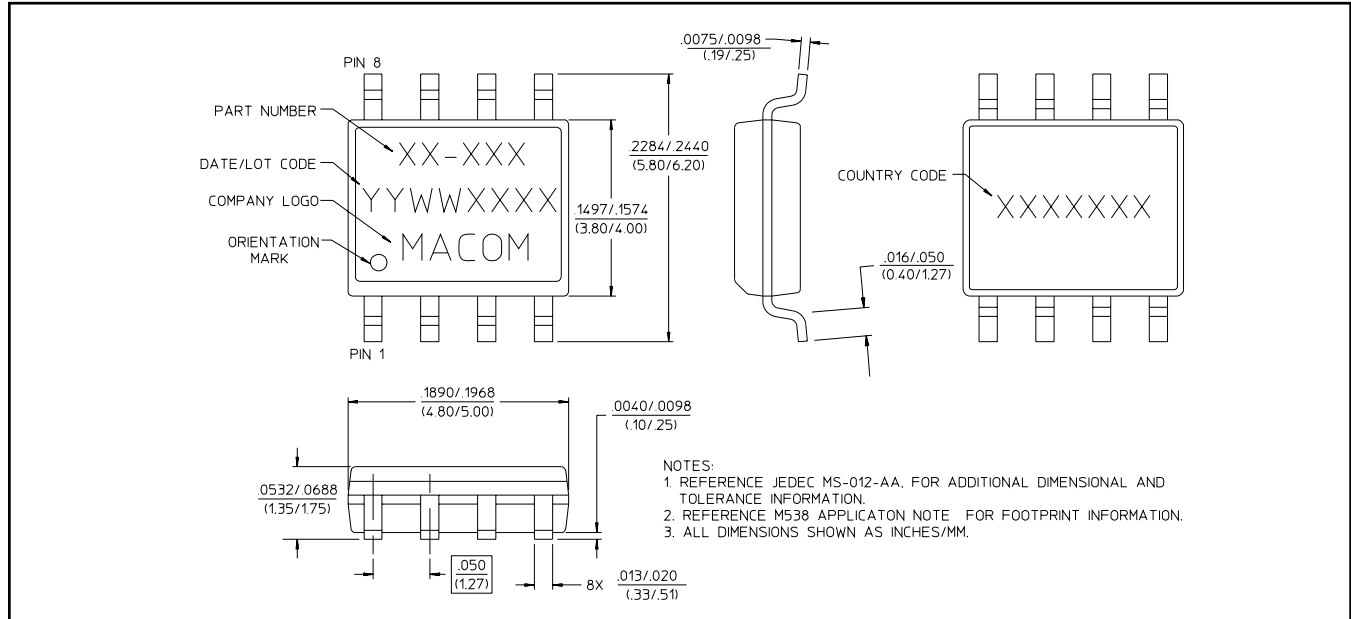

[†] Reference Application Note M538 for lead-free solder reflow recommendations.

Additional information is available in Application Note M540, "M/A-COM GaAs MMIC LNA SOIC-8 Platform".

Handling Procedures

Please observe the following precautions to avoid damage:

Static Sensitivity

Gallium Arsenide Integrated Circuits are sensitive to electrostatic discharge (ESD) and can be damaged by static electricity. Proper ESD control techniques should be used when handling these devices.