



# Frontier Electronics Corp.

667 E. COCHRAN STREET, SIMI VALLEY, CA 93065

TEL: (805) 522-9998 FAX: (805) 522-9989

E-mail: [frontiersales@frontierusa.com](mailto:frontiersales@frontierusa.com)

Web: <http://www.frontierusa.com>

## 1A FAST RECOVERY PLASTIC RECTIFIER

### FR10-005 THRU FR10-10

#### FEATURES

- FAST RECOVERY TIMES
- UL 94V0 FLAME RETARDANT EPOXY MOLDING COMPOUND
- DIFFUSED JUNCTION
- LOW COST
- HIGH SURGE CURRENT CAPABILITY

#### MECHANICAL DATA

- CASE: TRANSFER MOLDED, DO41, DIMENSIONS IN INCHES AND (MILLIMETERS)
- LEADS: SOLDERABLE PER MIL-STD-202, METHOD 208
- POLARITY: CATHODE INDICATED BY COLOR BAND
- WEIGHT: 0.34 GRAMS

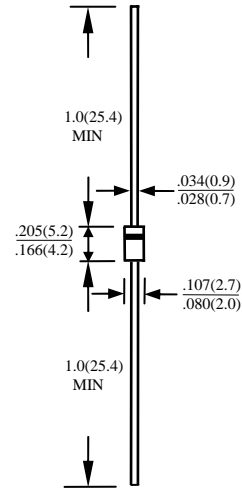

MAXIMUM RATINGS AND ELECTRICAL CHARACTERISTICS RATINGS AT 25°C AMBIENT TEMPERATURE UNLESS OTHERWISE SPECIFIED SINGLE PHASE, HALF WAVE, 60 HZ, RESISTIVE OR INDUCTIVE LOAD. FOR CAPACITIVE LOAD, DERATE CURRENT BY 20%

RATINGS	SYMBOL	FR10-005	FR10-01	FR10-02	FR10-04	FR10-06	FR10-08	FR10-10	UNITS
MAXIMUM RECURRENT PEAK REVERSE VOLTAGE	$V_{RRM}$	50	100	200	400	600	800	1000	V
MAXIMUM RMS VOLTAGE	$V_{RMS}$	35	70	140	280	420	560	700	V
MAXIMUM DC BLOCKING VOLTAGE	$V_{DC}$	50	100	200	400	600	800	1000	V
MAXIMUM AVERAGE FORWARD RECTIFIED CURRENT 0.375" (9.5mm) LEAD LENGTH AT $T_A=55^\circ\text{C}$	$I_O$	1.0							A
PEAK FORWARD SURGE CURRENT, 8.3ms SINGLE HALF SINE-WAVE SUPERIMPOSED ON RATED LOAD	$I_{FSM}$	30							A
TYPICAL JUNCTION CAPACITANCE (NOTE 1)	$C_J$	15							PF
TYPICAL THERMAL RESISTANCE (NOTE 2)	$R_{\theta ja}$	50							$^\circ\text{C}/\text{W}$
STORAGE TEMPERATURE RANGE	$T_{STG}$	- 55 TO + 150							$^\circ\text{C}$
OPERATING TEMPERATURE RANGE	$T_{OP}$	- 55 TO + 150							$^\circ\text{C}$

#### ELECTRICAL CHARACTERISTICS ( $A_T T_A=25^\circ\text{C}$ UNLESS OTHERWISE NOTED)

CHARACTERISTICS	SYMBOL	FR10-005	FR10-01	FR10-02	FR10-04	FR10-06	FR10-08	FR10-10	UNITS
MAXIMUM FORWARD VOLTAGE AT $I_O$ DC	$V_F$	1.3							V
MAXIMUM REVERSE CURRENT AT 25°C	$I_R$	5							$\mu\text{A}$
MAXIMUM REVERSE CURRENT AT 100°C	$I_R$	50							$\mu\text{A}$
MAXIMUM REVERSE RECOVERY TIME (NOTE 3)	$T_{RR}$	150			250		500		nS

- NOTE: 1. MEASURED AT 1 MHZ AND APPLIED REVERSE VOLTAGE OF 4.0 VOLTS  
 2. BOTH LEADS ATTACHED TO HEAT SINK 20x20x1t(mm) COPPER PLATE AT LEAD LENGTH 5mm  
 3. REVERSE RECOVERY TEST CONDITIONS:  $I_F=0.5\text{A}$ ,  $I_R=1.0\text{A}$ ,  $I_{RR}=0.25\text{A}$

# RATINGS AND CHARACTERISTIC CURVE FR10-005 THRU FR10-10

FIG. 1-TEST CIRCUIT DIAGRAM AND REVERSE RECOVERY TIME CHARACTERISTIC

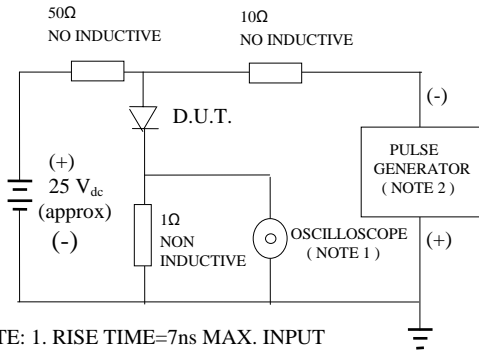

NOTE: 1. RISE TIME=7ns MAX. INPUT IMPEDANCE=1 MOhms 22PF  
 2. RISE TIME =10ns MAX. SOURCE IMPEDANCE=50 OHMS

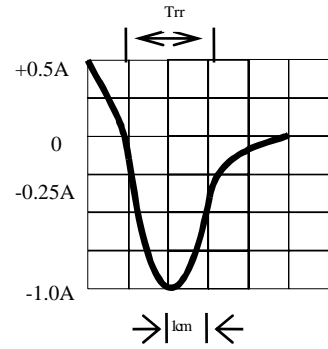

SET TIME BASE FOR 10/20 ns/cm

Fig. 2-MAXIMUM CURRENT DERATING CURVE

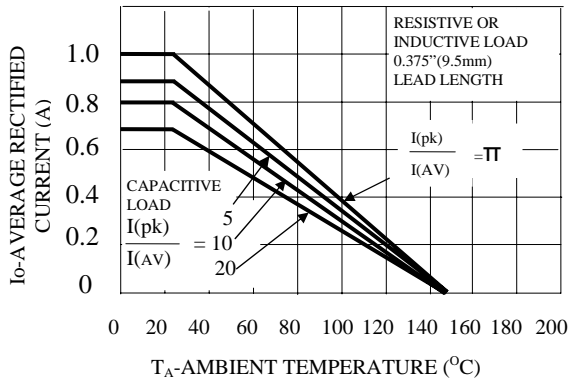

FIG. 3-TYPICAL JUNCTION CAPACITANCE

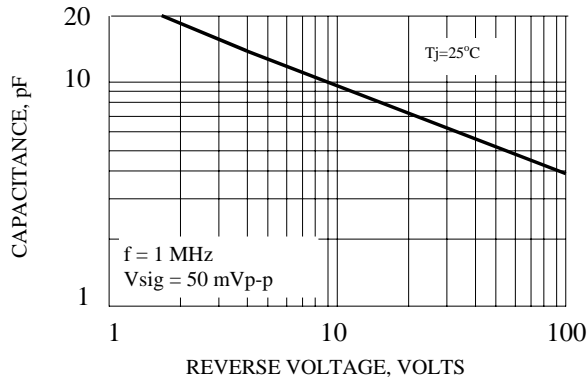

FIG. 4-TYPICAL REVERSE CHARACTERISTICS

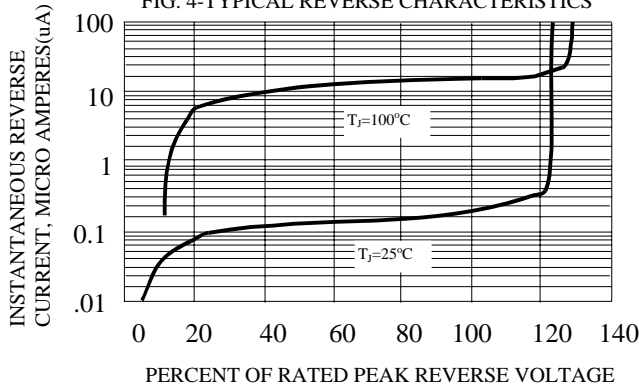

Fig. 5-MAXIMUM FORWARD SURGE NUMBER OF CYCLES

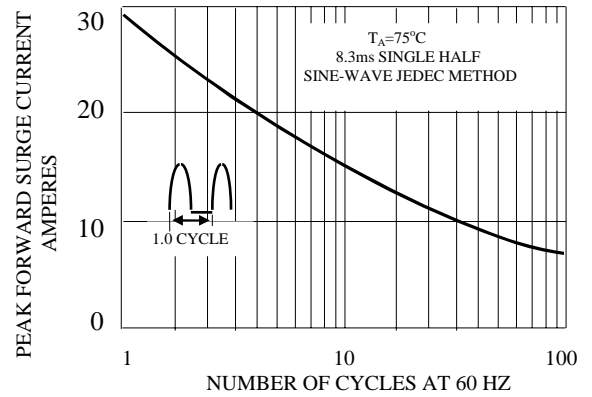

FIG. 6-TYPICAL INSTANTANEOUS FORWARD CHARACTERISTICS

