

IRFR3518
IRFU3518

HEXFET® Power MOSFET

Applications

- High frequency DC-DC converters

V_{DSS}	R_{DS(on)} max	I_D
80V	29mΩ	30A

Benefits

- Low Gate-to-Drain Charge to Reduce Switching Losses
- Fully Characterized Capacitance Including Effective C_{OSS} to Simplify Design, (See App. Note AN1001)
- Fully Characterized Avalanche Voltage and Current

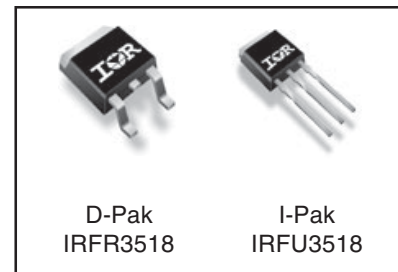

Absolute Maximum Ratings

	Parameter	Max.	Units
V _{DS}	Drain-to-Source Voltage	80	V
V _{GS}	Gate-to-Source Voltage	± 20	
I _D @ T _C = 25°C	Continuous Drain Current, V _{GS} @ 10V	38	A
I _D @ T _C = 100°C	Continuous Drain Current, V _{GS} @ 10V	27	
I _{DM}	Pulsed Drain Current ①	150	
P _D @ T _C = 25°C	Power Dissipation	110	W
	Linear Derating Factor	0.71	W/°C
dv/dt	Peak Diode Recovery dv/dt ②	5.2	V/ns
T _J	Operating Junction and	-55 to + 175	°C
T _{STG}	Storage Temperature Range		
	Soldering Temperature, for 10 seconds	300 (1.6mm from case)	

Thermal Resistance

	Parameter	Typ.	Max.	Units
R _{θJC}	Junction-to-Case	—	1.4	°C/W
R _{θJA}	Junction-to-Ambient (PCB mount)③	—	40	
R _{θJA}	Junction-to-Ambient	—	110	

Notes ① through ③ are on page 10
www.irf.com

IRFR3518/IRFU3518

International
IR Rectifier

Static @ $T_J = 25^\circ\text{C}$ (unless otherwise specified)

	Parameter	Min.	Typ.	Max.	Units	Conditions
$V_{(BR)DSS}$	Drain-to-Source Breakdown Voltage	80	—	—	V	$V_{GS} = 0V, I_D = 250\mu A$
$\Delta V_{(BR)DSS}/\Delta T_J$	Breakdown Voltage Temp. Coefficient	—	0.09	—	V/°C	Reference to $25^\circ\text{C}, I_D = 1\text{mA}$ ⑥
$R_{DS(on)}$	Static Drain-to-Source On-Resistance	—	24	29	mΩ	$V_{GS} = 10V, I_D = 18A$ ④
$V_{GS(th)}$	Gate Threshold Voltage	2.0	—	4.0	V	$V_{DS} = V_{GS}, I_D = 250\mu A$
I_{DSS}	Drain-to-Source Leakage Current	—	—	20	μA	$V_{DS} = 80V, V_{GS} = 0V$
		—	—	250		$V_{DS} = 64V, V_{GS} = 0V, T_J = 150^\circ\text{C}$
I_{GSS}	Gate-to-Source Forward Leakage	—	—	200	nA	$V_{GS} = 20V$
	Gate-to-Source Reverse Leakage	—	—	-200		$V_{GS} = -20V$

Dynamic @ $T_J = 25^\circ\text{C}$ (unless otherwise specified)

	Parameter	Min.	Typ.	Max.	Units	Conditions
g_{fs}	Forward Transconductance	34	—	—	S	$V_{DS} = 25V, I_D = 18A$
Q_g	Total Gate Charge	—	37	56	nC	$I_D = 18A$ $V_{DS} = 40V$ $V_{GS} = 10V$ ④
Q_{gs}	Gate-to-Source Charge	—	11	—		
Q_{gd}	Gate-to-Drain ("Miller") Charge	—	12	—		
$t_{d(on)}$	Turn-On Delay Time	—	12	—	ns	$V_{DD} = 40V$ $I_D = 18A$ $R_G = 9.1\Omega$ $V_{GS} = 10V$ ④
t_r	Rise Time	—	25	—		
$t_{d(off)}$	Turn-Off Delay Time	—	37	—		
t_f	Fall Time	—	13	—		
C_{iss}	Input Capacitance	—	1710	—	pF	$V_{GS} = 0V$ $V_{DS} = 25V$ $f = 1.0\text{MHz}$ $V_{GS} = 0V, V_{DS} = 1.0V, f = 1.0\text{MHz}$ $V_{GS} = 0V, V_{DS} = 64V, f = 1.0\text{MHz}$ $V_{GS} = 0V, V_{DS} = 0V \text{ to } 64V$ ⑤
C_{oss}	Output Capacitance	—	270	—		
C_{rss}	Reverse Transfer Capacitance	—	33	—		
C_{oss}	Output Capacitance	—	1780	—		
C_{oss}	Output Capacitance	—	170	—		
$C_{oss \text{ eff.}}$	Effective Output Capacitance	—	330	—		

Avalanche Characteristics

	Parameter	Typ.	Max.	Units
E_{AS}	Single Pulse Avalanche Energy②	—	160	mJ
I_{AR}	Avalanche Current①	—	18	A
E_{AR}	Repetitive Avalanche Energy①	—	11	mJ

Diode Characteristics

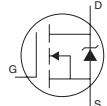
	Parameter	Min.	Typ.	Max.	Units	Conditions
I_S	Continuous Source Current (Body Diode)	—	—	38	A	MOSFET symbol showing the integral reverse p-n junction diode. 
I_{SM}	Pulsed Source Current (Body Diode) ①	—	—	150		
V_{SD}	Diode Forward Voltage	—	—	1.3	V	$T_J = 25^\circ\text{C}, I_S = 18A, V_{GS} = 0V$ ④
t_{rr}	Reverse Recovery Time	—	77	—	ns	$T_J = 25^\circ\text{C}, I_F = 18A$
Q_{rr}	Reverse Recovery Charge	—	210	—	nC	$di/dt = 100A/\mu s$ ④
t_{on}	Forward Turn-On Time	Intrinsic turn-on time is negligible (turn-on is dominated by $L_S + L_D$)				

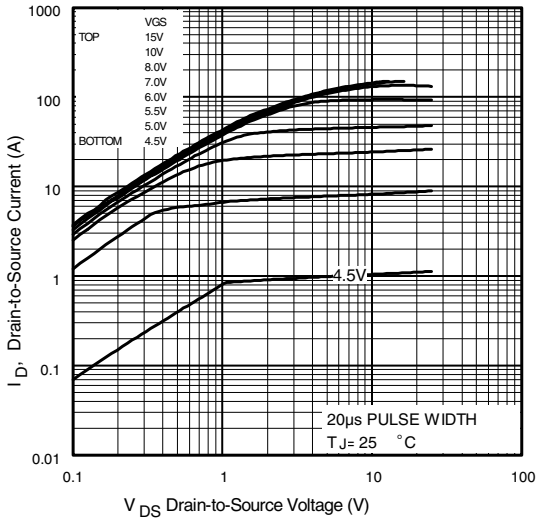

Fig 1. Typical Output Characteristics

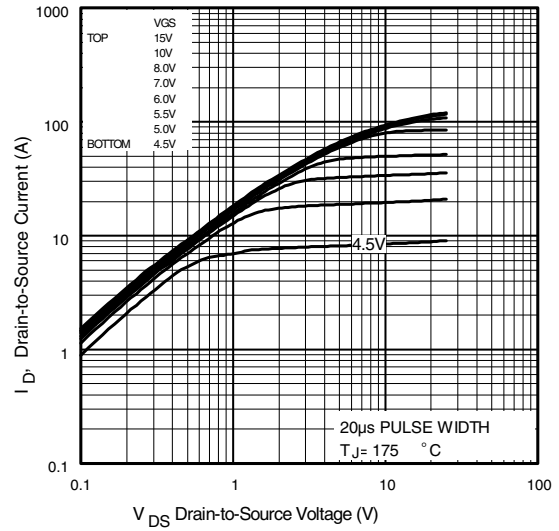

Fig 2. Typical Output Characteristics

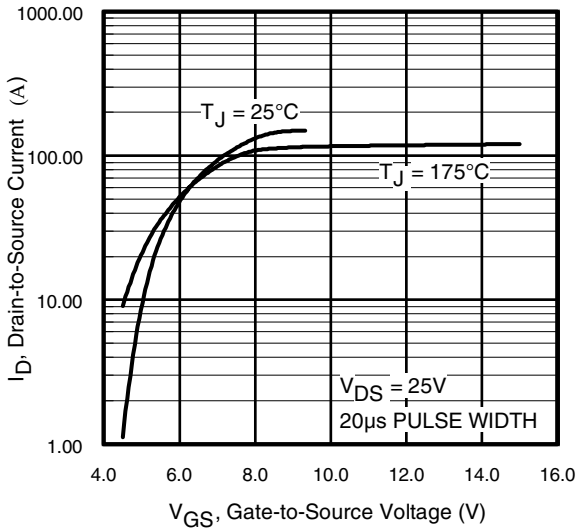

Fig 3. Typical Transfer Characteristics

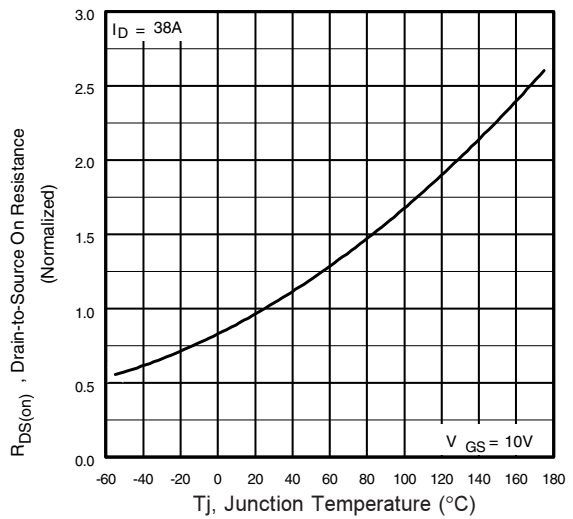

Fig 4. Normalized On-Resistance Vs. Temperature

IRFR3518/IRFU3518

International
IR Rectifier

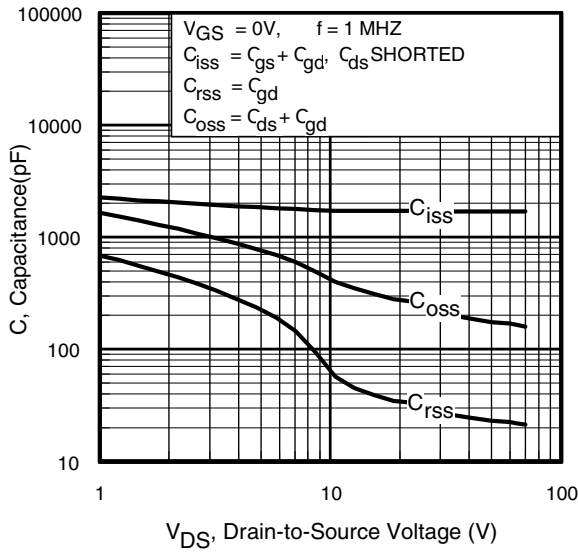

Fig 5. Typical Capacitance Vs. Drain-to-Source Voltage

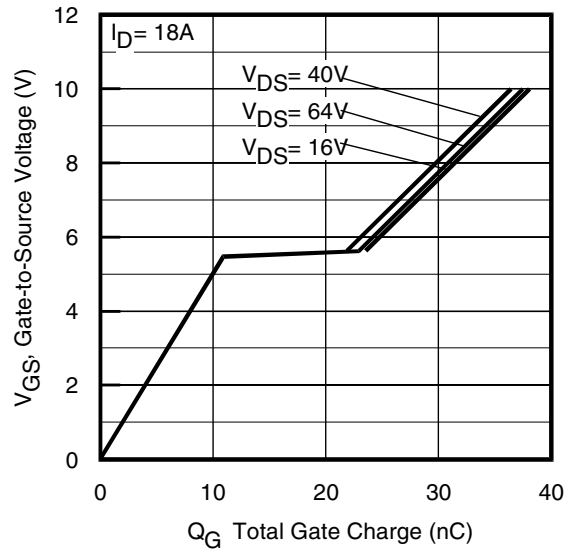

Fig 6. Typical Gate Charge Vs. Gate-to-Source Voltage

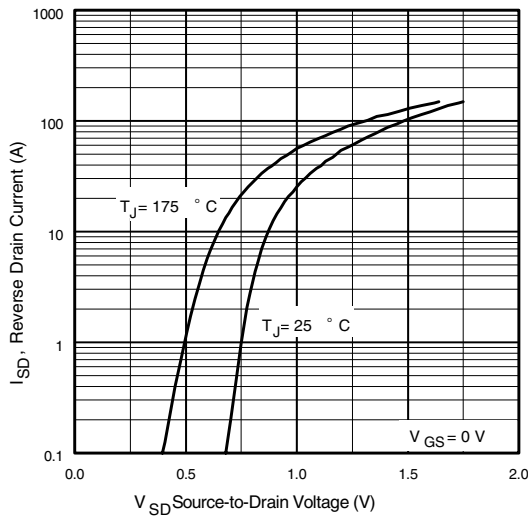

Fig 7. Typical Source-Drain Diode Forward Voltage

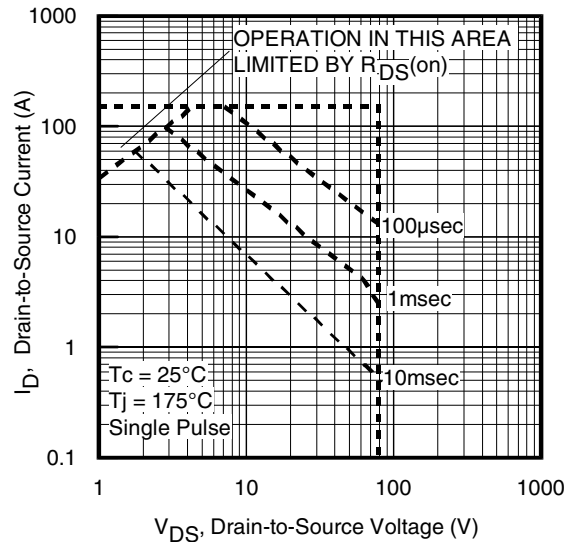

Fig 8. Maximum Safe Operating Area

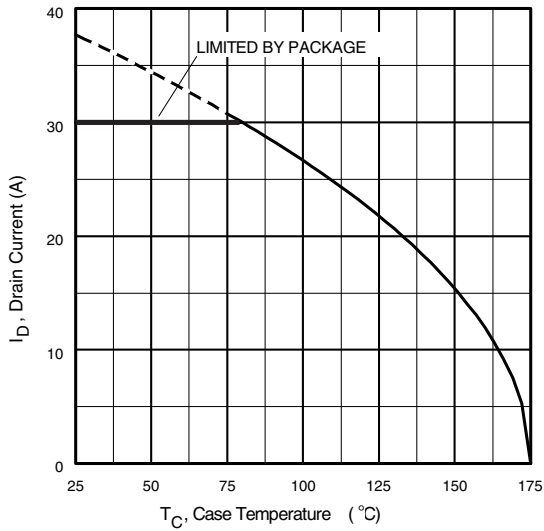

Fig 9. Maximum Drain Current Vs. Case Temperature

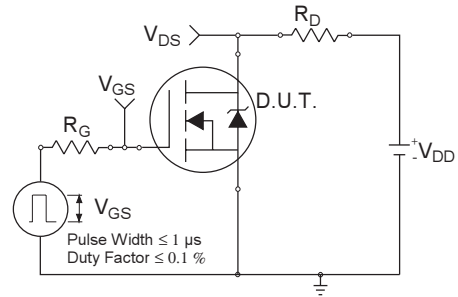

Fig 10a. Switching Time Test Circuit

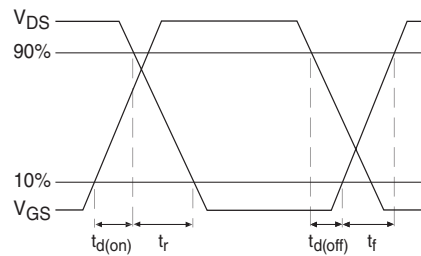

Fig 10b. Switching Time Waveforms

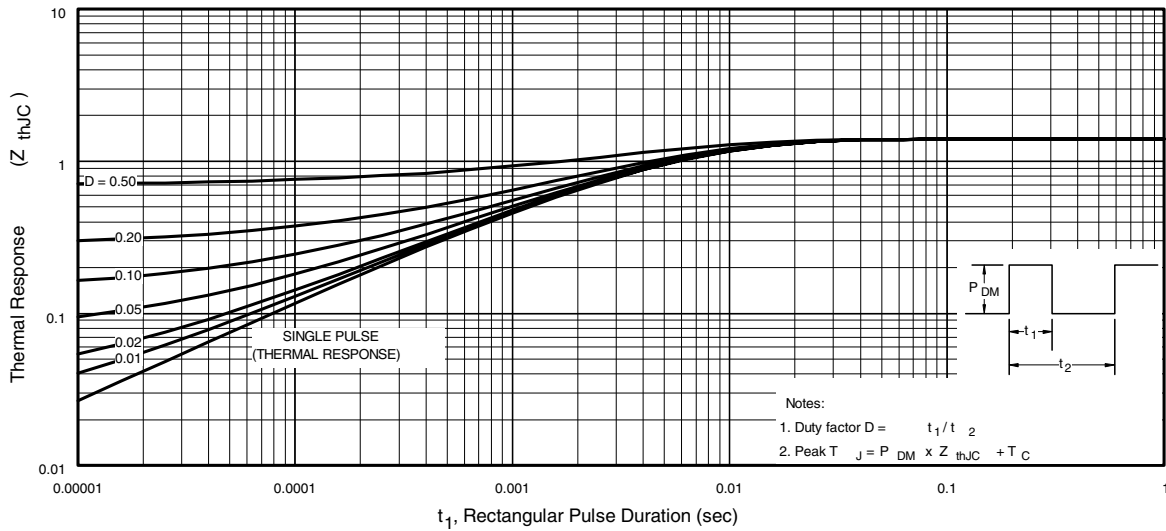

Fig 11. Maximum Effective Transient Thermal Impedance, Junction-to-Case

IRFR3518/IRFU3518

International
IR Rectifier

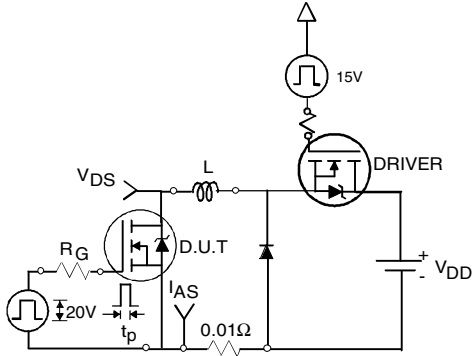

Fig 12a. Unclamped Inductive Test Circuit

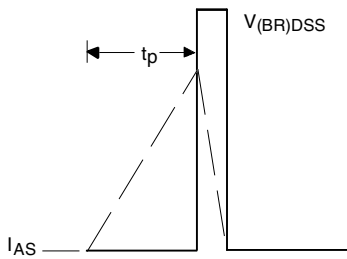

Fig 12b. Unclamped Inductive Waveforms

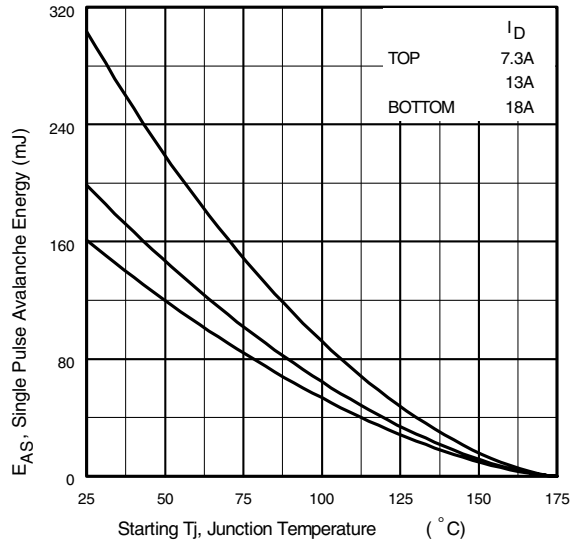

Fig 12c. Maximum Avalanche Energy Vs. Drain Current

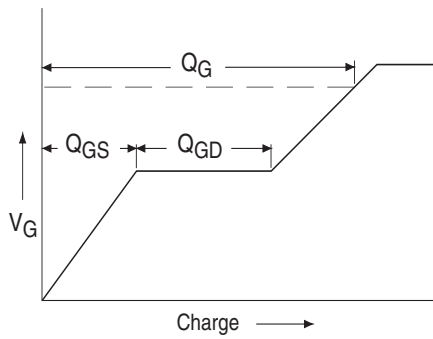

Fig 13a. Basic Gate Charge Waveform

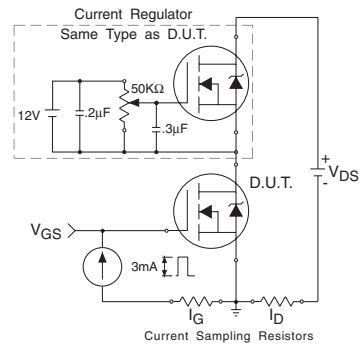
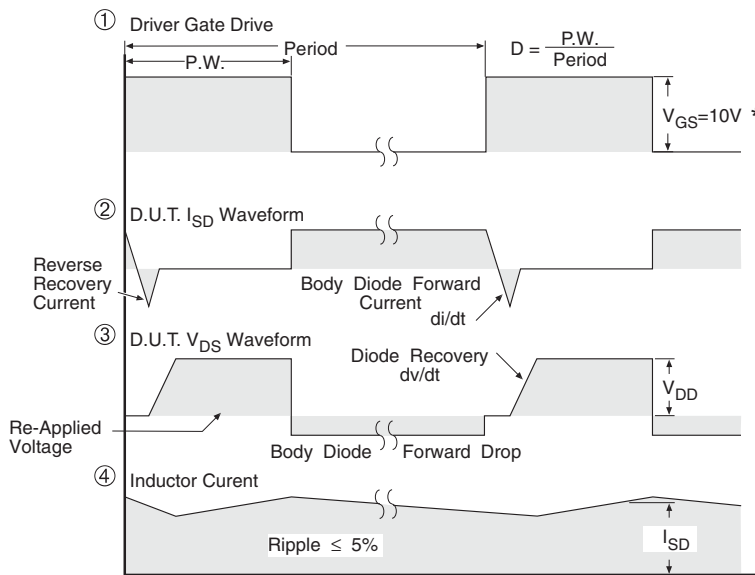
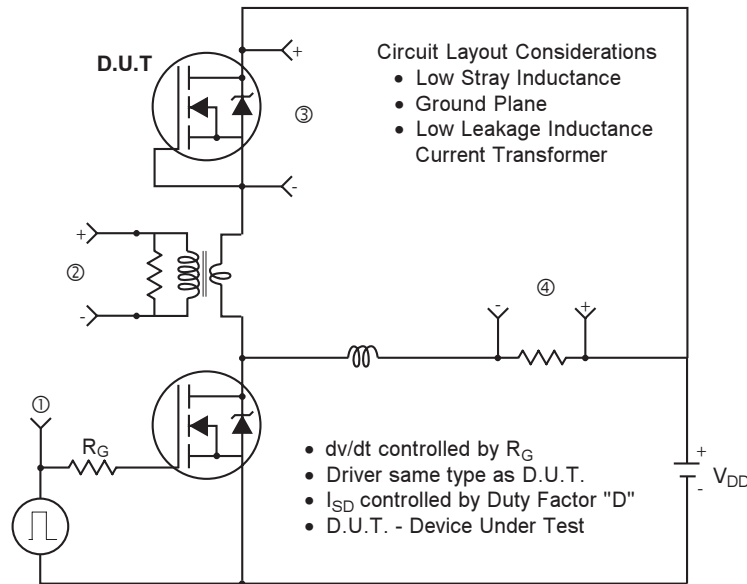

Fig 13b. Gate Charge Test Circuit

Peak Diode Recovery dv/dt Test Circuit



* $V_{GS} = 5V$ for Logic Level Devices

Fig 14. For N-Channel HEXFET® Power MOSFETs

IRFR3518/IRFU3518

D-Pak (TO-252AA) Package Outline

Dimensions are shown in millimeters (inches)

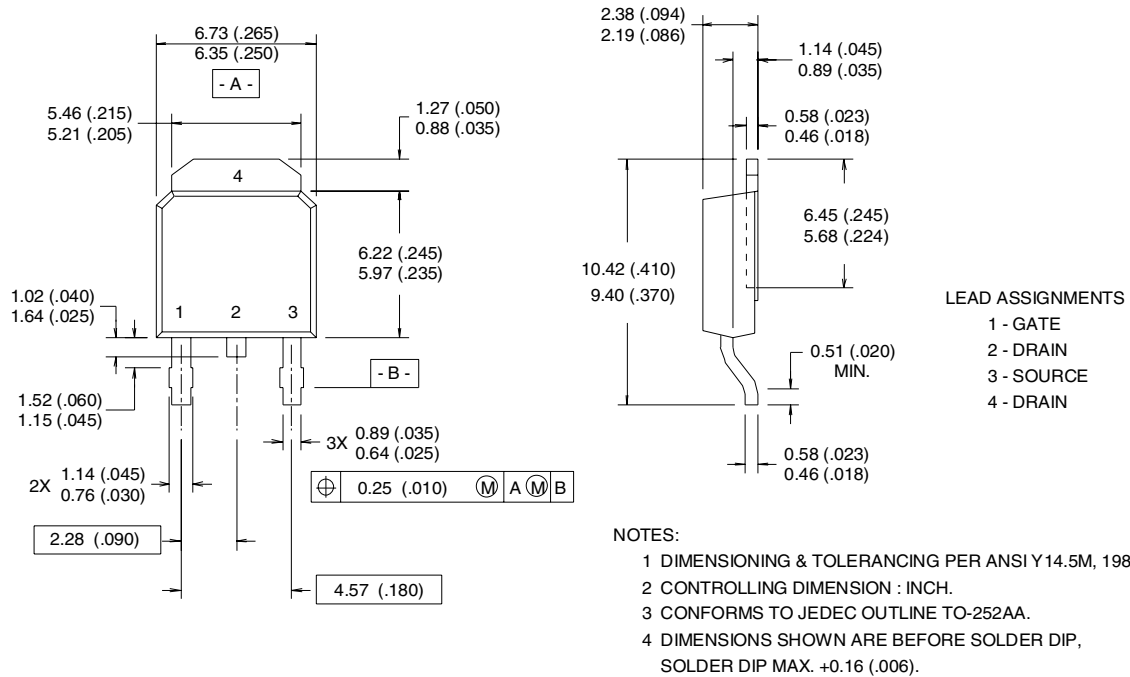

D-Pak (TO-252AA) Part Marking Information

EXAMPLE: THIS IS AN IRFR120
LOT CODE 1789
ASSEMBLED ON WW 19, 1997
IN THE ASSEMBLY LINE "C"

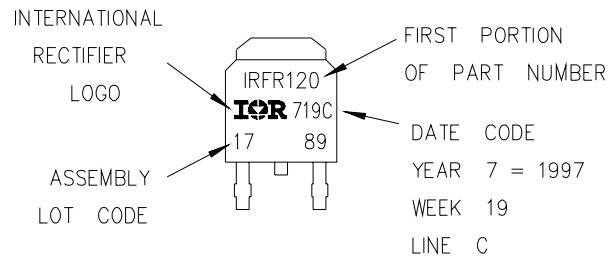

I-Pak (TO-251AA) Package Outline

Dimensions are shown in millimeters (inches)

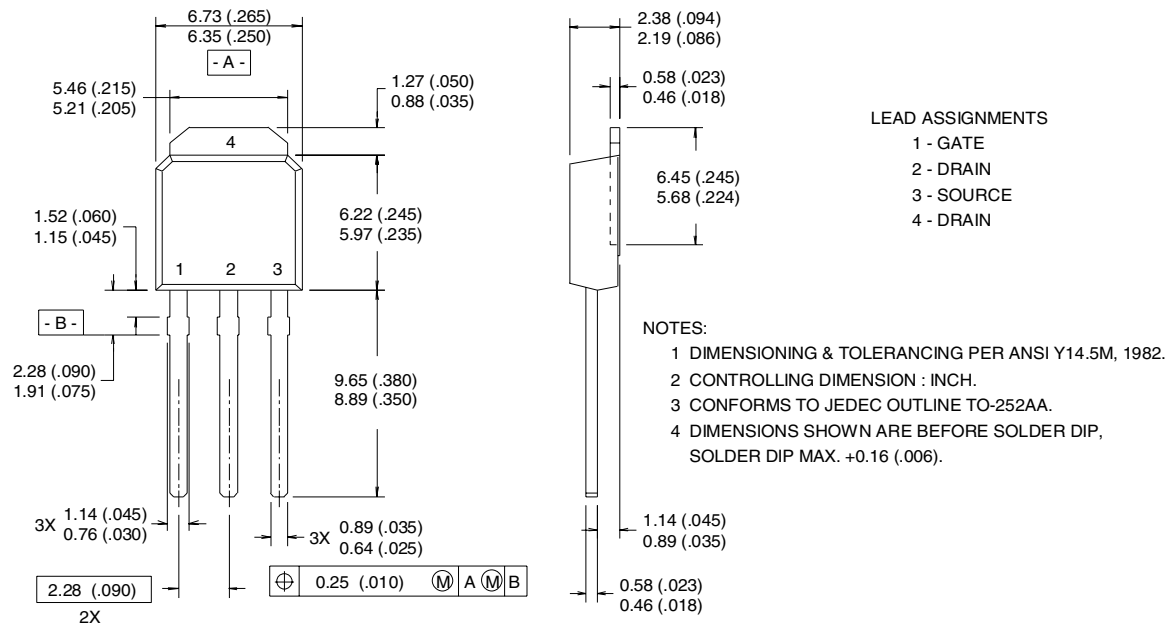

I-Pak (TO-251AA) Part Marking Information

EXAMPLE: THIS IS AN IRFU120
 LOT CODE 1789
 ASSEMBLED ON WW 19, 1997
 IN THE ASSEMBLY LINE "C"

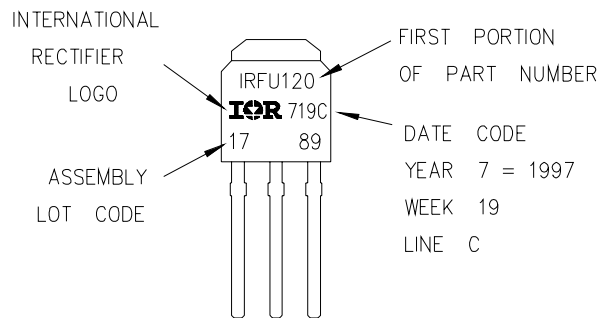

IRFR3518/IRFU3518

International
IR Rectifier

D-Pak (TO-252AA) Tape & Reel Information

Dimensions are shown in millimeters (inches)

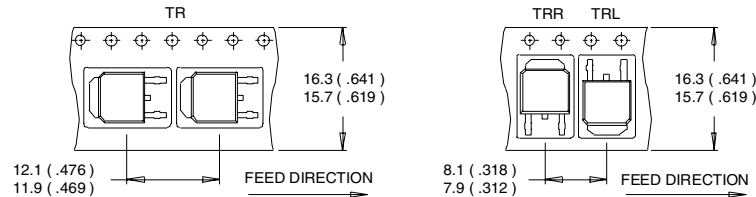

NOTES :

1. CONTROLLING DIMENSION : MILLIMETER.
2. ALL DIMENSIONS ARE SHOWN IN MILLIMETERS (INCHES).
3. OUTLINE CONFORMS TO EIA-481 & EIA-541.

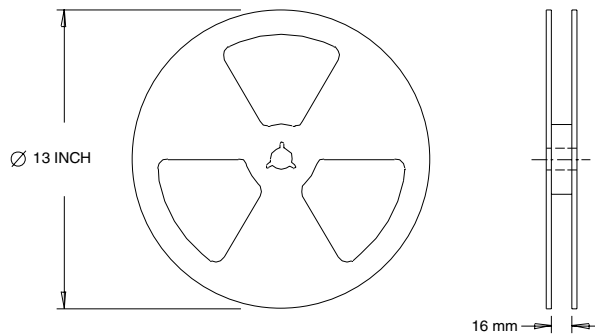

NOTES :

1. OUTLINE CONFORMS TO EIA-481.

Notes:

- ① Repetitive rating; pulse width limited by max. junction temperature.
- ② Starting $T_J = 25^\circ\text{C}$, $L = 0.99\text{mH}$
 $R_G = 25\Omega$, $I_{AS} = 18\text{A}$.
- ③ $I_{SD} \leq 18\text{A}$, $di/dt \leq 360\text{A}/\mu\text{s}$, $V_{DD} \leq V_{(BR)DSS}$,
 $T_J \leq 175^\circ\text{C}$.
- ④ Pulse width $\leq 300\mu\text{s}$; duty cycle $\leq 2\%$.
- ⑤ C_{OSS} eff. is a fixed capacitance that gives the same charging time as C_{OSS} while V_{DS} is rising from 0 to 80% V_{DSS} .
- ⑥ When mounted on 1" square PCB (FR-4 or G-10 Material).
For recommended footprint and soldering techniques refer to application note #AN-994.

Data and specifications subject to change without notice.
This product has been designed and qualified for the Industrial market.
Qualification Standards can be found on IR's Web site.

International
IR Rectifier

IR WORLD HEADQUARTERS: 233 Kansas St., El Segundo, California 90245, USA Tel: (310) 252-7105
TAC Fax: (310) 252-7903

Visit us at www.irf.com for sales contact information. 09/02

www.irf.com