

THYRISTOR MODULE

PK(PD,PE,KK)40F

UL:E76102(M)

Power Thyristor/Diode Module **PK40F** series are designed for various rectifier circuits and power controls. For your circuit application, following internal connections and wide voltage ratings up to 1,600V are available. High precision 25mm (1inch) width package and electrically isolated mounting base make your mechanical design easy.

- $I_{T(AV)}$ 40A, $I_{T(RMS)}$ 62A, I_{TSM} 1300A
- di/dt 150 A/ μ s
- dv/dt 500V/ μ s

(Applications)

Various rectifiers
AC/DC motor drives
Heater controls
Light dimmers
Static switches

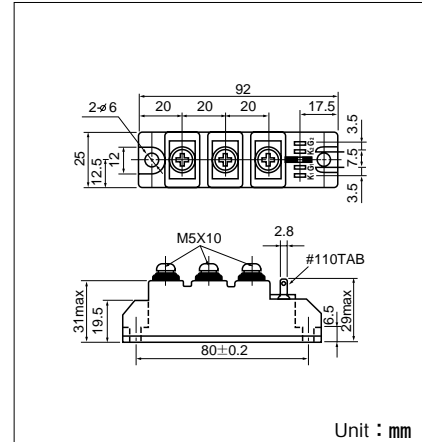
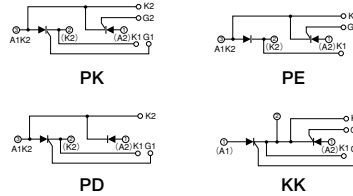

Maximum Ratings

Symbol	Item	Ratings				Unit
		PK40F40 PD40F40 PE40F40 KK40F40	PK40F80 PD40F80 PE40F80 KK40F80	PK40F120 PD40F120 PE40F120 KK40F120	PK40F160 PD40F160 PE40F160 KK40F160	
V_{RRM}	* Repetitive Peak Reverse Voltage	400	800	1200	1600	V
V_{RSM}	* Non-Repetitive Peak Reverse Voltage	480	960	1300	1700	V
V_{DRM}	Repetitive Peak Off-State Voltage	400	800	1200	1600	V

Symbol	Item	Conditions	Ratings	Unit	
$I_{T(AV)}$	* Average On-State Current	Single phase, half wave, 180° conduction, $T_c : 96^\circ\text{C}$	40	A	
$I_{T(RMS)}$	* R.M.S. On-State Current	Single phase, half wave, 180° conduction, $T_c : 96^\circ\text{C}$	62	A	
I_{TSM}	* Surge On-State Current	1/2 cycle, 50Hz/60Hz, peak Value, non-repetitive	1200/1300	A	
I^2t	* I^2t	Value for one cycle of surge current	7200	A ² S	
PGM	Peak Gate Power Dissipation		10	W	
$P_{G(AV)}$	Average Gate Power Dissipation		3	W	
I_{FGM}	Peak Gate Current		3	A	
V_{FGM}	Peak Gate Voltage (Forward)		10	V	
V_{RGM}	Peak Gate Voltage (Reverse)		5	V	
di/dt	Critical Rate of Rise of On-State Current	$I_G=100\text{mA}$, $T_j=25^\circ\text{C}$, $V_D=1/2V_{DRM}$, $dI_G/dt=0.1\text{A}/\mu\text{s}$	150	A/ μ s	
V_{iso}	* Isolation Breakdown Voltage (R.M.S.)	A.C. 1 minute	2500	V	
T_j	* Operating Junction Temperature		-40 to +125	°C	
T_{stg}	* Storage Temperature		-40 to +125	°C	
	Mounting Torque	Mounting (M5) Terminal (M5)	Recommended Value 1.5-2.5 (15-25) Recommended Value 1.5-2.5 (15-25)	2.7 (28) 2.7 (28)	N·m (kgf·cm)
	Mass		170	g	

Electrical Characteristics

Symbol	Item	Conditions	Ratings	Unit
I_{DRM}	Repetitive Peak Off-State Current, max.	at V_{DRM} , single phase, half wave, $T_j=125^\circ\text{C}$	15	mA
I_{RRM}	* Repetitive Peak Reverse Current, max.	at V_{DRM} , single phase, half wave, $T_j=125^\circ\text{C}$	15	mA
V_{TM}	* Peak On-State Voltage, max.	On-State Current 120A, $T_j=25^\circ\text{C}$ Inst. measurement	1.40	V
I_{GT}/V_{GT}	Gate Trigger Current/Voltage, max.	$T_j=25^\circ\text{C}$, $I_T=1\text{A}$, $V_D=6\text{V}$	70/3	mA/V
V_{GD}	Non-Trigger Gate, Voltage. min.	$T_j=125^\circ\text{C}$, $V_D=1/2V_{DRM}$	0.25	V
tgt	Turn On Time, max.	$I_T=40\text{A}$, $I_G=100\text{mA}$, $T_j=25^\circ\text{C}$, $V_D=1/2V_{DRM}$, $dI_G/dt=0.1\text{A}/\mu\text{s}$	10	μ s
dv/dt	Critical Rate of Rise of Off-State Voltage, min.	$T_j=125^\circ\text{C}$, $V_D=2/3V_{DRM}$, Exponential wave.	500	V/ μ s
I_H	Holding Current, typ.	$T_j=25^\circ\text{C}$	50	mA
I_L	Latching Current, typ.	$T_j=25^\circ\text{C}$	100	mA
$R_{th(j-c)}$	* Thermal Impedance, max.	Junction to case	0.55	°C/W

* mark : Thyristor and Diode part. No mark : Thyristor part

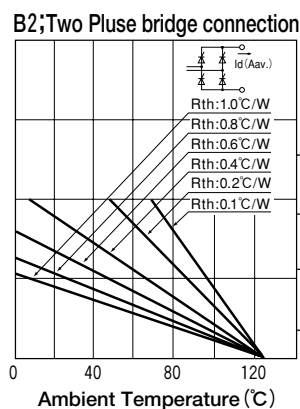
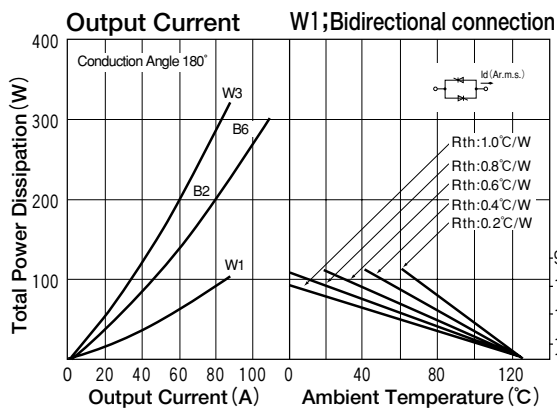
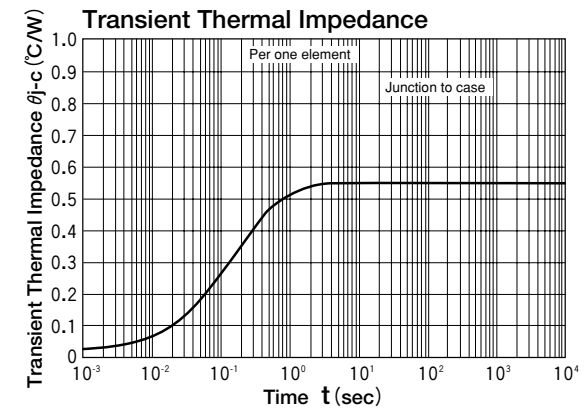
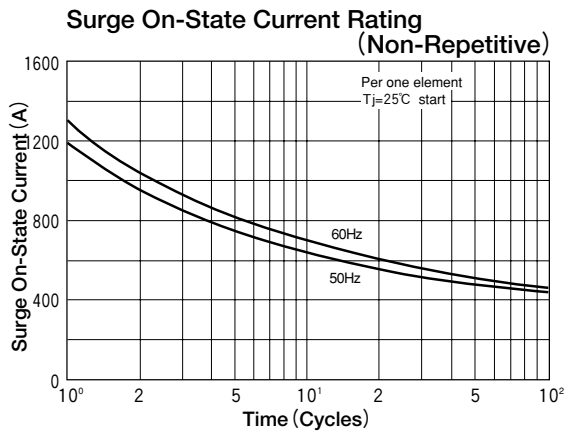
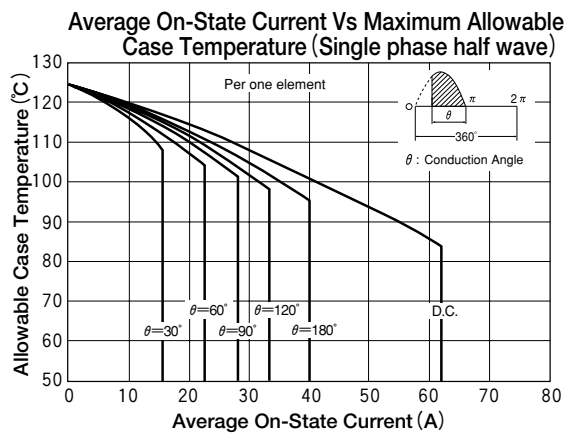
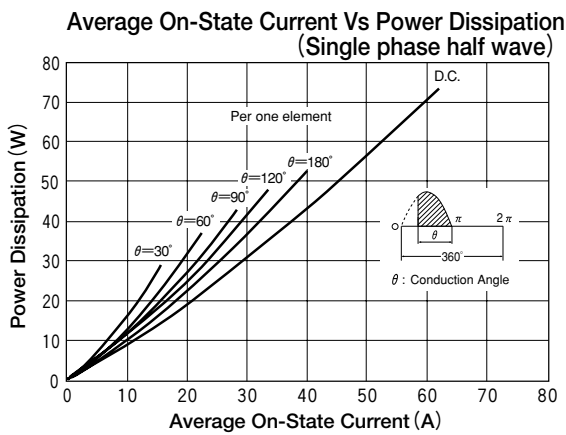
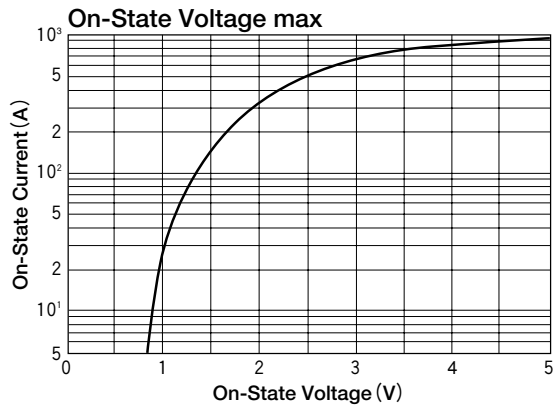
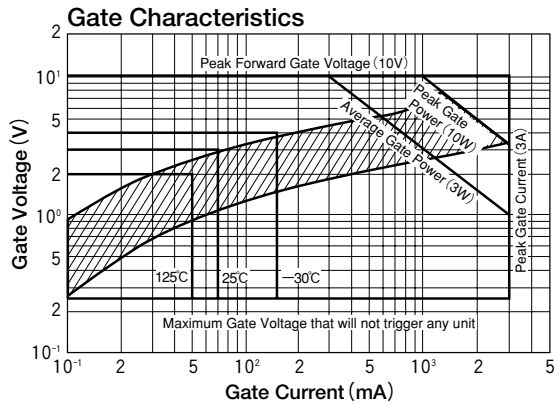

B6; Six pulse bridge connection
W3; Three phase
bidirectional connection

