



BC817

NPN EPITAXIAL SILICON TRANSISTOR

NPN GENERAL PURPOSE AMPLIFIER

■ Description

The UTC **BC817** is designed for general purpose medium power amplifiers and switches requiring collector currents to 1.2A.

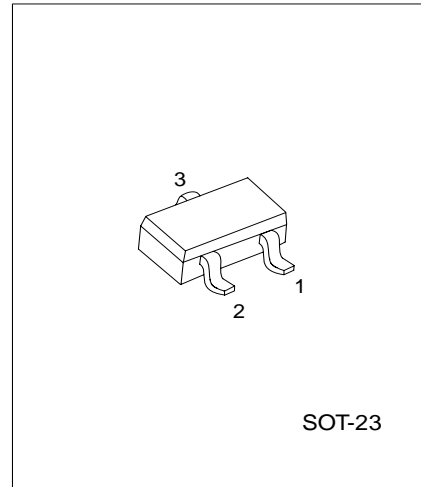

SOT-23

*Pb-free plating product number:BC817L

■ PIN CONFIGURATION

PIN NO.	PIN NAME
1	EMITTER
2	BASE
3	COLLECTOR

■ ORDERING INFORMATION

Order Number		Package	Packing
Normal	Lead Free Plating		
BC817-16-AE3-R	BC817L-16-AE3-R	SOT-23	Tape & Reel
BC817-25-AE3-R	BC817L-25-AE3-R	SOT-23	Tape & Reel
BC817-40-AE3-R	BC817L-40-AE3-R	SOT-23	Tape & Reel

■ MARKING

BC817-16	BC817-25	BC817-40

BC817

NPN EPITAXIAL SILICON TRANSISTOR

■ ABSOLUTE MAXIMUM RATING(Ta=25°C, unless otherwise specified)

PARAMETER	SYMBOL	RATINGS	UNIT
Collector-Emitter Voltage	V _{CEO}	45	V
Collector-Base Voltage	V _{CES}	50	V
Emitter-Base Voltage	V _{EBO}	5.0	V
Collector Current -Continuous	I _C	1.5	A
Power Dissipation Derate above 25°C	P _D	350 2.8	mW mW/°C
Junction Temperature	T _J	150	
Storage Temperature	T _{STG}	-40 ~ +150	

Note 1. Absolute maximum ratings are those values beyond which the device could be permanently damaged.

Absolute maximum ratings are stress ratings only and functional device operation is not implied.

2. The device is guaranteed to meet performance specification within 0 ~+70 operating temperature range and assured by design from -20 ~+85 .

■ THERMAL CHARACTERISTICS (Ta=25°C, unless otherwise specified)

CHARACTERISTIC	SYMBOL	RATING (Note)	UNIT
Thermal Resistance, Junction to Ambient	θ _{JA}	350	°C/W

Note: Device mounted on FR-4 PCB 40mmx40mmx1.5mm.

■ ELECTRICAL CHARACTERISTICS (Ta=25°C, unless otherwise specified)

PARAMETER	SYMBOL	TEST CONDITIONS	MIN	TYP	MAX	UNIT
OFF CHARACTERISTICS						
Collector-Emitter Breakdown Voltage	V _{(BR)CEO}	I _C =10mA, I _B =0	45			V
Collector-Base Breakdown Voltage	V _{(BR)CES}	I _C =100μA, I _E =0	50			V
Emitter-Base Breakdown Voltage	V _{(BR)EBO}	I _E =10μA, I _C =0	5			V
Collector-Cutoff Current	I _{CBO}	V _{CB} =20V V _{CB} =20V, T _a =150°C			100 5	nA μA
ON CHARACTERISTICS						
DC Current Gain	h _{FE1} *	I _C =100mA, V _{CE} =1.0V	See Classification			
	h _{FE2}	I _C =500mA, V _{CE} =1.0V	40			
Collector-Emitter Saturation Voltage	V _{CE(SAT)}	I _C =500mA, I _B =50Ma			0.7	V
Base-Emitter On Voltage	V _{BE(ON)}	I _C =500mA, V _{CE} =1.0V			1.2	V

■ CLASSIFICATION OF hFE1*

RANK	BC817-16	BC817-25	BC817-40
RANGE	100-250	160-400	250-600

TYPICAL CHARACTERISTICS

Typical Pulsed Current Gain vs Collector Current

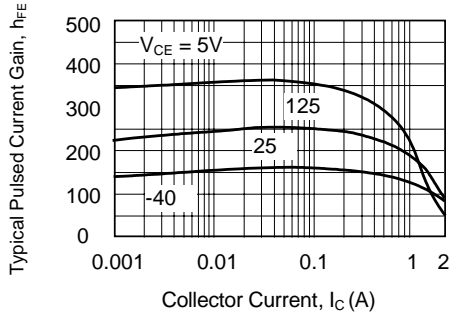

Collector-Emitter Saturation Voltage vs Collector Current

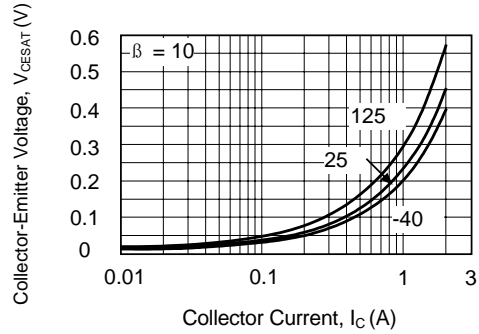

Base-Emitter Saturation Voltage vs Collector Current

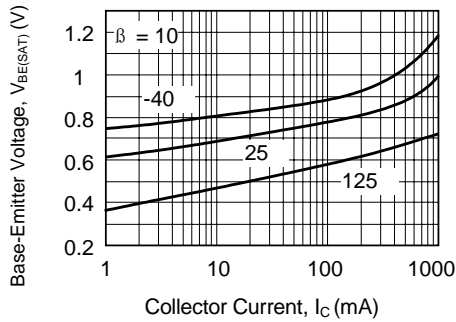

Base-Emitter On Voltage vs Collector Current

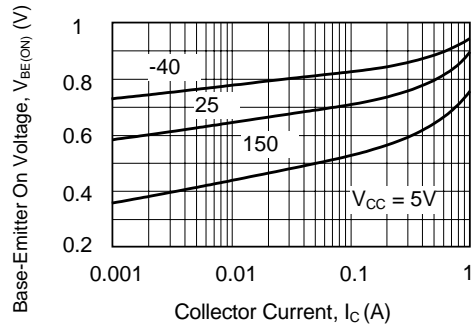

Collector-Cutoff Current vs Ambient Temperature

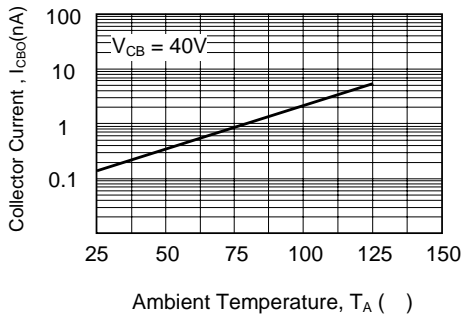

Collector-Base Capacitance vs Collector-Base Voltage

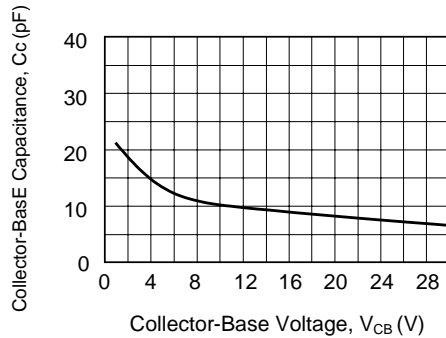

■ TYPICAL CHARACTERISTICS(cont.)

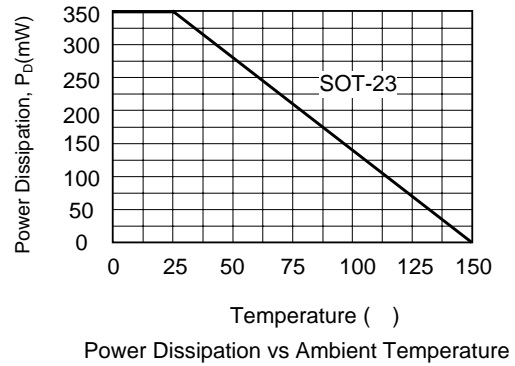
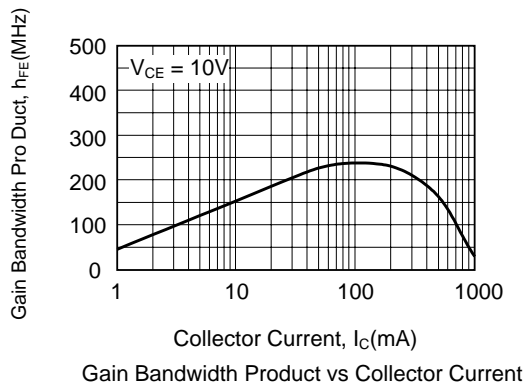

UTC assumes no responsibility for equipment failures that result from using products at values that exceed, even momentarily, rated values (such as maximum ratings, operating condition ranges, or other parameters) listed in products specifications of any and all UTC products described or contained herein. UTC products are not designed for use in life support appliances, devices or systems where malfunction of these products can be reasonably expected to result in personal injury. Reproduction in whole or in part is prohibited without the prior written consent of the copyright owner. The information presented in this document does not form part of any quotation or contract, is believed to be accurate and reliable and may be changed without notice.