



# Aluminum electrolytic capacitors

## Snap-in capacitors

**Series/Type:** B43508  
**Date:** December 2006

© EPCOS AG 2007. Reproduction, publication and dissemination of this publication, enclosures hereto and the information contained therein without EPCOS' prior express consent is prohibited.

## Long-life grade capacitors

### Applications

- Frequency converters
- Professional power supplies in industrial electronics and in data processing equipment
- Switch-mode power supplies in entertainment electronics

### Features

- Extremely high CV product, ultra compact
- High reliability
- High ripple current capability
- Different case sizes available for each capacitance value

### Construction

- Charge/discharge-proof, polar
- Aluminum case, fully insulated
- Snap-in solder pins to hold component in place on PC-board
- Minus pole marking on case surface
- Minus pole not insulated from case
- Overload protection by safety vent on the base

### Terminals

- Standard version with 2 terminals,  
2 lengths available: 6.3 and 4.5 mm
- 3 terminals to ensure correct insertion: length 4.5 mm

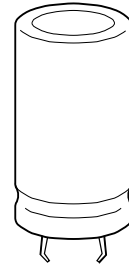

**Specifications and characteristics in brief**

Rated voltage $V_R$ Surge voltage $V_S$	200 ... 450 V DC $1.15 \cdot V_R$ (for $V_R \leq 250$ V DC) $1.10 \cdot V_R$ (for $V_R \geq 400$ V DC)	
Rated capacitance $C_R$ Capacitance tolerance	82 ... 2700 $\mu$ F $\pm 20\% \triangleq M$	
Dissipation factor $\tan \delta$ (20 °C, 120 Hz)	$V_R \leq 250$ V DC: $\tan \delta \leq 0.15$ $V_R \geq 400$ V DC: $\tan \delta \leq 0.20$	
Leakage current $I_{leak}$ (5 min, 20 °C)	$I_{leak} \leq 0.3 \mu A \cdot \left( \frac{C_R}{\mu F} \cdot \frac{V_R}{V} \right)^{0.7} + 4 \mu A$	
Self-inductance ESL	Approx. 20 nH	
Useful life 105 °C, $V_R$ , $I_{AC,R}$ 85 °C, $V_R$ , $I_{AC,max}$ 40 °C, $V_R$ , $1.9 \cdot I_{AC,R}$	> 3000 h > 6500 h > 200000 h	Requirements: $\Delta C/C \leq \pm 30\%$ of initial value $\tan \delta \leq 3$ times initial specified limit $I_{leak} \leq$ initial specified limit
Load life test 105 °C, $V_R$ , $I_{AC,R}$	2000 h	Post test requirements $\Delta C/C \leq \pm 20\%$ of initial value $\tan \delta \leq 2$ times initial specified limit $I_{leak} \leq$ initial specified limit
Voltage endurance test 85 °C, $V_R$	2000 h	Post test requirements: $\Delta C/C \leq \pm 10\%$ of initial value $\tan \delta \leq 1.3$ times initial specified limit $I_{leak} \leq$ initial specified limit
Vibration resistance test	To IEC 60068-2-6, test Fc: Displacement amplitude 0.35 mm, frequency range 10 Hz ... 55 Hz, acceleration max. 5 g, duration $3 \times 2$ h. Capacitor mounted by its body which is rigidly clamped to the work surface.	
IEC climatic category	To IEC 60068-1: $V_R \leq 250$ V DC: 40/105/56 (–40 °C/+105 °C/56 days damp heat test) $V_R \geq 400$ V DC: 25/105/56 (–25 °C/+105 °C/56 days damp heat test)	
Detail specification Sectional specification	Similar to CECC 30301-809 IEC 60384-4	

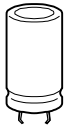

**B43508**

**Ultra compact – 105 °C**

**Dimensional drawings**

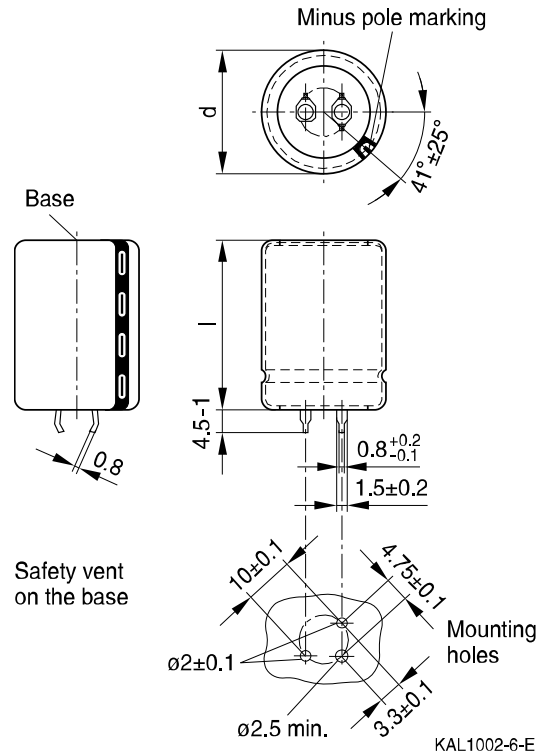
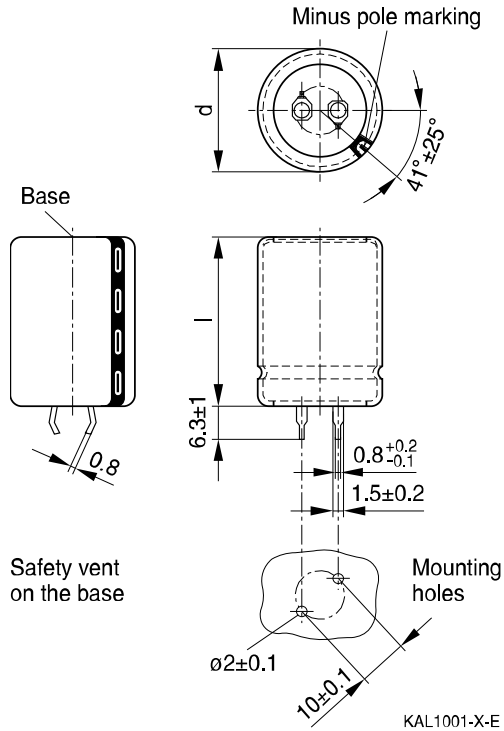

Snap-in terminals, length  $6.3 \pm 1$  mm.  
Also available in a shorter version with a length of  $4.5 - 1$  mm. For packing mode and ordering example see next page.

Snap-in capacitors are also available with 3 terminals (length  $4.5 - 1$  mm).  
For packing mode and ordering example see next page.

Dimensions (mm)		Approx weight(g)	Packing units (pcs.)
d +1	l ±2		
22	25	9	160
22	30	12	160
22	35	15	160
22	40	18	160
22	45	20	160
22	50	24	160
<hr/>			
25	25	13	130
25	30	17	130
25	35	19	130
25	40	22	130
25	45	25	130
25	50	29	130
25	55	32	130

Dimensions (mm)		Approx weight(g)	Packing units (pcs.)
d +1	l ±2		
30	25	17	80
30	30	23	80
30	35	29	80
30	40	36	80
30	45	41	80
30	50	46	80
30	55	53	80
<hr/>			
35	25	22	60
35	30	29	60
35	35	36	60
35	40	41	60
35	45	56	60
35	50	70	60
35	55	81	60

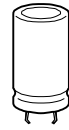

### Packing of snap-in capacitors



For ecological reasons the packing is pure cardboard. Components can be withdrawn (in full or in part) in the correct position for insertion.

### Ordering codes for terminal styles

Snap-in capacitors	Identification in 3rd block of ordering code
Terminal versions	
Standard terminals (6.3 ±1) mm	M000
Short terminals (4.5 –1) mm	M007
3 terminals (4.5 –1) mm	M002

Ordering examples:

B43508A5107M007 } snap-in capacitor with short terminals  
 B43508A5107M002 } snap-in capacitor with 3 terminals

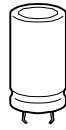

**B43508**
**Ultra compact – 105 °C**
**Overview of available types**

$V_R$ (V DC)	200	250	400	450
	Case dimensions $d \times l$ (mm)			
$C_R$ ( $\mu\text{F}$ )				
82				22 × 25
100			22 × 25	22 × 30 25 × 25
120			22 × 30	22 × 35 25 × 30
150			22 × 30 25 × 25	22 × 40 25 × 30 30 × 25
180			22 × 35 25 × 30	22 × 45 25 × 35 30 × 30
220		22 × 25	22 × 40 25 × 35 30 × 25	22 × 50 25 × 40 30 × 30 35 × 25
270		22 × 30	22 × 50 25 × 40 30 × 30	25 × 50 30 × 35 35 × 30
330	22 × 25	22 × 30 25 × 25	25 × 45 30 × 35 35 × 25	25 × 55 30 × 40 35 × 35
390	22 × 30 25 × 25	22 × 35 25 × 30	25 × 50 30 × 35 35 × 30	30 × 45 35 × 35
470	22 × 35 25 × 30	22 × 40 25 × 30 30 × 25	30 × 40 35 × 35	30 × 55 35 × 40
560	22 × 35 25 × 30	22 × 45 25 × 35 30 × 30	30 × 50 35 × 40	35 × 45
680	22 × 40 25 × 35 30 × 25	22 × 50 25 × 40 30 × 30 35 × 25	30 × 55 35 × 45	35 × 55

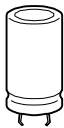

$V_R$ (V DC)	200	250	400	450
	Case dimensions $d \times l$ (mm)			
$C_R$ ( $\mu$ F)				
820	22 × 50 25 × 40 30 × 30 35 × 25	25 × 45 30 × 35 35 × 30	35 × 50	
1000	25 × 45 30 × 35 35 × 30	25 × 55 30 × 40 35 × 30	35 × 55	
1200	25 × 50 30 × 40 35 × 30	30 × 45 35 × 35		
1500	30 × 45 35 × 35	30 × 55 35 × 40		
1800	30 × 50 35 × 40	35 × 50		
2200	35 × 45	35 × 55		
2700	35 × 55			

The capacitance and voltage ratings listed above are available in different cases upon request. Other voltage and capacitance ratings are also available upon request.

**B43508**
**Ultra compact – 105 °C**
**Technical data and ordering codes**

$C_R$ 100 Hz 20 °C $\mu\text{F}$	Case dimensions $d \times l$ mm	$\text{ESR}_{\text{typ}}$ 100 Hz 20 °C m $\Omega$	$Z_{\text{max}}$ 10 kHz 20 °C m $\Omega$	$I_{\text{AC,max}}$ 100 Hz 60 °C A	$I_{\text{AC,max}}$ 100 Hz 85 °C A	$I_{\text{AC,R}}^{1)}$ 100 Hz 105 °C A	Ordering code (composition see below)
<b><math>V_R = 200 \text{ V DC}</math></b>							
330	22 × 25	350	480	2.85	2.13	1.05	B43508A2337M00*
390	22 × 30	300	400	3.23	2.42	1.19	B43508A2397M00*
390	25 × 25	300	400	3.19	2.39	1.18	B43508B2397M00*
470	22 × 35	250	340	3.68	2.75	1.36	B43508A2477M00*
470	25 × 30	250	340	3.65	2.73	1.35	B43508B2477M00*
560	22 × 35	210	280	4.02	3.00	1.48	B43508A2567M00*
560	25 × 30	210	280	3.99	2.98	1.47	B43508B2567M00*
680	22 × 40	170	230	4.56	3.41	1.69	B43508A2687M00*
680	25 × 35	170	230	4.55	3.40	1.68	B43508B2687M00*
680	30 × 25	170	230	4.02	3.00	1.48	B43508C2687M00*
820	22 × 50	140	200	5.28	3.95	1.95	B43508A2827M00*
820	25 × 40	140	200	5.16	3.86	1.91	B43508B2827M00*
820	30 × 30	140	200	4.60	3.44	1.70	B43508C2827M00*
820	35 × 25	140	200	3.91	2.92	1.44	B43508D2827M00*
1000	25 × 45	120	160	5.85	4.38	2.16	B43508A2108M00*
1000	30 × 35	120	160	5.26	3.93	1.95	B43508B2108M00*
1000	35 × 30	120	160	4.79	3.58	1.77	B43508C2108M00*
1200	25 × 50	100	130	6.57	4.92	2.43	B43508A2128M00*
1200	30 × 40	100	130	6.33	4.74	2.34	B43508B2128M00*
1200	35 × 30	100	130	5.24	3.92	1.94	B43508C2128M00*
1500	30 × 45	75	110	7.28	5.44	2.69	B43508A2158M00*
1500	35 × 35	75	110	6.07	4.54	2.25	B43508B2158M00*
1800	30 × 50	65	90	8.18	6.12	3.02	B43508A2188M00*
1800	35 × 40	65	90	6.86	5.13	2.54	B43508B2188M00*
2200	35 × 45	55	75	7.80	5.84	2.89	B43508A2228M00*
2700	35 × 55	45	60	9.07	6.78	3.36	B43508A2278M00*
<b><math>V_R = 250 \text{ V DC}</math></b>							
220	22 × 25	530	710	2.48	1.85	0.91	B43508E2227M00*
270	22 × 30	430	580	2.86	2.14	1.06	B43508E2277M00*
330	22 × 30	350	480	3.16	2.37	1.17	B43508E2337M00*
330	25 × 25	350	480	3.11	2.32	1.15	B43508F2337M00*
390	22 × 35	300	400	3.56	2.66	1.32	B43508E2397M00*
390	25 × 30	300	400	3.52	2.63	1.30	B43508F2397M00*

**Composition of ordering code**

\* = Terminal style

0 = snap-in standard terminals (6.3 ±1) mm

2 = snap-in 3 terminals (4.5 – 1) mm

7 = snap-in short terminals (4.5 – 1) mm

 1) 120-Hz conversion factor of ripple current:  $I_{\text{AC}}(120 \text{ Hz}) = 1.03 \cdot I_{\text{AC}}(100 \text{ Hz})$



**Technical data and ordering codes**

$C_R$ 100 Hz 20 °C $\mu\text{F}$	Case dimensions $d \times l$ mm	$\text{ESR}_{\text{typ}}$ 100 Hz 20 °C m $\Omega$	$Z_{\text{max}}$ 10 kHz 20 °C m $\Omega$	$I_{\text{AC,max}}$ 100 Hz 60 °C A	$I_{\text{AC,max}}$ 100 Hz 85 °C A	$I_{\text{AC,R}^2)$ 100 Hz 105 °C A	Ordering code (composition see below)
<b><math>V_R = 250 \text{ V DC}</math></b>							
470	22 × 40	250	340	4.03	3.02	1.49	B43508E2477M00*
470	25 × 30	250	340	3.86	2.89	1.43	B43508F2477M00*
470	30 × 25	250	340	3.48	2.60	1.29	B43508G2477M00*
560	22 × 45	210	280	4.52	3.38	1.67	B43508E2567M00*
560	25 × 35	210	280	4.37	3.27	1.62	B43508F2567M00*
560	30 × 30	210	280	3.96	2.96	1.46	B43508G2567M00*
680	22 × 50	170	230	5.11	3.82	1.89	B43508E2687M00*
680	25 × 40	170	230	4.97	3.72	1.84	B43508F2687M00*
680	30 × 30	170	230	4.37	3.27	1.61	B43508G2687M00*
680	35 × 25	170	230	3.66	2.74	1.35	B43508H2687M00*
820	25 × 45	140	200	5.61	4.20	2.07	B43508E2827M00*
820	30 × 35	140	200	4.97	3.72	1.84	B43508F2827M00*
820	35 × 30	140	200	4.46	3.33	1.65	B43508G2827M00*
1000	25 × 55	120	160	6.49	4.86	2.40	B43508E2108M00*
1000	30 × 40	120	160	6.03	4.51	2.23	B43508F2108M00*
1000	35 × 30	120	160	4.92	3.68	1.82	B43508G2108M00*
1200	30 × 45	100	130	6.79	5.08	2.51	B43508E2128M00*
1200	35 × 35	100	130	5.59	4.18	2.07	B43508F2128M00*
1500	30 × 55	75	110	7.96	5.96	2.95	B43508E2158M00*
1500	35 × 40	75	110	6.44	4.82	2.38	B43508F2158M00*
1800	35 × 50	65	90	7.44	5.57	2.75	B43508E2188M00*
2200	35 × 55	55	75	8.42	6.30	3.12	B43508E2228M00*
<b><math>V_R = 400 \text{ V DC}</math></b>							
100	22 × 25	1230	1730	1.63	1.22	0.60	B43508A9107M00*
120	22 × 30	1020	1440	1.87	1.39	0.69	B43508A9127M00*
150	22 × 30	820	1150	2.09	1.56	0.77	B43508A9157M00*
150	25 × 25	820	1150	2.09	1.56	0.77	B43508B9157M00*
180	22 × 35	680	960	2.37	1.77	0.87	B43508A9187M00*
180	25 × 30	680	960	2.39	1.79	0.88	B43508B9187M00*
220	22 × 40	560	790	2.70	2.02	1.00	B43508A9227M00*
220	25 × 35	560	790	2.74	2.05	1.01	B43508B9227M00*
220	30 × 25	560	790	2.65	1.98	0.98	B43508C9227M00*
270	22 × 50	460	640	3.15	2.35	1.16	B43508A9277M00*

**Composition of ordering code**

\* = Terminal style

0 = snap-in standard terminals (6.3 ±1) mm

2 = snap-in 3 terminals (4.5 – 1) mm

7 = snap-in short terminals (4.5 – 1) mm

2) 120-Hz conversion factor of ripple current:  $I_{\text{AC}}(120 \text{ Hz}) = 1.03 \cdot I_{\text{AC}}(100 \text{ Hz})$

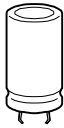
**B43508**
**Ultra compact – 105 °C**
**Technical data and ordering codes**

$C_R$ 100 Hz 20 °C $\mu\text{F}$	Case dimensions $d \times l$ mm	$\text{ESR}_{\text{typ}}$ 100 Hz 20 °C m $\Omega$	$Z_{\text{max}}$ 10 kHz 20 °C m $\Omega$	$I_{\text{AC,max}}$ 100 Hz 60 °C A	$I_{\text{AC,max}}$ 100 Hz 85 °C A	$I_{\text{AC,R}}^{3)}$ 100 Hz 105 °C A	Ordering code (composition see below)
<b><math>V_R = 400 \text{ V DC}</math></b>							
270	25 × 40	460	640	3.13	2.34	1.16	B43508B9277M00*
270	30 × 30	460	640	3.06	2.29	1.13	B43508C9277M00*
330	25 × 45	370	530	3.56	2.66	1.31	B43508A9337M00*
330	30 × 35	370	530	3.50	2.62	1.29	B43508B9337M00*
330	35 × 25	370	530	3.20	2.39	1.18	B43508C9337M00*
390	25 × 50	320	450	3.96	2.96	1.46	B43508A9397M00*
390	30 × 35	320	450	3.81	2.85	1.41	B43508B9397M00*
390	35 × 30	320	450	3.86	2.88	1.43	B43508C9397M00*
470	30 × 40	260	370	4.59	3.44	1.70	B43508A9477M00*
470	35 × 35	260	370	4.39	3.28	1.62	B43508B9477M00*
560	30 × 50	220	310	5.29	3.95	1.96	B43508A9567M00*
560	35 × 40	220	310	4.94	3.70	1.83	B43508B9567M00*
680	30 × 55	180	260	5.96	4.46	2.20	B43508A9687M00*
680	35 × 45	180	260	5.60	4.19	2.07	B43508B9687M00*
820	35 × 50	150	210	6.31	4.72	2.33	B43508A9827M00*
1000	35 × 55	120	180	7.13	5.33	2.64	B43508A9108M00*
<b><math>V_R = 450 \text{ V DC}</math></b>							
82	22 × 25	1500	2100	1.58	1.18	0.58	B43508A5826M00*
100	22 × 30	1230	1730	1.82	1.36	0.67	B43508A5107M00*
100	25 × 25	1230	1730	1.82	1.36	0.67	B43508B5107M00*
120	22 × 35	1020	1440	2.07	1.54	0.76	B43508A5127M00*
120	25 × 30	1020	1440	2.08	1.55	0.77	B43508B5127M00*
150	22 × 40	820	1150	2.38	1.78	0.88	B43508A5157M00*
150	25 × 30	820	1150	2.33	1.74	0.86	B43508B5157M00*
150	30 × 25	820	1150	2.39	1.79	0.88	B43508C5157M00*
180	22 × 45	680	960	2.68	2.01	0.99	B43508A5187M00*
180	25 × 35	680	960	2.64	1.97	0.97	B43508B5187M00*
180	30 × 30	680	960	2.73	2.04	1.01	B43508C5187M00*
220	22 × 50	560	790	3.04	2.27	1.12	B43508A5227M00*
220	25 × 40	560	790	3.01	2.25	1.11	B43508B5227M00*
220	30 × 30	560	790	3.02	2.26	1.11	B43508C5227M00*
220	35 × 25	560	790	2.89	2.16	1.07	B43508D5227M00*
270	25 × 50	460	640	3.51	2.63	1.30	B43508A5277M00*

**Composition of ordering code**

\* = Terminal style

0 = snap-in standard terminals (6.3 ±1) mm

2 = snap-in 3 terminals (4.5 – 1) mm

7 = snap-in short terminals (4.5 – 1) mm

 3) 120-Hz conversion factor of ripple current:  $I_{\text{AC}}(120 \text{ Hz}) = 1.03 \cdot I_{\text{AC}}(100 \text{ Hz})$

**Technical data and ordering codes**

$C_R$ 100 Hz 20 °C μF	Case dimensions d × l mm	$ESR_{typ}$ 100 Hz 20 °C mΩ	$Z_{max}$ 10 kHz 20 °C mΩ	$I_{AC,max}$ 100 Hz 60 °C A	$I_{AC,max}$ 100 Hz 85 °C A	$I_{AC,R}^{4)}$ 100 Hz 105 °C A	Ordering code (composition see below)
<b><math>V_R = 450</math> V DC</b>							
270	30 × 35	460	640	3.47	2.59	1.28	B43508B5277M00*
270	35 × 30	460	640	3.55	2.65	1.31	B43508C5277M00*
330	25 × 55	370	530	3.97	2.97	1.47	B43508A5337M00*
330	30 × 40	370	530	4.21	3.15	1.56	B43508B5337M00*
330	35 × 35	370	530	4.06	3.04	1.50	B43508C5337M00*
390	30 × 45	320	450	4.71	3.52	1.74	B43508A5397M00*
390	35 × 35	320	450	4.42	3.30	1.63	B43508B5397M00*
470	30 × 55	260	370	5.42	4.05	2.00	B43508A5477M00*
470	35 × 40	260	370	5.00	3.74	1.85	B43508B5477M00*
560	35 × 45	220	310	5.62	4.20	2.08	B43508A5567M00*
680	35 × 55	180	260	6.50	4.86	2.40	B43508A5687M00*

**Composition of ordering code**

\* = Terminal style

0 = snap-in standard terminals (6.3 ±1) mm

2 = snap-in 3 terminals (4.5 – 1) mm

7 = snap-in short terminals (4.5 – 1) mm

4) 120-Hz conversion factor of ripple current:  $I_{AC}(120\text{ Hz}) = 1.03 \cdot I_{AC}(100\text{ Hz})$

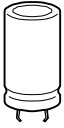

**B43508**

**Ultra compact – 105 °C**

**Useful life**

depending on ambient temperature  $T_A$  under ripple current operating conditions<sup>1)</sup>

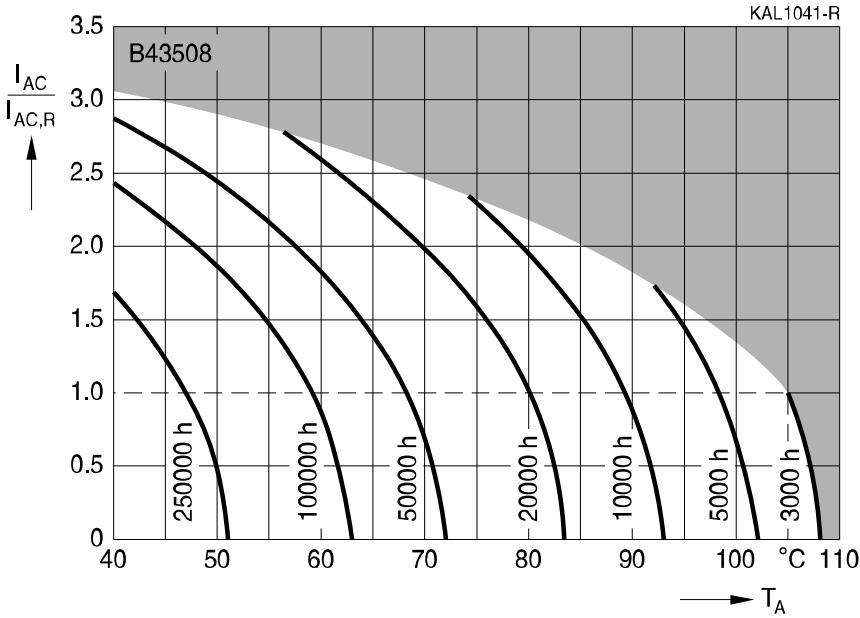

**Frequency factor of permissible ripple current  $I_{AC}$  versus frequency  $f$**

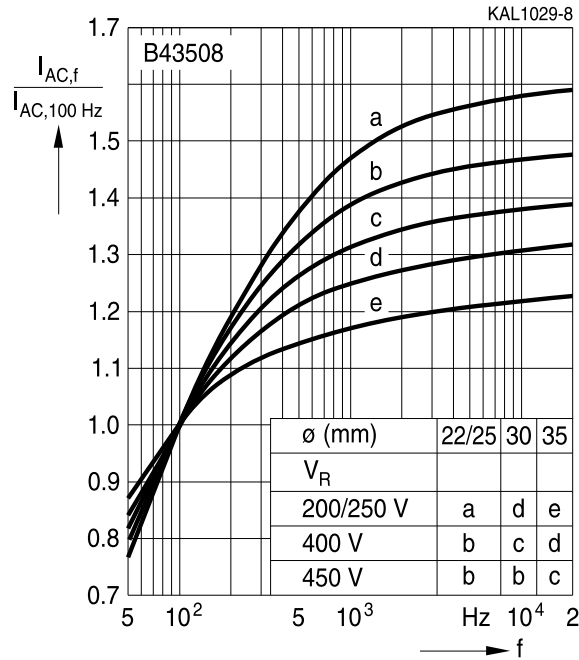

**Frequency characteristics of ESR**  
Typical behavior

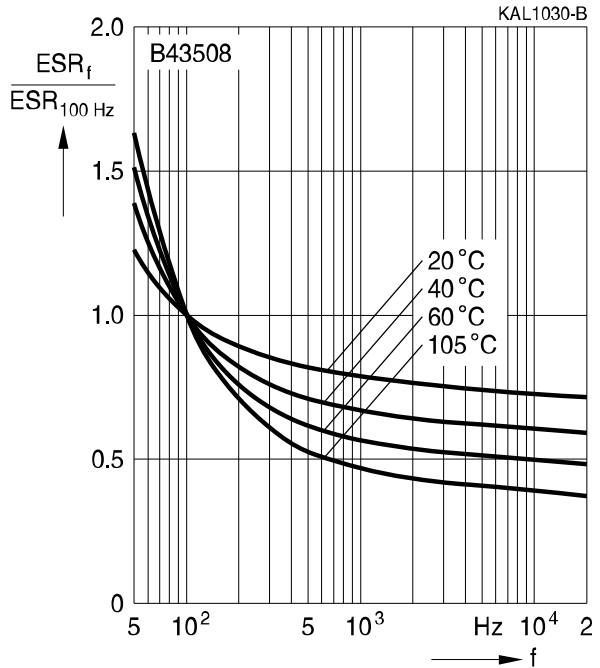

1) Refer to chapter "General technical information, 5.3 Calculation of useful life" for an explanation on how to interpret the useful life graphs.

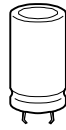

**Impedance Z versus frequency f**  
 Typical behavior at 20 °C

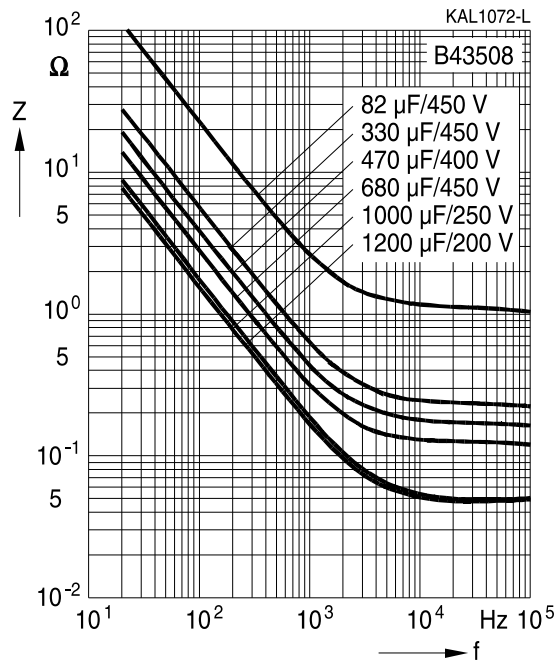

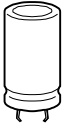

**B43508**

**Ultra compact – 105 °C**

## Cautions and warnings

### Personal safety

The electrolytes used by EPCOS have not only been optimized with a view to the intended application, but also with regard to health and environmental compatibility. They do not contain any solvents that are detrimental to health, e.g. dimethyl formamide (DMF) or dimethyl acetamide (DMAC).

Furthermore, part of the high-voltage electrolytes used by EPCOS are self-extinguishing. They contain flame-retarding substances which will quickly extinguish any flame that may have been ignited.

As far as possible, EPCOS does not use any dangerous chemicals or compounds to produce operating electrolytes. However, in exceptional cases, such materials must be used in order to achieve specific physical and electrical properties because no safe substitute materials are currently known. However, the amount of dangerous materials used in our products has been limited to an absolute minimum. Nevertheless, the following rules should be observed when handling Al electrolytic capacitors:

- Any escaping electrolyte should not come into contact with eyes or skin.
- If electrolyte does come into contact with the skin, wash the affected parts immediately with running water. If the eyes are affected, rinse them for 10 minutes with plenty of water. If symptoms persist, seek medical treatment.
- Avoid breathing in electrolyte vapor or mists. Workplaces and other affected areas should be well ventilated. Clothing that has been contaminated by electrolyte must be changed and rinsed in water.



## Product safety

The table below summarizes the safety instructions that must be observed without fail. A detailed description can be found in the relevant sections of chapter "General technical information".

Topic	Safety information	Reference Chapter "General technical information"
Polarity	Make sure that polar capacitors are connected with the right polarity.	1 "Basic construction of aluminum electrolytic capacitors"
Reverse voltage	Voltages polarity classes should be prevented by connecting a diode.	3.1.6 "Reverse voltage"
Upper category temperature	Do not exceed the upper category temperature.	7.2 "Maximum permissible operating temperature"
Maintenance	Make periodic inspections of the capacitors. Before the inspection, make sure that the power supply is turned off and carefully discharge the electricity of the capacitors. Do not apply any mechanical stress to the capacitor terminals.	10 "Maintenance"
Mounting position of screw terminal capacitors	Do not mount the capacitor with the terminals (safety vent) upside down.	11.1. "Mounting positions of capacitors with screw terminals"
Mounting of single-ended capacitors	The internal structure of single-ended capacitors might be damaged if excessive force is applied to the lead wires. Avoid any compressive, tensile or flexural stress. Do not move the capacitor after soldering to PC board. Do not pick up the PC board by the soldered capacitor. Do not insert the capacitor on the PC board with a hole space different to the lead space specified.	11.4 "Mounting considerations for single-ended capacitors"
Robustness of terminals	The following maximum tightening torques must not be exceeded when connecting screw terminals: M5: 2 Nm M6: 2.5 Nm	11.3 "Mounting torques"
Soldering	Do not exceed the specified time or temperature limits during soldering.	11.5 "Soldering"

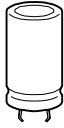

**B43508**

**Ultra compact – 105 °C**

Topic	Safety information	Reference Chapter "General technical information"
Soldering, cleaning agents	Do not allow halogenated hydrocarbons to come into contact with aluminum electrolytic capacitors.	11.6 "Cleaning agents"
Passive flammability	Avoid external energy, such as fire or electricity.	8.1 "Passive flammability"
Active flammability	Avoid overload of the capacitors.	8.2 "Active flammability"
		Reference Chapter "Capacitors with screw terminals"
Breakdown strength of insulating sleeves	Do not damage the insulating sleeve, especially when ring clips are used for mounting.	"Screw terminals - accessories"



## Important notes

The following applies to all products named in this publication:

1. Some parts of this publication contain **statements about the suitability of our products for certain areas of application**. These statements are based on our knowledge of typical requirements that are often placed on our products in the areas of application concerned. We nevertheless expressly point out **that such statements cannot be regarded as binding statements about the suitability of our products for a particular customer application**. As a rule, EPCOS is either unfamiliar with individual customer applications or less familiar with them than the customers themselves. For these reasons, it is always ultimately incumbent on the customer to check and decide whether an EPCOS product with the properties described in the product specification is suitable for use in a particular customer application.
2. We also point out that **in individual cases, a malfunction of passive electronic components or failure before the end of their usual service life cannot be completely ruled out in the current state of the art, even if they are operated as specified**. In customer applications requiring a very high level of operational safety and especially in customer applications in which the malfunction or failure of a passive electronic component could endanger human life or health (e.g. in accident prevention or life-saving systems), it must therefore be ensured by means of suitable design of the customer application or other action taken by the customer (e.g. installation of protective circuitry or redundancy) that no injury or damage is sustained by third parties in the event of malfunction or failure of a passive electronic component.
3. **The warnings, cautions and product-specific notes must be observed.**
4. In order to satisfy certain technical requirements, **some of the products described in this publication may contain substances subject to restrictions in certain jurisdictions (e.g. because they are classed as “hazardous”)**. Useful information on this will be found in our Material Data Sheets on the Internet ([www.epcos.com/material](http://www.epcos.com/material)). Should you have any more detailed questions, please contact our sales offices.
5. We constantly strive to improve our products. Consequently, **the products described in this publication may change from time to time**. The same is true of the corresponding product specifications. Please check therefore to what extent product descriptions and specifications contained in this publication are still applicable before or when you place an order. We also **reserve the right to discontinue production and delivery of products**. Consequently, we cannot guarantee that all products named in this publication will always be available.
6. Unless otherwise agreed in individual contracts, **all orders are subject to the current version of the “General Terms of Delivery for Products and Services in the Electrical Industry” published by the German Electrical and Electronics Industry Association (ZVEI)**.
7. The trade names EPCOS, EPCOS-JONES, BAOKE, Alu-X, CeraDiode, CSSP, MLSC, PhaseCap, PhaseMod, SIFERRIT, SIFI, SIKOREL, SilverCap, SIMID, SIOV, SIP5D, SIP5K, UltraCap, WindCap are **trademarks registered or pending** in Europe and in other countries. Further information will be found on the Internet at [www.epcos.com/trademarks](http://www.epcos.com/trademarks).