

Small Signal Zener Diodes, Dual

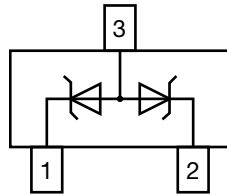
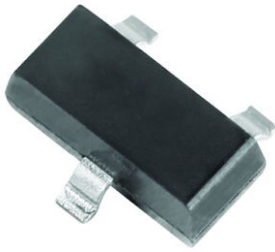

FEATURES

- These diodes are also available in other case styles and configurations including: the dual diode common cathode configuration with type designation DZ23, the single diode SOT-23 case with the type designation BZX84C, and the single diode SOD-123 case with the type designation BZT52C
- Dual silicon planar Zener diodes, common anode
- The Zener voltages are graded according to the international E 24 standard
- The parameters are valid for both diodes in one case. ΔV_Z and Δr_{zj} of the two diodes in one case is $\leq 5\%$
- AEC-Q101 qualified
- Compliant to RoHS Directive 2002/95/EC and in accordance to WEEE 2002/96/EC

RoHS
COMPLIANT

PRIMARY CHARACTERISTICS		
PARAMETER	VALUE	UNIT
V_Z range nom.	2.7 to 51	V
Test current I_{ZT}	5	mA
V_Z specification	Pulse current	
Int. construction	Dual	

ORDERING INFORMATION			
DEVICE NAME	ORDERING CODE	TAPED UNITS PER REEL	MINIMUM ORDER QUANTITY
AZ23-V-series	AZ23-V-series-GS18	10 000 (8 mm tape on 13" reel)	10 000
AZ23-V-series	AZ23-V-series-GS08	3000 (8 mm tape on 7" reel)	15 000

PACKAGE				
PACKAGE NAME	WEIGHT	MOLDING COMPOUND FLAMMABILITY RATING	MOISTURE SENSITIVITY LEVEL	SOLDERING CONDITIONS
SOT-23	8.8 mg	UL 94 V-0	MSL level 1 (according J-STD-020)	260 °C/10 s at terminals

ABSOLUTE MAXIMUM RATINGS ($T_{amb} = 25\text{ °C}$, unless otherwise specified)				
PARAMETER	TEST CONDITION	SYMBOL	VALUE	UNIT
Power dissipation	Device on fiberglass substrate, see layout on page 6	P_{tot}	300	mW
Junction to ambient air	Device on fiberglass substrate, see layout on page 6	R_{thJA}	420	K/W
Junction temperature		T_j	150	°C
Storage temperature range		T_{stg}	- 65 to + 150	°C



ELECTRICAL CHARACTERISTICS ($T_{amb} = 25\text{ }^{\circ}\text{C}$, unless otherwise specified)												
PART NUMBER	MARKING CODE	ZENER VOLTAGE RANGE ⁽¹⁾			TEST CURRENT		REVERSE VOLTAGE		DYNAMIC RESISTANCE		TEMPERATURE COEFFICIENT OF ZENER VOLTAGE	
		V_Z at I_{ZT1}			I_{ZT1}	I_{ZT2}	V_R at I_R		Z_Z at I_{ZT1}	Z_{ZK} at I_{ZT2}	α_{VZ} at I_{ZT}	
		V			mA		V	nA	Ω		$10^{-4}/^{\circ}\text{C}$	
		MIN.	NOM.	MAX.			MAX.		MAX.	MAX.	MIN.	MAX.
AZ23C2V7-V	D1	2.5	2.7	2.9	5	1	-	-	75 (< 83)	< 500	- 9	- 4
AZ23C3V0-V	D2	2.8	3.0	3.2	5	1	-	-	80 (< 95)	< 500	- 9	- 3
AZ23C3V3-V	D3	3.1	3.3	3.5	5	1	-	-	80 (< 95)	< 500	- 8	- 3
AZ23C3V6-V	D4	3.4	3.6	3.8	5	1	-	-	80 (< 95)	< 500	- 8	- 3
AZ23C3V9-V	D5	3.7	3.9	4.1	5	1	-	-	80 (< 95)	< 500	- 7	- 3
AZ23C4V3-V	D6	4	4.3	4.6	5	1	-	-	80 (< 95)	< 500	- 6	- 1
AZ23C4V7-V	D7	4.4	4.7	5	5	1	-	-	70 (< 78)	< 500	- 5	2
AZ23C5V1-V	D8	4.8	5.1	5.4	5	1	> 0.8	100	30 (< 60)	< 480	- 3	4
AZ23C5V6-V	D9	5.2	5.6	6	5	1	> 1	100	10 (< 40)	< 400	- 2	6
AZ23C6V2-V	D10	5.8	6.2	6.6	5	1	> 2	100	4.8 (< 10)	< 200	- 1	7
AZ23C6V8-V	D11	6.4	6.8	7.2	5	1	> 3	100	4.5 (< 8)	< 150	2	7
AZ23C7V5-V	D12	7	7.5	7.9	5	1	> 5	100	4 (< 7)	< 50	- 3	7
AZ23C8V2-V	D13	7.7	8.2	8.7	5	1	> 6	100	4.5 (< 7)	< 50	4	7
AZ23C9V1-V	D14	8.5	9.1	9.6	5	1	> 7	100	4.8 (< 10)	< 50	5	8
AZ23C10-V	D15	9.4	10	10.6	5	1	> 7.5	100	5.2 (< 15)	< 70	5	8
AZ23C11-V	D16	10.4	11	11.6	5	1	> 8.5	100	6 (< 20)	< 70	5	9
AZ23C12-V	D17	11.4	12	12.7	5	1	> 9	100	7 (< 20)	< 90	6	9
AZ23C13-V	D18	12.4	13	14.1	5	1	> 10	100	9 (< 25)	< 110	7	9
AZ23C15-V	D19	13.8	15	15.6	5	1	> 11	100	11 (< 30)	< 110	7	9
AZ23C16-V	D20	15.3	16	17.1	5	1	> 12	100	13 (< 40)	< 170	8	9.5
AZ23C18-V	D21	16.8	18	19.1	5	1	> 14	100	18 (< 50)	< 170	8	9.5
AZ23C20-V	D22	18.8	20	21.2	5	1	> 15	100	20 (< 50)	< 220	8	10
AZ23C22-V	D23	20.8	22	23.3	5	1	> 17	100	25 (< 55)	< 220	8	10
AZ23C24-V	D24	22.8	24	25.6	5	1	> 18	100	28 (< 80)	< 220	8	10
AZ23C27-V	D25	25.1	27	28.9	5	1	> 20	100	30 (< 80)	< 250	8	10
AZ23C30-V	D26	28	30	32	5	1	> 22.5	100	35 (< 80)	< 250	8	10
AZ23C33-V	D27	31	33	35	5	1	> 25	100	40 (< 80)	< 250	8	10
AZ23C36-V	D28	34	36	38	5	1	> 27	100	40 (< 90)	< 250	8	10
AZ23C39-V	D29	37	39	41	5	1	> 29	100	50 (< 90)	< 300	10	12
AZ23C43-V	D30	40	43	46	5	1	> 32	100	60 (< 100)	< 700	10	12
AZ23C47-V	D31	44	47	50	5	1	> 35	100	70 (< 100)	< 750	10	12
AZ23C51-V	D32	48	51	54	5	1	> 38	100	70 (< 100)	< 750	10	12

Note⁽¹⁾ Tested with pulses $t_p = 5\text{ ms}$



ELECTRICAL CHARACTERISTICS ($T_{amb} = 25\text{ }^{\circ}\text{C}$, unless otherwise specified)												
PART NUMBER	MARKING CODE	ZENER VOLTAGE RANGE ⁽¹⁾			TEST CURRENT		REVERSE VOLTAGE		DYNAMIC RESISTANCE		TEMPERATURE COEFFICIENT OF ZENER VOLTAGE	
		V_Z at I_{ZT1}			I_{ZT1}	I_{ZT2}	V_R at I_R		Z_Z at I_{ZT1}	Z_{ZK} at I_{ZT2}	α_{VZ} at I_{ZT}	
		V			mA		V	nA	Ω		$10^{-4}/^{\circ}\text{C}$	
		MIN.	NOM.	MAX.			MAX.		MAX.	MAX.	MIN.	MAX.
AZ23B2V7-V	D1	2.65	2.7	2.75	5	1	-	-	75 (< 83)	< 500	- 9	- 4
AZ23B3V0-V	D2	2.94	3.0	3.06	5	1	-	-	80 (< 95)	< 500	- 9	- 3
AZ23B3V3-V	D3	3.23	3.3	3.37	5	1	-	-	80 (< 95)	< 500	- 8	- 3
AZ23B3V6-V	D4	3.53	3.6	3.67	5	1	-	-	80 (< 95)	< 500	- 8	- 3
AZ23B3V9-V	D5	3.82	3.9	3.98	5	1	-	-	80 (< 95)	< 500	- 7	- 3
AZ23B4V3-V	D6	4.21	4.3	4.39	5	1	-	-	80 (< 95)	< 500	- 6	- 1
AZ23B4V7-V	D7	4.61	4.7	4.79	5	1	-	-	70 (< 78)	< 500	- 5	2
AZ23B5V1-V	D8	5	5.1	5.2	5	1	> 0.8	100	30 (< 60)	< 480	- 3	4
AZ23B5V6-V	D9	5.49	5.6	5.71	5	1	> 1	100	10 (< 40)	< 400	- 2	6
AZ23B6V2-V	D10	6.08	6.2	6.32	5	1	> 2	100	4.8 (< 10)	< 200	- 1	7
AZ23B6V8-V	D11	6.66	6.8	6.94	5	1	> 3	100	4.5 (< 8)	< 150	2	7
AZ23B7V5-V	D12	7.35	7.5	7.65	5	1	> 5	100	4 (< 7)	< 50	- 3	7
AZ23B8V2-V	D13	8.04	8.2	8.36	5	1	> 6	100	4.5 (< 7)	< 50	4	7
AZ23B9V1-V	D14	8.92	9.1	9.28	5	1	> 7	100	4.8 (< 10)	< 50	5	8
AZ23B10-V	D15	9.8	10	10.2	5	1	> 7.5	100	5.2 (< 15)	< 70	5	8
AZ23B11-V	D16	10.8	11	11.2	5	1	> 8.5	100	6 (< 20)	< 70	5	9
AZ23B12-V	D17	11.8	12	12.2	5	1	> 9	100	7 (< 20)	< 90	6	9
AZ23B13-V	D18	12.7	13	13.3	5	1	> 10	100	9 (< 25)	< 110	7	9
AZ23B15-V	D19	14.7	15	15.3	5	1	> 11	100	11 (< 30)	< 110	7	9
AZ23B16-V	D20	15.7	16	16.3	5	1	> 12	100	13 (< 40)	< 170	8	0.5
AZ23B18-V	D21	17.6	18	18.4	5	1	> 14	100	18 (< 50)	< 170	8	0.5
AZ23B20-V	D22	19.6	20	20.4	5	1	> 15	100	20 (< 50)	< 220	8	10
AZ23B22-V	D23	21.6	22	22.4	5	1	> 17	100	25 (< 55)	< 220	8	10
AZ23B24-V	D24	23.5	24	24.5	5	1	> 18	100	28 (< 80)	< 220	8	10
AZ23B27-V	D25	26.5	27	27.5	5	1	> 20	100	30 (< 80)	< 250	8	10
AZ23B30-V	D26	29.4	30	30.6	5	1	> 22.5	100	35 (< 80)	< 250	8	10
AZ23B33-V	D27	32.3	33	33.7	5	1	> 25	100	40 (< 80)	< 250	8	10
AZ23B36-V	D28	35.3	36	36.7	5	1	> 27	100	40 (< 90)	< 250	8	10
AZ23B39-V	D29	38.2	39	39.8	5	1	> 29	100	50 (< 90)	< 300	10	12
AZ23B43-V	D30	42.1	43	43.9	5	1	> 32	100	60 (< 100)	< 700	10	12
AZ23B47-V	D31	46.1	47	47.9	5	1	> 35	100	70 (< 100)	< 750	10	12
AZ23B51-V	D32	50	51	52	5	1	> 38	100	70 (< 100)	< 750	10	12

Note

⁽¹⁾ Tested with pulses $t_p = 5\text{ ms}$

BASIC CHARACTERISTICS ($T_{amb} = 25\text{ }^{\circ}\text{C}$, unless otherwise specified)

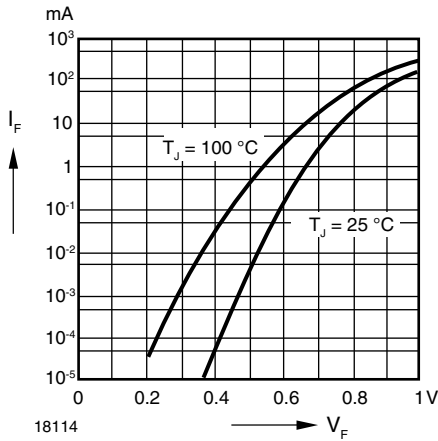

Fig. 1 - Forward Characteristics

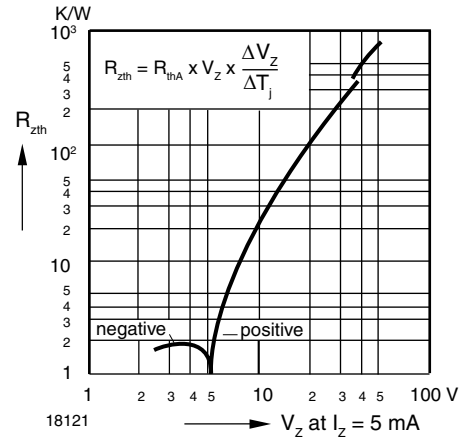

Fig. 4 - Thermal Differential Resistance vs. Zener Voltage

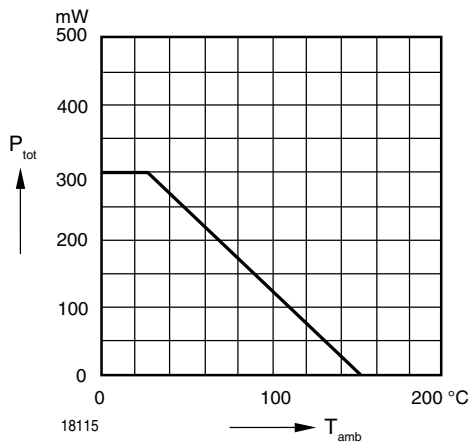

Fig. 2 - Admissible Power Dissipation vs. Ambient Temperature

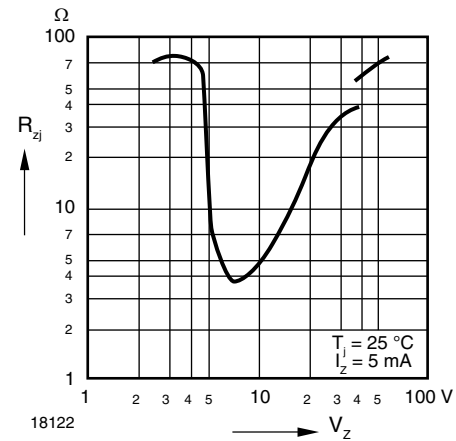

Fig. 5 - Dynamic Resistance vs. Zener Voltage

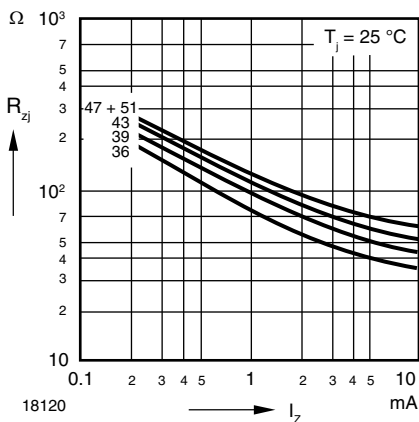

Fig. 3 - Dynamic Resistance vs. Zener Current

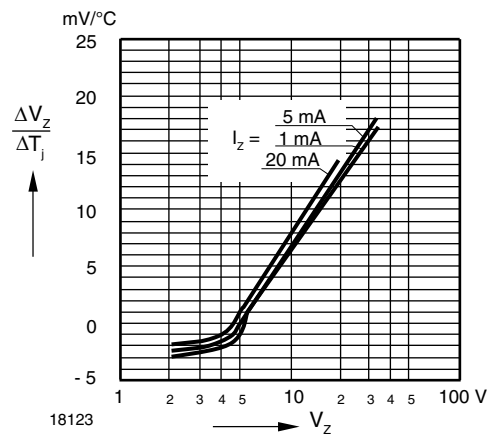

Fig. 6 - Temperature Dependence of Zener Voltage vs. Zener Voltage

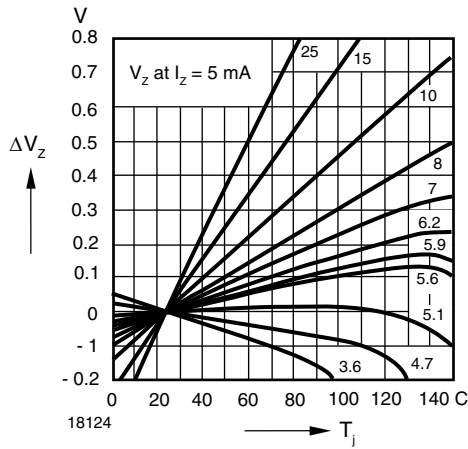

Fig. 7 - Change of Zener Voltage vs. Junction Temperature



Fig. 10 - Change of Zener Voltage from Turn-on up to the Point of Thermal Equilibrium vs. Zener Voltage

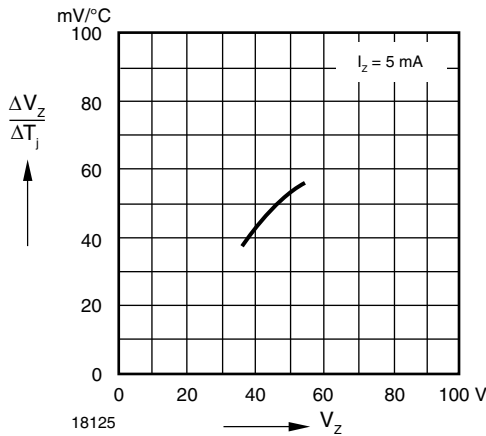

Fig. 8 - Temperature Dependence of Zener Voltage vs. Zener Voltage

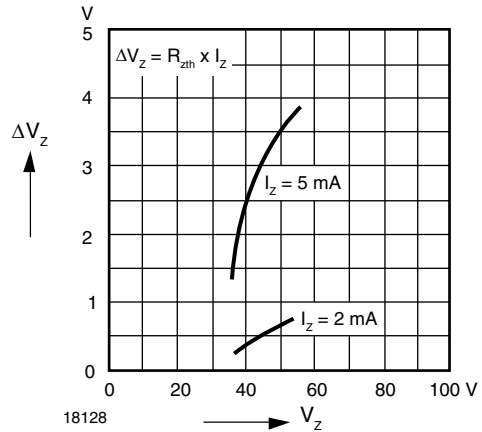

Fig. 11 - Change of Zener Voltage from Turn-on up to the Point of Thermal Equilibrium vs. Zener Voltage

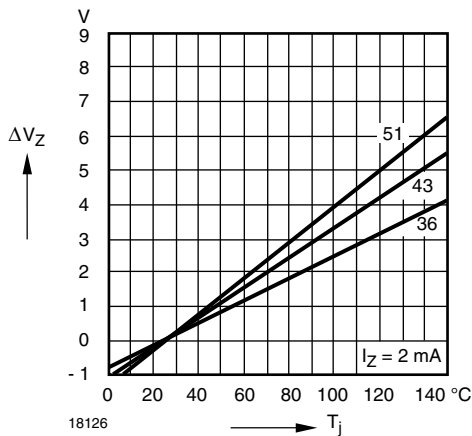

Fig. 9 - Change of Zener Voltage vs. Junction Temperature

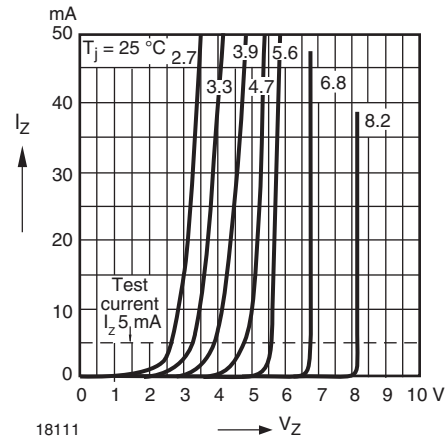

Fig. 12 - Breakdown Characteristics

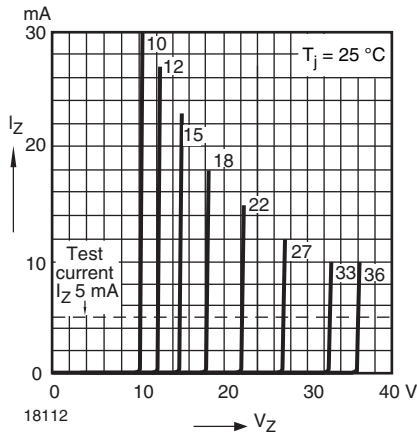

Fig. 13 - Breakdown Characteristics

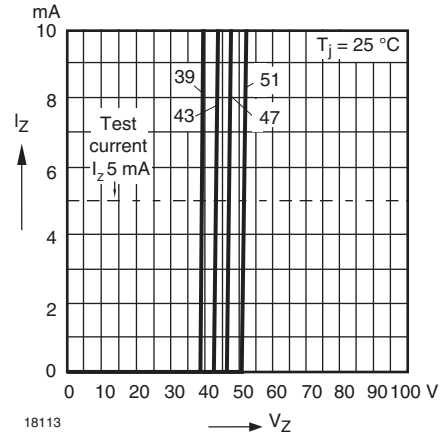
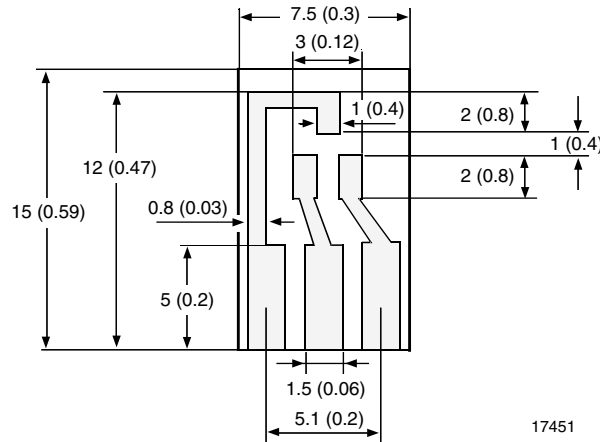

Fig. 14 - Breakdown Characteristics

LAYOUT FOR R_{thJA} TEST

Thickness: fiberglass 0.059" (1.5 mm)

Copper leads 0.012" (0.3 mm)





PACKAGE DIMENSIONS in millimeters (inches): SOT-23

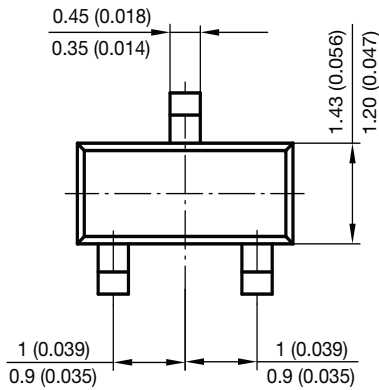
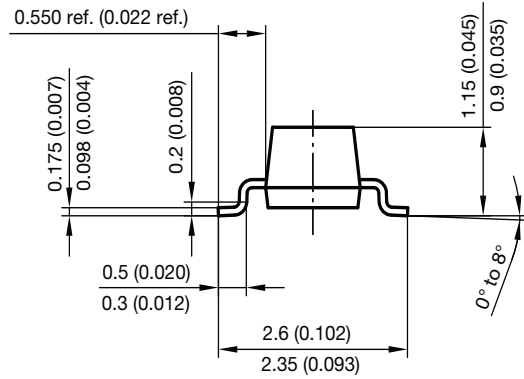
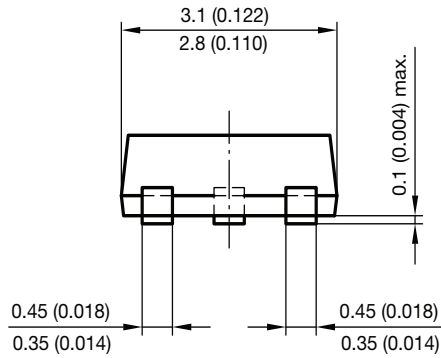

Foot print recommendation:

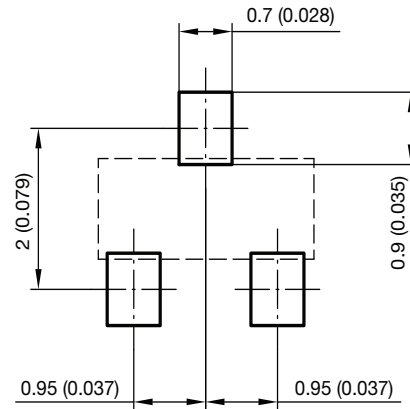

Document no.: 6.541-5014.01-4
Rev. 8 - Date: 23.Sept.2009
17418



Disclaimer

ALL PRODUCT, PRODUCT SPECIFICATIONS AND DATA ARE SUBJECT TO CHANGE WITHOUT NOTICE TO IMPROVE RELIABILITY, FUNCTION OR DESIGN OR OTHERWISE.

Vishay Intertechnology, Inc., its affiliates, agents, and employees, and all persons acting on its or their behalf (collectively, "Vishay"), disclaim any and all liability for any errors, inaccuracies or incompleteness contained in any datasheet or in any other disclosure relating to any product.

Vishay makes no warranty, representation or guarantee regarding the suitability of the products for any particular purpose or the continuing production of any product. To the maximum extent permitted by applicable law, Vishay disclaims (i) any and all liability arising out of the application or use of any product, (ii) any and all liability, including without limitation special, consequential or incidental damages, and (iii) any and all implied warranties, including warranties of fitness for particular purpose, non-infringement and merchantability.

Statements regarding the suitability of products for certain types of applications are based on Vishay's knowledge of typical requirements that are often placed on Vishay products in generic applications. Such statements are not binding statements about the suitability of products for a particular application. It is the customer's responsibility to validate that a particular product with the properties described in the product specification is suitable for use in a particular application. Parameters provided in datasheets and/or specifications may vary in different applications and performance may vary over time. All operating parameters, including typical parameters, must be validated for each customer application by the customer's technical experts. Product specifications do not expand or otherwise modify Vishay's terms and conditions of purchase, including but not limited to the warranty expressed therein.

Except as expressly indicated in writing, Vishay products are not designed for use in medical, life-saving, or life-sustaining applications or for any other application in which the failure of the Vishay product could result in personal injury or death. Customers using or selling Vishay products not expressly indicated for use in such applications do so at their own risk and agree to fully indemnify and hold Vishay and its distributors harmless from and against any and all claims, liabilities, expenses and damages arising or resulting in connection with such use or sale, including attorneys fees, even if such claim alleges that Vishay or its distributor was negligent regarding the design or manufacture of the part. Please contact authorized Vishay personnel to obtain written terms and conditions regarding products designed for such applications.

No license, express or implied, by estoppel or otherwise, to any intellectual property rights is granted by this document or by any conduct of Vishay. Product names and markings noted herein may be trademarks of their respective owners.

Material Category Policy

Vishay Intertechnology, Inc. hereby certifies that all its products that are identified as RoHS-Compliant fulfill the definitions and restrictions defined under Directive 2011/65/EU of The European Parliament and of the Council of June 8, 2011 on the restriction of the use of certain hazardous substances in electrical and electronic equipment (EEE) - recast, unless otherwise specified as non-compliant.

Please note that some Vishay documentation may still make reference to RoHS Directive 2002/95/EC. We confirm that all the products identified as being compliant to Directive 2002/95/EC conform to Directive 2011/65/EU.