

Part Number: WP934CA/2SRD-90

Super Bright Red

### Features

- PRE-TRIMMED LEADS FOR PC MOUNTING.
- I.C. COMPATIBLE.
- BLACK CASE ENHANCES CONTRAST RATIO.
- WIDE VIEWING ANGLE.
- HIGH RELIABILITY LIFE MEASURED IN YEARS.
- UL RATING : 94V-0.
- HOUSING MATERIAL: TYPE 66 NYLON.
- RoHS COMPLIANT.

### Description

The Super Bright Red source color devices are made with Gallium Aluminum Arsenide Red Light Emitting Diode.

### Package Dimensions

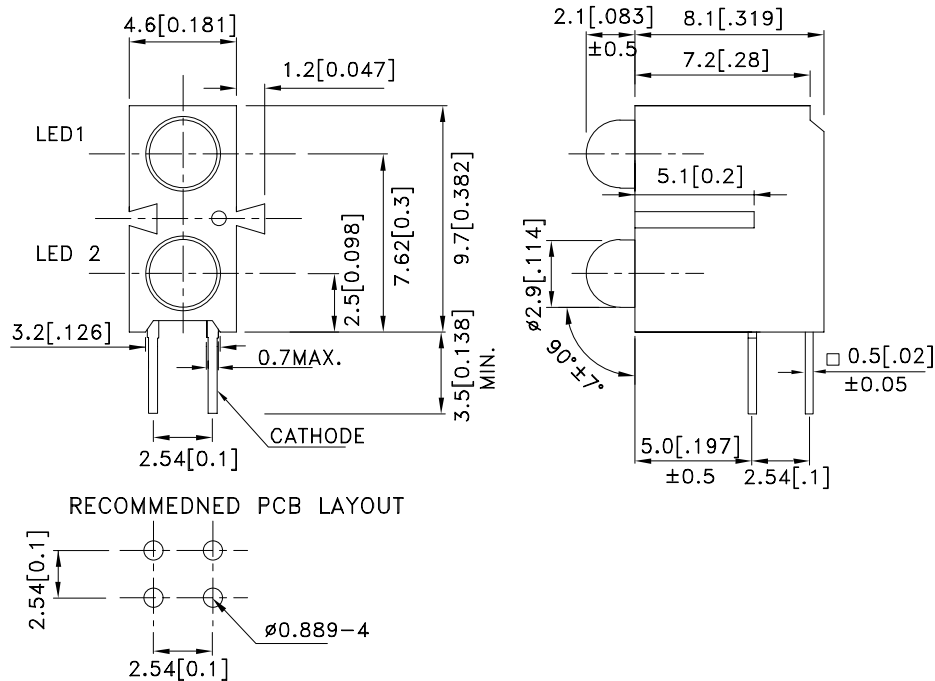

#### Notes:

1. All dimensions are in millimeters (inches).
2. Tolerance is  $\pm 0.25 (0.01")$  unless otherwise noted.
3. Lead spacing is measured where the leads emerge from the package.
4. Specifications are subject to change without notice.



## Selection Guide

Part No.	Dice	Lens Type	Iv (mcd) [2] @ 20mA		Viewing Angle [1]
			Min.	Typ.	2θ1/2
WP934CA/2SRD-90	Super Bright Red (GaAlAs)	RED DIFFUSED	110	300	40°

Notes:

1. θ1/2 is the angle from optical centerline where the luminous intensity is 1/2 the optical centerline value.
2. Luminous intensity/ luminous Flux: +/-15%.

## Electrical / Optical Characteristics at TA=25°C

Symbol	Parameter	Device	Typ.	Max.	Units	Test Conditions
λpeak	Peak Wavelength	Super Bright Red	660		nm	IF=20mA
λD [1]	Dominant Wavelength	Super Bright Red	640		nm	IF=20mA
Δλ1/2	Spectral Line Half-width	Super Bright Red	20		nm	IF=20mA
C	Capacitance	Super Bright Red	45		pF	VF=0V;f=1MHz
VF [2]	Forward Voltage	Super Bright Red	1.85	2.5	V	IF=20mA
IR	Reverse Current	Super Bright Red		10	uA	VR = 5V

Notes:

1. Wavelength: +/-1nm.
2. Forward Voltage: +/-0.1V.

## Absolute Maximum Ratings at TA=25°C

Parameter	Super Bright Red	Units
Power dissipation	75	mW
DC Forward Current	30	mA
Peak Forward Current [1]	155	mA
Reverse Voltage	5	V
Operating/Storage Temperature	-40°C To +85°C	
Lead Solder Temperature [2]	260°C For 3 Seconds	
Lead Solder Temperature [3]	260°C For 5 Seconds	

Notes:

1. 1/10 Duty Cycle, 0.1ms Pulse Width.
2. 2mm below package base.
3. 5mm below package base.

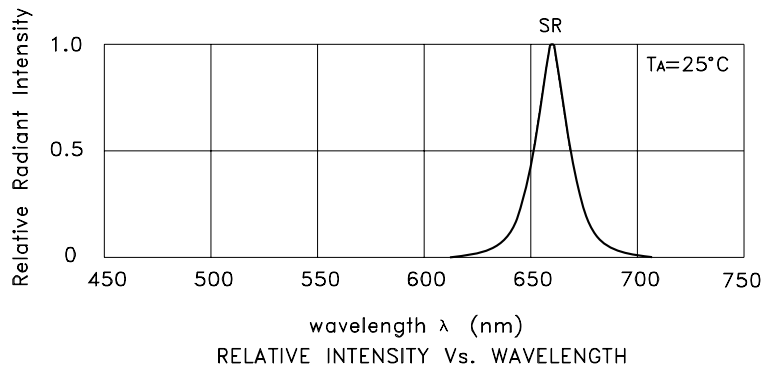

## Super Bright Red WP934CA/2SRD-90

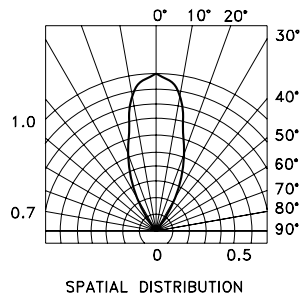
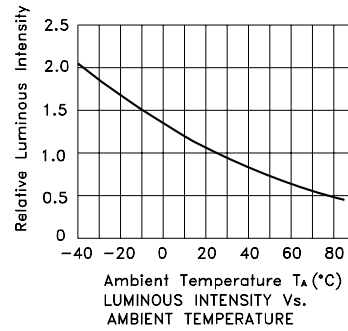
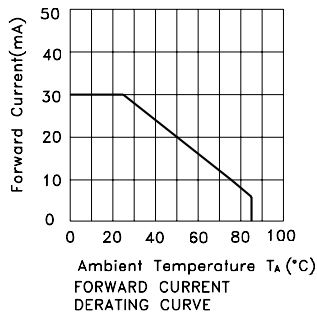
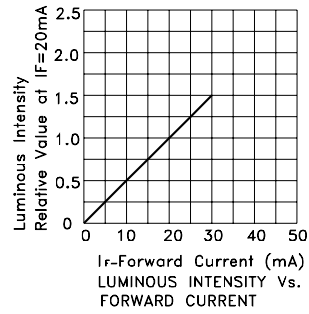
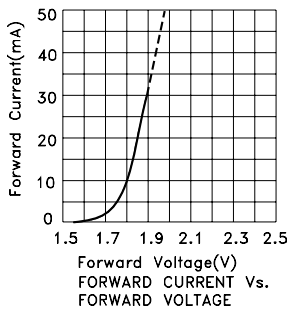

# Kingbright

## PACKING & LABEL SPECIFICATIONS

WP934CA/2SRD-90

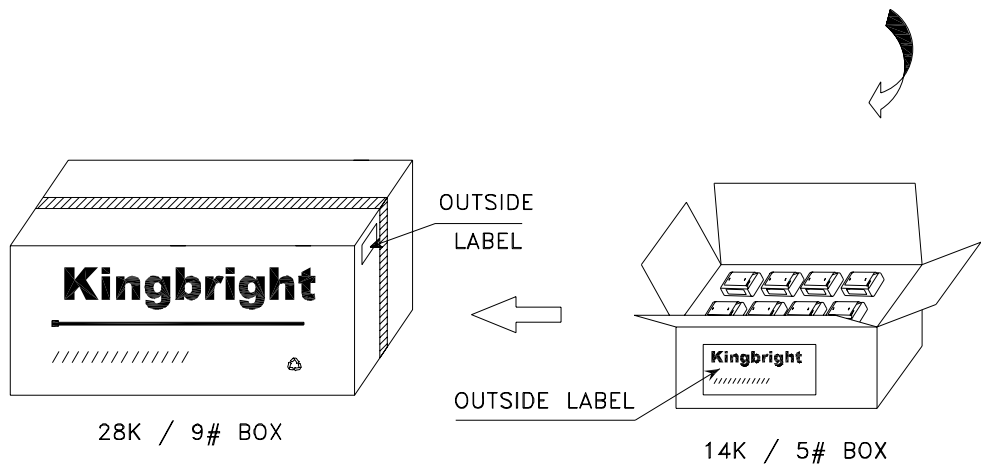
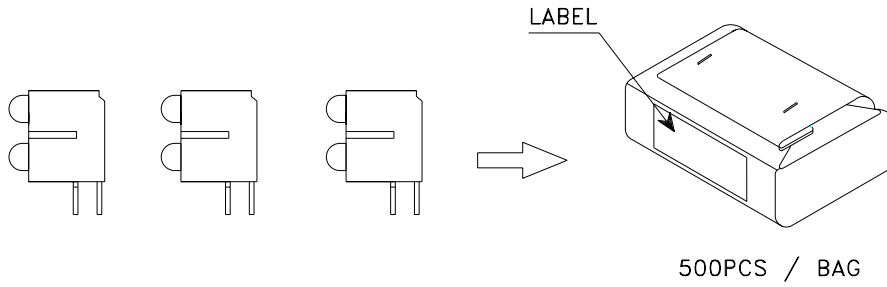

<h1>Kingbright</h1>	
Q.C.	QC XX XX XX PASSED
TYPE NO : WP934CAxxx	
QUANTITY : 500 pcs	
S/N : XX	CODE: XX
LOT NO :  xx-xxxxx	
RoHS Compliant	

Downloaded from [Elcodis.com](http://Elcodis.com) electronic components distributor