

T-41-83

HIGH-VOLTAGE OPTOCOUPLER

The CNX62 is an optocoupler consisting of an infrared emitting GaAs diode and a silicon npn phototransistor in a dual-in-line (DIL) plastic envelope. The base is not connected.

Features

- High current transfer ratio and a low saturation voltage suitable for use with TTL integrated circuits
- High degree of AC and DC insulation (3750 V RMS and 5300 V DC)
- Working voltage of 2.5 kV (DC)

UL — Covered under UL component recognition FILE E90700

VDE — Approved according to VDE 0883/6.80
Reference voltage (VDE 0110b Tab 4): AC 500 V/DC 600 V — ←

Complied for reinforced isolation at 250 V AC with:
DIN 57 804/VDE 0804/1.83 (isolation group C) ←
DIN VDE 0860/8.86/HD 195 S4 ←

BSI — Certification according to BS415:1979 (Home appliance) ←

QUICK REFERENCE DATA

Diode

Continuous reverse voltage	V_R	max.	5 V
DC forward current	I_F	max.	100 mA
peak value; $t_{on} = 10 \mu s$; $\delta = 0.01$	I_{FRM}	max.	3 A
Total power dissipation up to $T_{amb} = 25 \text{ }^\circ\text{C}$	P_{tot}	max.	200 mW

Transistor

Collector-emitter voltage (open base)	V_{CEO}	max.	50 V
Total power dissipation up to $T_{amb} = 25 \text{ }^\circ\text{C}$	P_{tot}	max.	200 mW

Optocoupler

Output/input DC current transfer ratio (CTR) $I_F = 10 \text{ mA}$; $V_{CE} = 0.4 \text{ V}$	I_C/I_F	min.	0.4
Collector cut-off current (dark) $V_{CC} = 10 \text{ V}$; working voltage = 2.5 kV DC I_F (diode) = 0 (see Fig.4)	I_{CEW}	max.	200 nA
Collector-emitter saturation voltage $I_F = 10 \text{ mA}$; $I_C = 4 \text{ mA}$	V_{CEsat}	max.	0.4 V
Isolation voltage DC	V_{IORM}	min.	5.3 kV
AC (RMS value)		min.	3.75 kV

MECHANICAL DATA

SOT174 (see Fig.1).

T-41-83

MECHANICAL DATA

Dimensions in mm

Fig.1 SOT174.

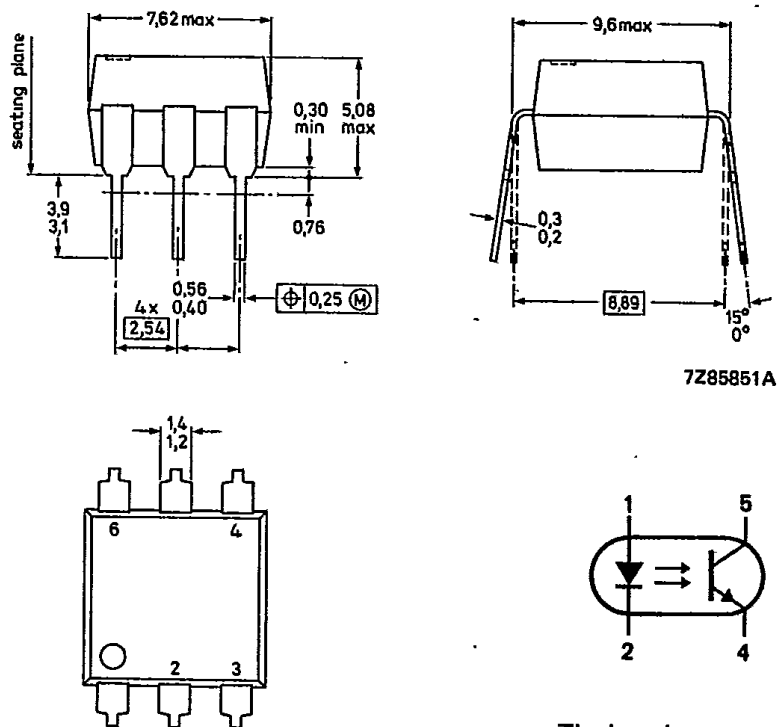

7Z85851A

The base is not connected.

RATINGS

Limiting values in accordance with the Absolute Maximum System (IEC 134)

Diode

Continuous reverse voltage	V_R	max.	5 V
DC forward current	I_F	max.	100 mA
peak value; $t_{on} = 10 \mu s$; $\delta = 0.01$	I_{FRM}	max.	3 A
Total power dissipation up to $T_{amb} = 25 \text{ }^\circ\text{C}$ (when mounted on a printed circuit board: $T_{amb} = 45 \text{ }^\circ\text{C}$)	P_{tot}	max.	200 mW

Transistor

Collector-emitter voltage (open base)	V_{CEO}	max.	50 V
Emitter-collector voltage	V_{ECO}	max.	7 V
DC collector current	I_C	max.	100 mA
Total power dissipation up to $T_{amb} = 25 \text{ }^\circ\text{C}$ (when mounted on a printed circuit board: $T_{amb} = 45 \text{ }^\circ\text{C}$)	P_{tot}	max.	200 mW

Optocoupler

Storage temperature range	T_{stg}	-55 to + 150 °C
Junction temperature	T_j	max. 125 °C
Soldering temperature up to the seating plane; $t_{sld} < 10$ s	T_{sld}	max. 260 °C

THERMAL RESISTANCE

From junction to ambient in free air diode	$R_{th\ j-a}$	=	500 K/W
transistor	$R_{th\ j-a}$	=	500 K/W
From junction to ambient when mounted on PCB diode	$R_{th\ j-a}$	=	400 K/W
transistor	$R_{th\ j-a}$	=	400 K/W

ISOLATION RELATED VALUES

External air gap (clearance) input terminals to output terminals	$L(IO1)$	min.	8.4 mm
External tracking path (creepage distance) input terminals to output terminals	$L(IO2)$	min.	7.0 mm
Tracking resistance (KB-value)			KB-100/A
Internal plastic gap (clearance) isolation thickness between emitter and receiver		min.	1 mm

CHARACTERISTICS

$T_j = 25$ °C unless otherwise specified

Diode

Forward voltage $I_F = 10$ mA	V_F	typ. max.	1.15 V 1.50 V
Reverse current $V_R = 5$ V	I_R	max.	10 μ A

Transistor

Collector-emitter breakdown voltage $I_C = 1$ mA	$V_{(BR)CEO}$	min.	50 V
Emitter-collector breakdown voltage $I_E = 0.1$ mA	$V_{(BR)ECO}$	min.	7 V
Collector cut-off current (dark); diode $I_F = 0$ $V_{CE} = 10$ V	I_{CEO}	typ. max.	2 nA 50 nA
$V_{CE} = 10$ V; $T_{amb} = 70$ °C	I_{CEO}	max.	10 μ A

Optocoupler

Output/input DC current transfer ratio (CTR) $I_F = 10$ mA; $V_{CE} = 0.4$ V	I_C/I_F	min. typ.	0.4 0.8
$I_F = 10$ mA; $V_{CE} = 5$ V	I_C/I_F	typ.	1.5
Collector cut-off current (light) $T_{amb} \leq 70$ °C; $V_F = 0.8$ V; $V_{CE} = 15$ V	$I_{CE(L)}$	max.	15 μ A
$T_{amb} \leq 70$ °C; $I_F = 2$ mA; $V_{CE} = 0.4$ V	$I_{CE(L)}$	min.	150 μ A

Optocoupler (continued)

Collector-emitter saturation voltage

$I_F = 10 \text{ mA}; I_C = 4 \text{ mA}$

V_{CEsat}	typ.	0.19 V
	max.	0.40 V

Collector cut-off current (dark) at working voltage 2.5 kV DC;

$V_{CC} = 10 \text{ V}; T_j = 25 \text{ }^\circ\text{C}$ (see Fig.4 and notes 1 and 2)

$V_{CC} = 10 \text{ V}; T_j = 70 \text{ }^\circ\text{C}$ (see Fig.4 and notes 1 and 2)

I_{CEW}	max.	200 nA
	max.	100 μA

Isolation voltage; $t = 1 \text{ min}$
(see note 3)

DC
AC (RMS value)

V_{IORM}	min.	5.3 kV
	min.	3.75 kV

Capacitance between input and output

$V = 0; f = 1 \text{ MHz}$

C_{io}	typ.	0.6 pF
----------	------	--------

Insulation resistance between input and output

$V_{IO} = \pm 1000 \text{ V}$

R_{IO}	min.	10 G Ω
	typ.	1 T Ω

Switching times (see Figs 2 and 3)

Turn-on time

$I_C = 2 \text{ mA}; V_{CC} = 5 \text{ V}; R_L = 100 \Omega$

$I_C = 2 \text{ mA}; V_{CC} = 5 \text{ V}; R_L = 1 \text{ k}\Omega$

t_{on}	typ.	3 μs
	typ.	12 μs

Turn-off time

$I_C = 2 \text{ mA}; V_{CC} = 5 \text{ V}; R_L = 100 \Omega$

$I_C = 2 \text{ mA}; V_{CC} = 5 \text{ V}; R_L = 1 \text{ k}\Omega$

t_{off}	typ.	3 μs
	typ.	12 μs

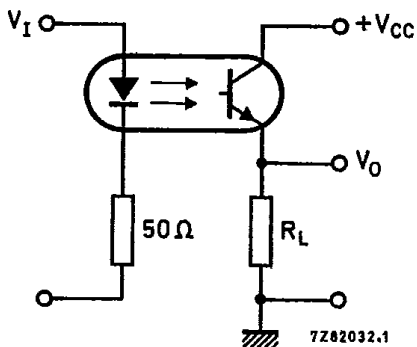

Fig.2 Switching circuit.

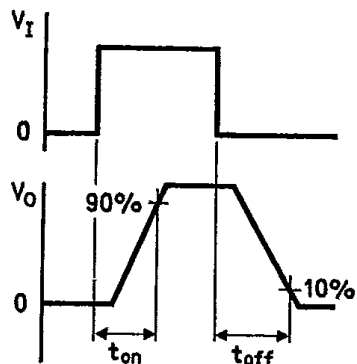

Fig.3 Waveforms.

Notes

1. The two parameters are tested on a sample basis for 1000 h.
2. This parameter is the maximum collector-emitter leakage current measured when a high voltage is applied between the shorted diode leads and the transistor emitter.
3. Every single product is tested by applying an isolation test voltage of 4500 V (RMS) for 2 seconds between the shorted input (diode) leads and the shorted output (phototransistor) leads.

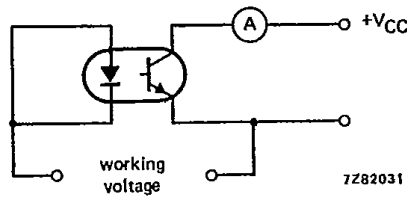

Fig. 4.

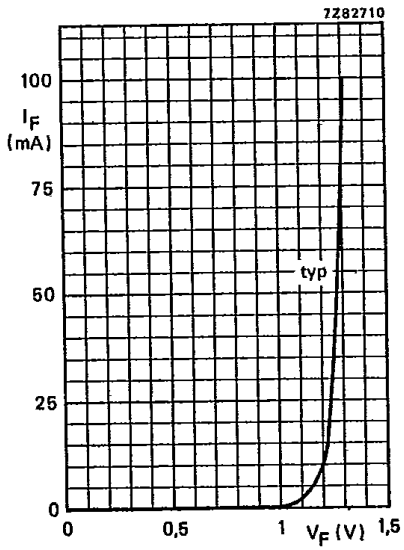

Fig. 5 $T_{amb} = 25\text{ }^{\circ}\text{C}$.

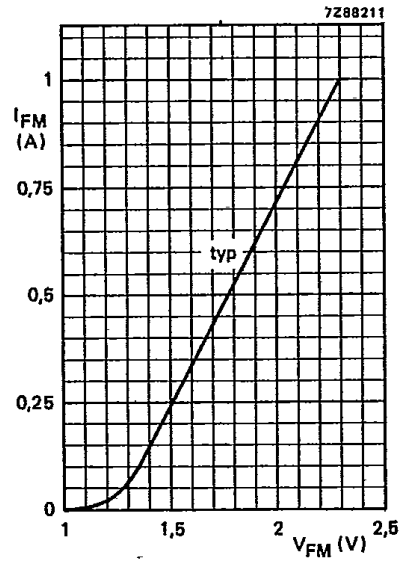

Fig. 6 $T_{amb} = 25\text{ }^{\circ}\text{C}$; $t_p = 10\text{ }\mu\text{s}$; $\delta = 0.01$.

T-41-83

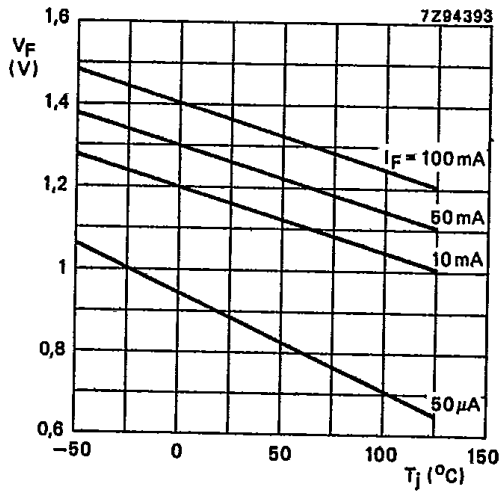

Fig.7 Typical values.

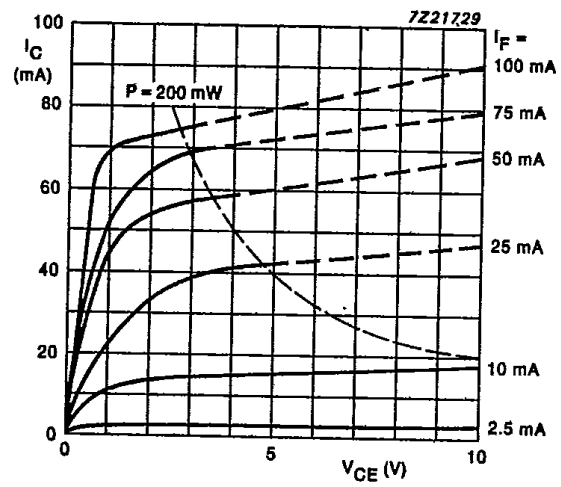

Fig.8 Typical values; $T_{amb} = 25$ °C.

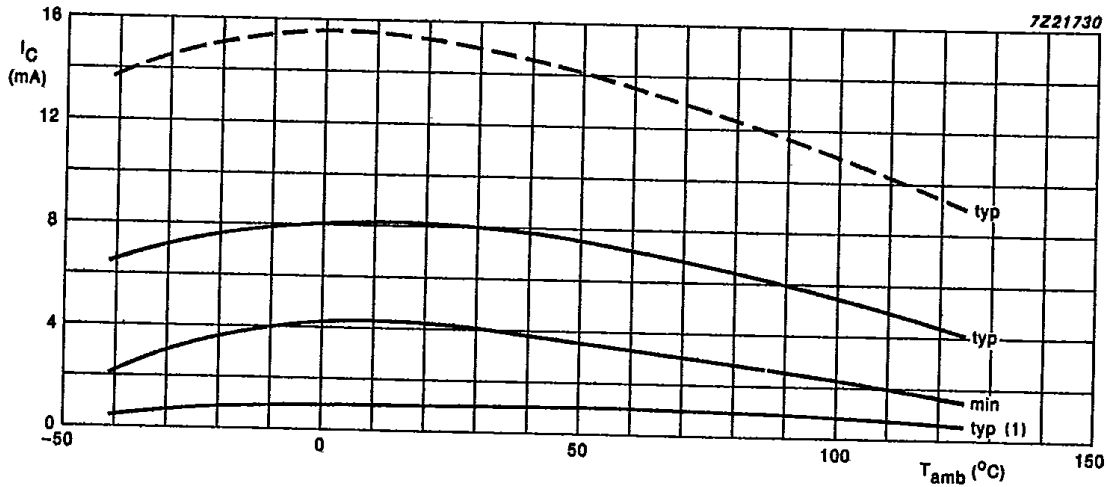

Fig.9 $I_F = 10$ mA; — $V_{CE} = 0.4$ V; - - - $V_{CE} = 5$ V.

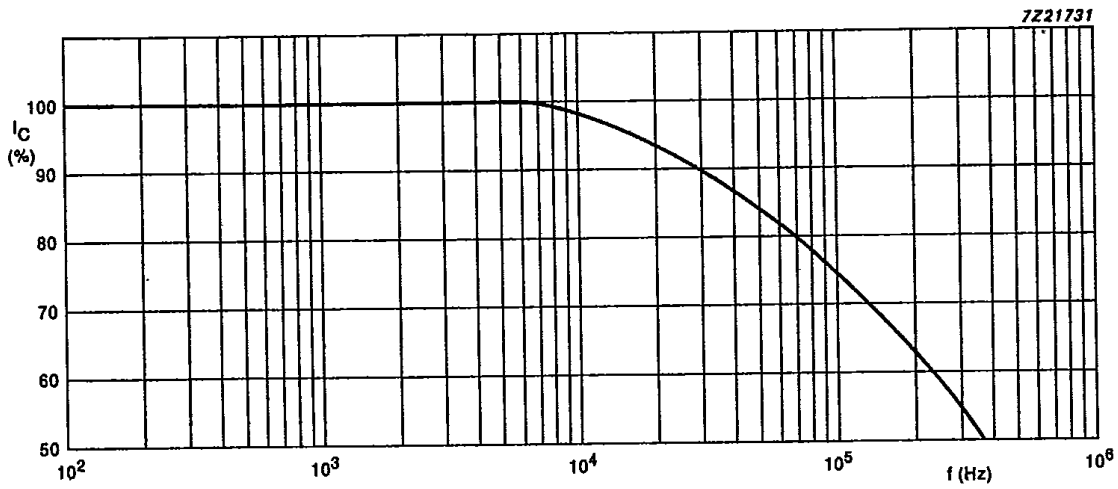

Fig.10 Typical values; $R_L = 1\text{ k}\Omega$; $I_C = 2\text{ mA}$; $V_{CC} = 5\text{ V}$; $T_{amb} = 25\text{ }^\circ\text{C}$.

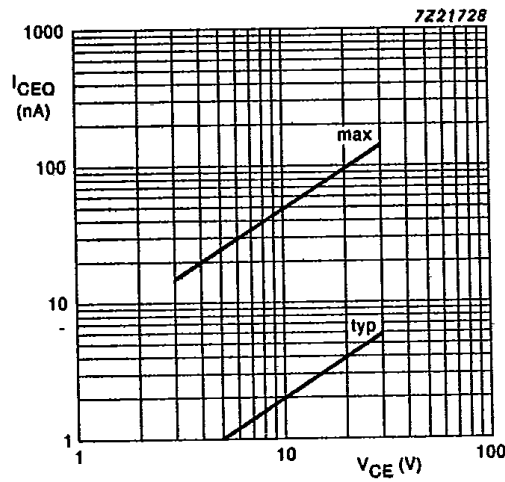

Fig.11 $T_j = 25\text{ }^\circ\text{C}$.

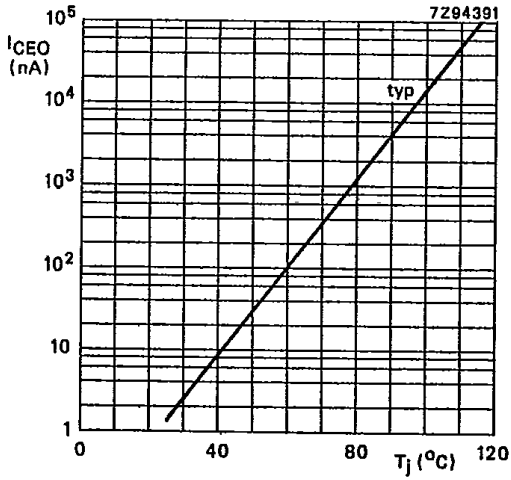

Fig. 12 $V_{CE} = 10$ V.

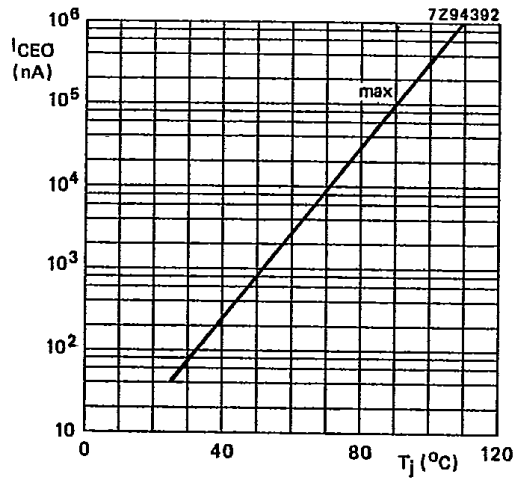

Fig. 13 $V_{CE} = 10$ V.

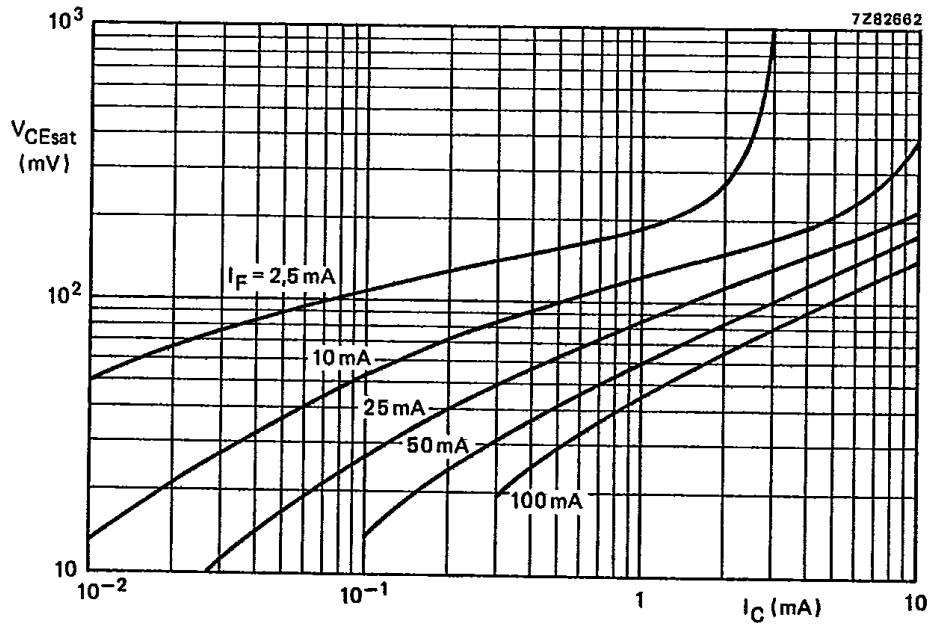

Fig. 14 $T_{amb} = 25$ °C; typical values.