

Typical Applications

This amplifier is ideal for use as a power amplifier for 2.2 - 2.7 GHz applications:

- BLUETOOTH
- MMDS

Features

- Gain: 20 dB
- Saturated Power: +30 dBm
- 32% PAE
- Supply Voltage: +2.75V to +5V
- Power Down Capability
- Low External Part Count

Functional Diagram

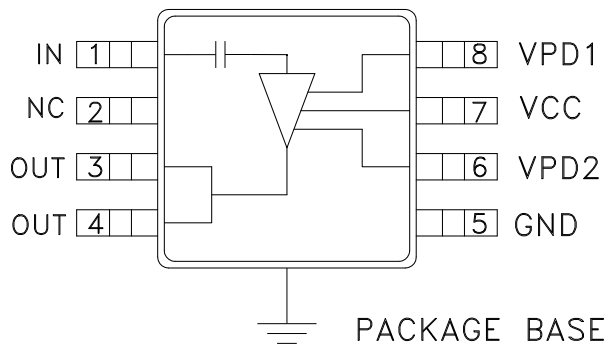

General Description

The HMC414MS8G & HMC414MS8GE are high efficiency GaAs InGaP Heterojunction Bipolar Transistor (HBT) MMIC Power amplifiers which operate between 2.2 and 2.8 GHz. The amplifier is packaged in a low cost, surface mount 8 leaded package with an exposed base for improved RF and thermal performance. With a minimum of external components, the amplifier provides 20 dB of gain, +30 dBm of saturated power at 32% PAE from a +5V supply voltage. The amplifier can also operate with a 3.6V supply. Vpd can be used for full power down or RF output power/current control.

Electrical Specifications, $T_A = +25^\circ \text{C}$, As a Function of V_s , $V_{pd} = 3.6\text{V}$

Parameter	$V_s = 3.6\text{V}$			$V_s = 5\text{V}$			Units
	Min.	Typ.	Max.	Min.	Typ.	Max.	
Frequency Range	2.2 - 2.8			2.2 - 2.8			GHz
Gain	17	20	25	17	20	25	dB
Gain Variation Over Temperature		0.03	0.04		0.03	0.04	dB/ °C
Input Return Loss		8			8		dB
Output Return Loss		9			9		dB
Output Power for 1 dB Compression (P1dB)	21	25		23	27		dBm
Saturated Output Power (P _{sat})		27			30		dBm
Output Third Order Intercept (IP3)	30	35		35	39		dBm
Noise Figure		6.5			7.0		dB
Supply Current (I _{cq})	V _{pd} = 0V / 3.6V			0.002 / 300			mA
Control Current (I _{pd})	V _{pd} = 3.6V			7			mA
Switching Speed	t _{ON} , t _{OFF}			45			ns

For price, delivery, and to place orders, please contact Hittite Microwave Corporation:
 20 Alpha Road, Chelmsford, MA 01824 Phone: 978-250-3343 Fax: 978-250-3373
 Order On-line at www.hittite.com



HMC414MS8G / 414MS8GE

**GaAs InGaP HBT MMIC
POWER AMPLIFIER, 2.2 - 2.8 GHz**

Gain vs. Temperature, Vs= 3.6V

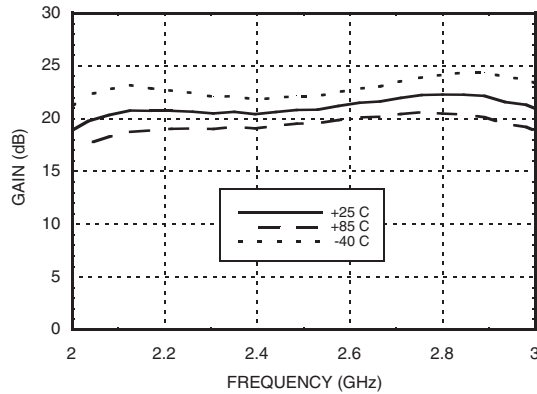

Gain vs. Temperature, Vs= 5V

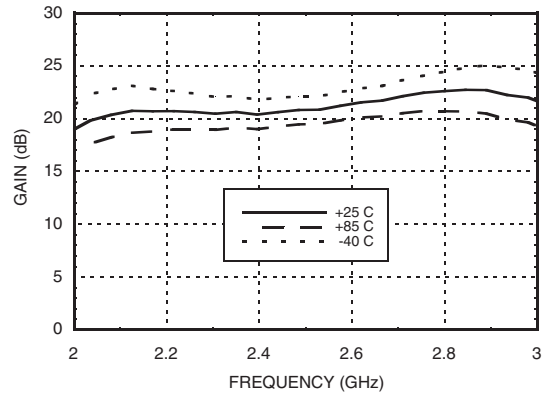

Return Loss, Vs= 3.6V

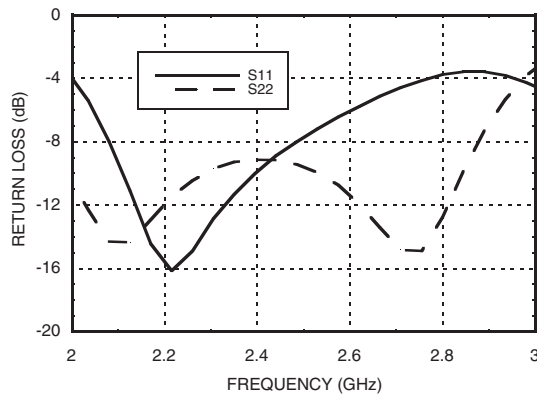

Return Loss, Vs= 5V

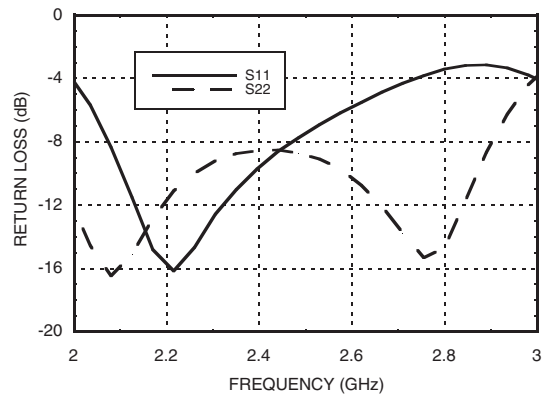

P1dB vs. Temperature, Vs= 3.6V

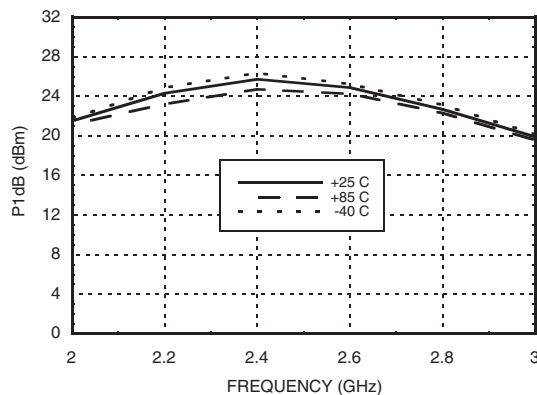

P1dB vs. Temperature, Vs= 5V

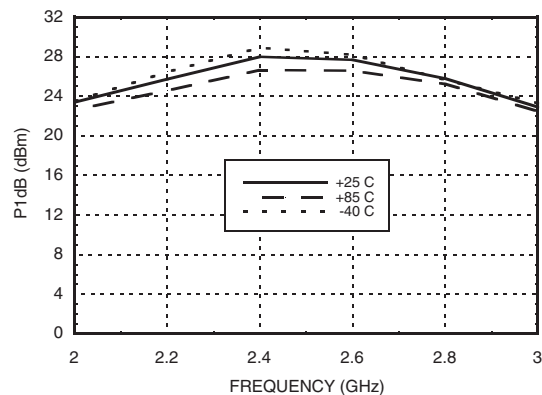

For price, delivery, and to place orders, please contact Hittite Microwave Corporation:
20 Alpha Road, Chelmsford, MA 01824 Phone: 978-250-3343 Fax: 978-250-3373
Order On-line at www.hittite.com

Psat vs. Temperature, Vs= 3.6V

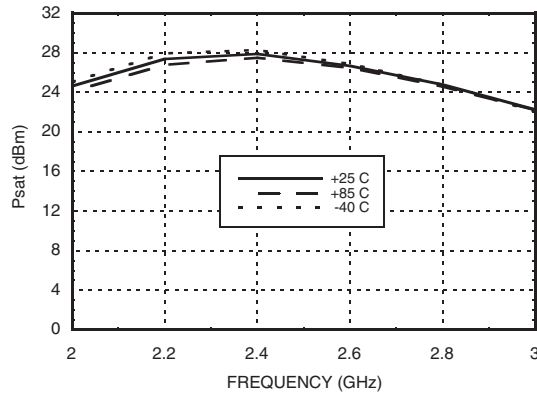

Psat vs. Temperature, Vs= 5V

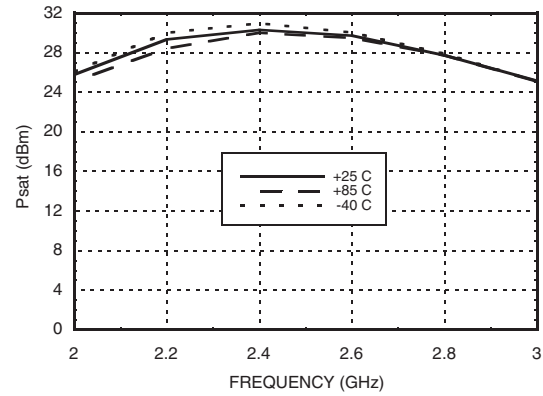

Power Compression@ 2.4 GHz, Vs= 3.6V

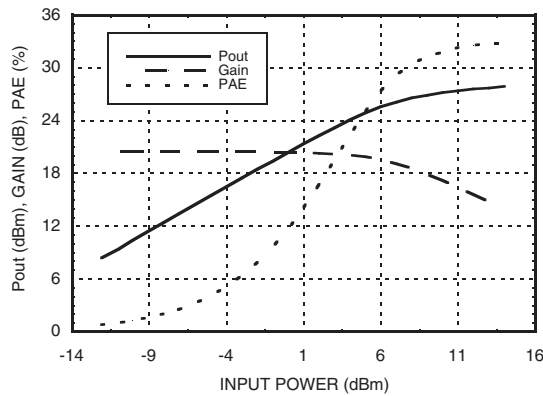

Power Compression@ 2.4 GHz, Vs= 5V

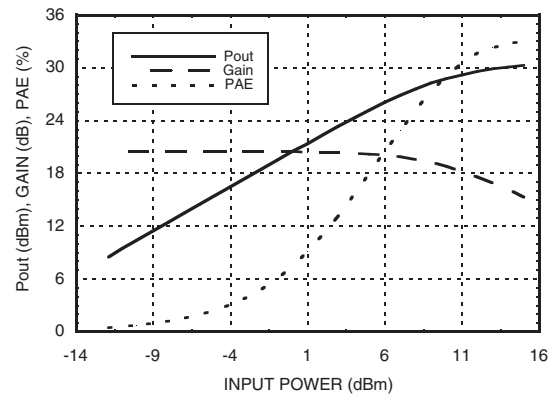

Output IP3 vs. Temperature, Vs= 3.6V

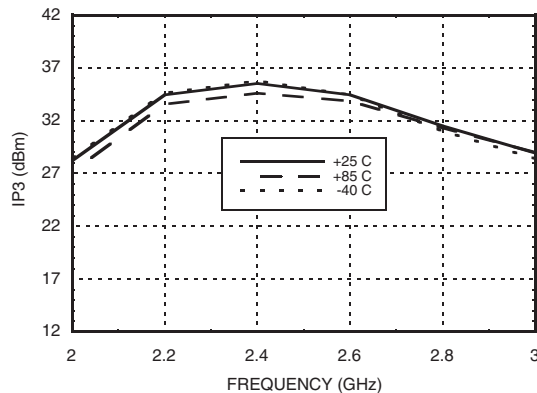

Output IP3 vs. Temperature, Vs= 5V

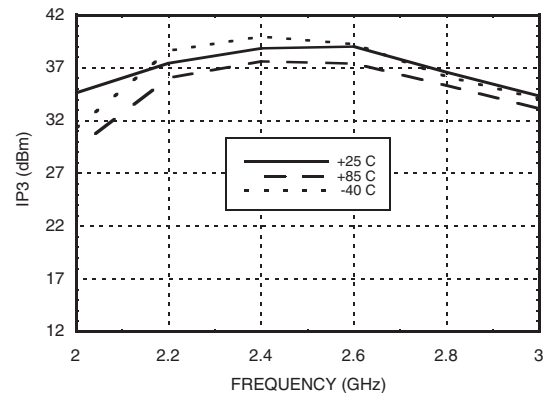



HMC414MS8G / 414MS8GE

GaAs InGaP HBT MMIC POWER AMPLIFIER, 2.2 - 2.8 GHz

Reverse Isolation vs. Temperature, Vs= 3.6V

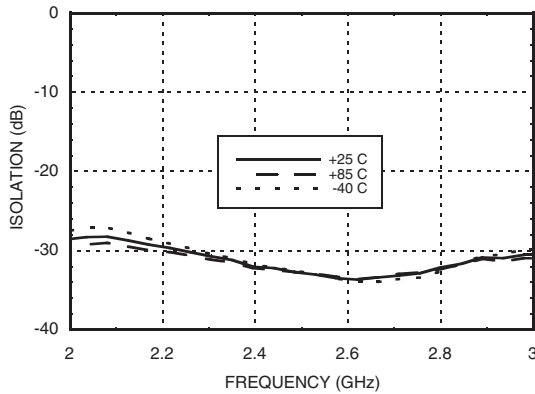

Power Down Isolation, Vs= 3.6V

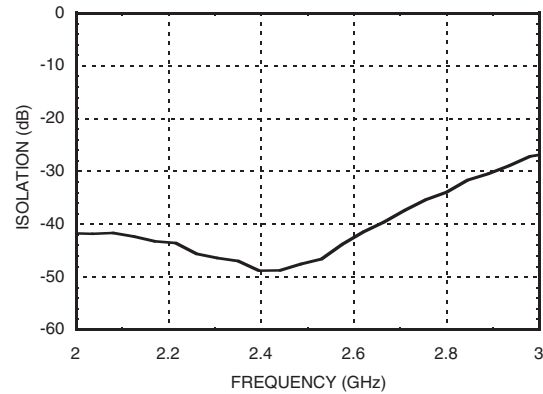

Noise Figure vs. Temperature, Vs= 3.6V

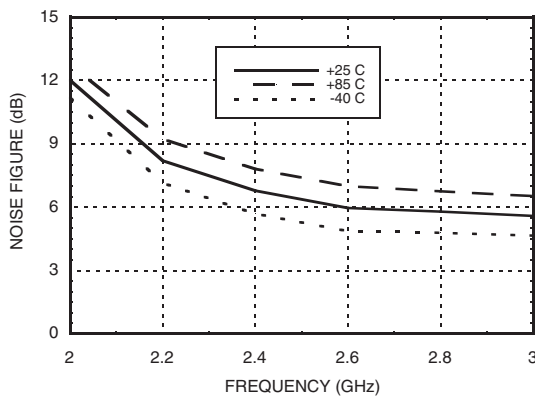

Noise Figure vs. Temperature, Vs= 5V

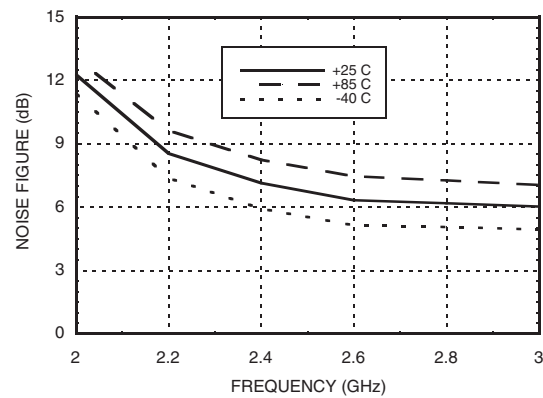

Gain & Power vs. Supply Voltage

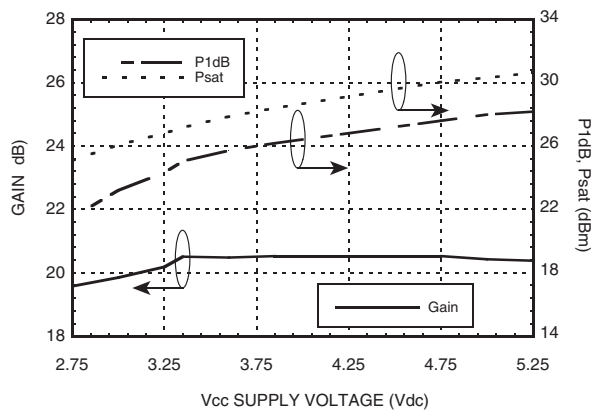

Gain, Power & Quiescent Supply Current vs Vpd@ 2.4 GHz

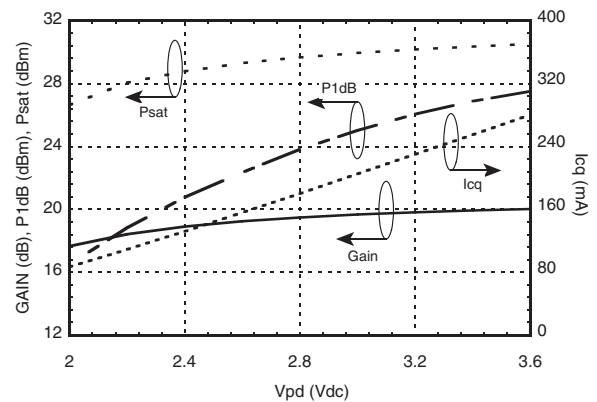

For price, delivery, and to place orders, please contact Hittite Microwave Corporation:
20 Alpha Road, Chelmsford, MA 01824 Phone: 978-250-3343 Fax: 978-250-3373
Order On-line at www.hittite.com

Absolute Maximum Ratings

Collector Bias Voltage (Vcc)	+5.5 Vdc
Control Voltage (Vpd1, Vpd2)	+4.0 Vdc
RF Input Power (RFIN)(Vs = +5.0, Vpd = +3.6 Vdc)	+17 dBm
Junction Temperature	150 °C
Continuous P _{diss} (T = 85 °C) (derate 27 mW/°C above 85 °C)	1.755 W
Thermal Resistance (junction to ground paddle)	37 °C/W
Storage Temperature	-65 to +150 °C
Operating Temperature	-40 to +85 °C



ELECTROSTATIC SENSITIVE DEVICE
OBSERVE HANDLING PRECAUTIONS

Outline Drawing

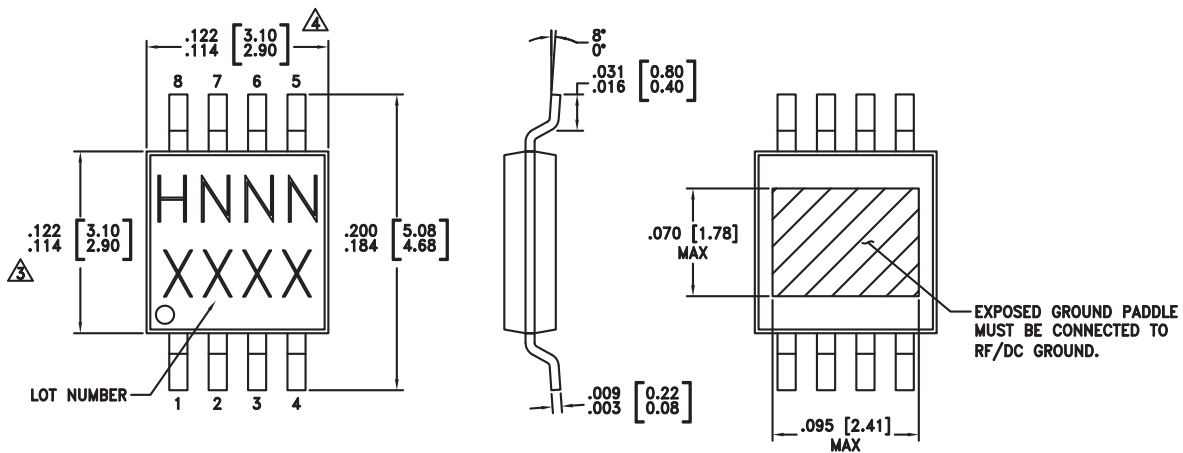

NOTES:

- LEADFRAME MATERIAL: COPPER ALLOY
- DIMENSIONS ARE IN INCHES [MILLIMETERS].
- \triangle DIMENSION DOES NOT INCLUDE MOLDFLASH OF 0.15mm PER SIDE.
- \triangle DIMENSION DOES NOT INCLUDE MOLDFLASH OF 0.25mm PER SIDE.
- ALL GROUND LEADS AND GROUND PADDLE MUST BE SOLDERED TO PCB RF GROUND.

Package Information

Part Number	Package Body Material	Lead Finish	MSL Rating	Package Marking ^[3]
HMC414MS8G	Low Stress Injection Molded Plastic	Sn/Pb Solder	MSL1 ^[1]	H414 XXXX
HMC414MS8GE	RoHS-compliant Low Stress Injection Molded Plastic	100% matte Sn	MSL1 ^[2]	H414 XXXX

[1] Max peak reflow temperature of 235 °C



[2] Max peak reflow temperature of 260 °C

[3] 4-Digit lot number XXXX

For price, delivery, and to place orders, please contact Hittite Microwave Corporation:
20 Alpha Road, Chelmsford, MA 01824 Phone: 978-250-3343 Fax: 978-250-3373
Order On-line at www.hittite.com

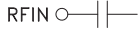
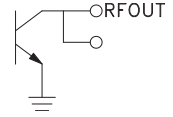

Pin Descriptions

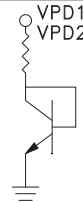
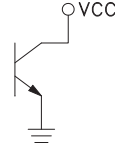
Pin Number	Function	Description	Interface Schematic
1	RFIN	This pin is AC coupled and matched to 50 Ohms.	
2	NC	Not Connected.	
3, 4	RFOUT	RF output and DC bias for the output stage.	
5	GND	Ground: Backside of package has exposed metal ground slug that must be connected to ground thru a short path. Vias under the device are required.	
6, 8	Vpd1, Vpd2	Power control pin. For maximum power, this pin should be connected to 3.6V. For 5V operation, a dropping resistor is required. A higher voltage is not recommended. For lower idle current, this voltage can be reduced.	
7	Vcc	Power supply voltage for the first amplifier stage. An external bypass capacitor of 330 pF is required as shown in the application schematic.	

Evaluation PCB

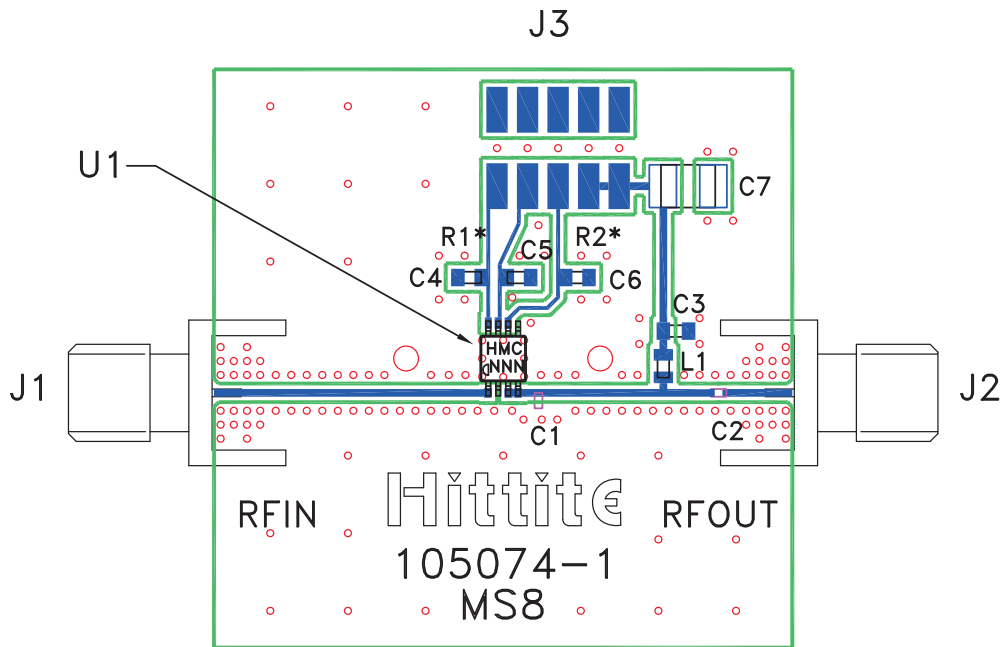

* For 5V operation on Vctl line, select R1, R2 such that 3.6V is presented on Pins 6 and 8.

List of Materials for Evaluation PCB 105006 [1]

Item	Description
J1 - J2	PCB Mount SMA RF Connector
J3	2 mm DC Header
C1	2.7 pF Capacitor, 0603 Pkg.
C2	100 pF Capacitor, 0402 Pkg.
C3 - C6	330 pF Capacitor, 0603 Pkg.
C7	2.2 μF Capacitor, Tantalum
L1	18nH Inductor 0603 Pkg.
U1	HMC414MS8G / HMC414MS8GE Amplifier
PCB [2]	105074 Eval Board

[1] Reference this number when ordering complete evaluation PCB

[2] Circuit Board Material: Rogers 4350

The circuit board used in the final application should use RF circuit design techniques. Signal lines should have 50 ohm impedance while the package ground leads and exposed paddle should be connected directly to the ground plane similar to that shown. A sufficient number of via holes should be used to connect the top and bottom ground planes. The evaluation board should be mounted to an appropriate heat sink. The evaluation circuit board shown is available from Hittite upon request.

Application Circuit

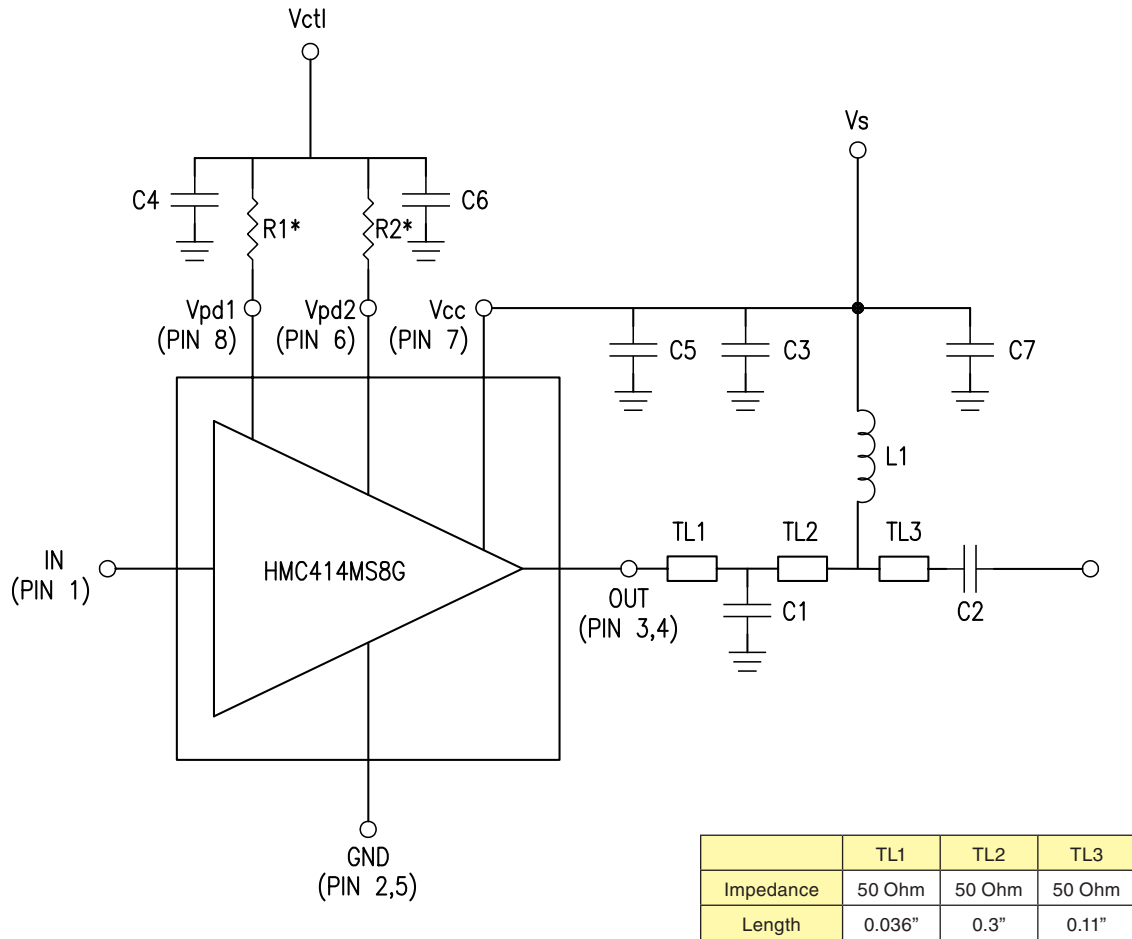

* For 5V operation on Vctl line, select R1, R2 such that 3.6V is presented on Pins 6 and 8.