

## INTRODUCTION

The S1A0900X01 is a monolithic integrated circuit which consists of a 3V one-chip tuner and FM multiplex for AM/FM radios and head-phone radios.

## FUNCTIONS

- FM Stage: RF/IF/AF amp, Quadrature Detector, MIX, OSC, Tuning Indicator.
- AM Stage: RF/IF/AF amp, Detector, MIX, OSC, AGC, Tuning Indicator.
- MPX Stage: PLL amp, Decoder, Flip Flop, VCO Stop, Phase Detector, Stereo Indicator.

## FEATURES

- 3 V one-chip tuner with built-in FM Multiplex
- No AM detect coil, IF coupling capacitor, FM IF by-pass capacitor needed
- Built-in tuning indicator function
- Built-in AM/FM selection switch
- Minimum number of external parts required
- Wide operating voltage range:  $V_{CC} = 1.8V - 7V$
- Low distortion (FM IF: 0.4%, AM IF: 1%, 0.2% (Typ))

## OPDERING INFORMATION

Device	Package	Operature Temperature
S1A0900X01-A0B0	24-SDIP-300	- 20°C - +75°C
S1A0900X01-S0B0	24-SOP-375	

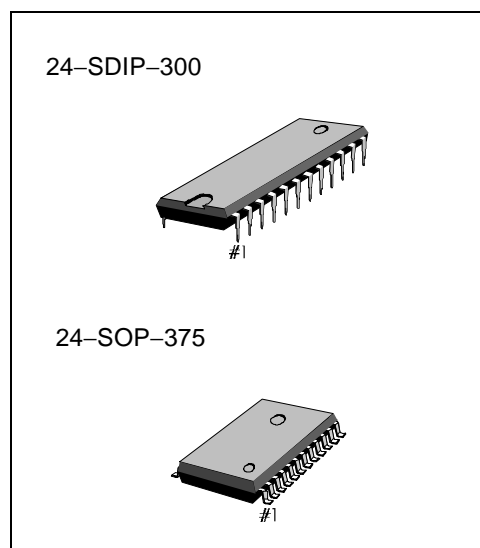

## BLOCK DIAGRAM

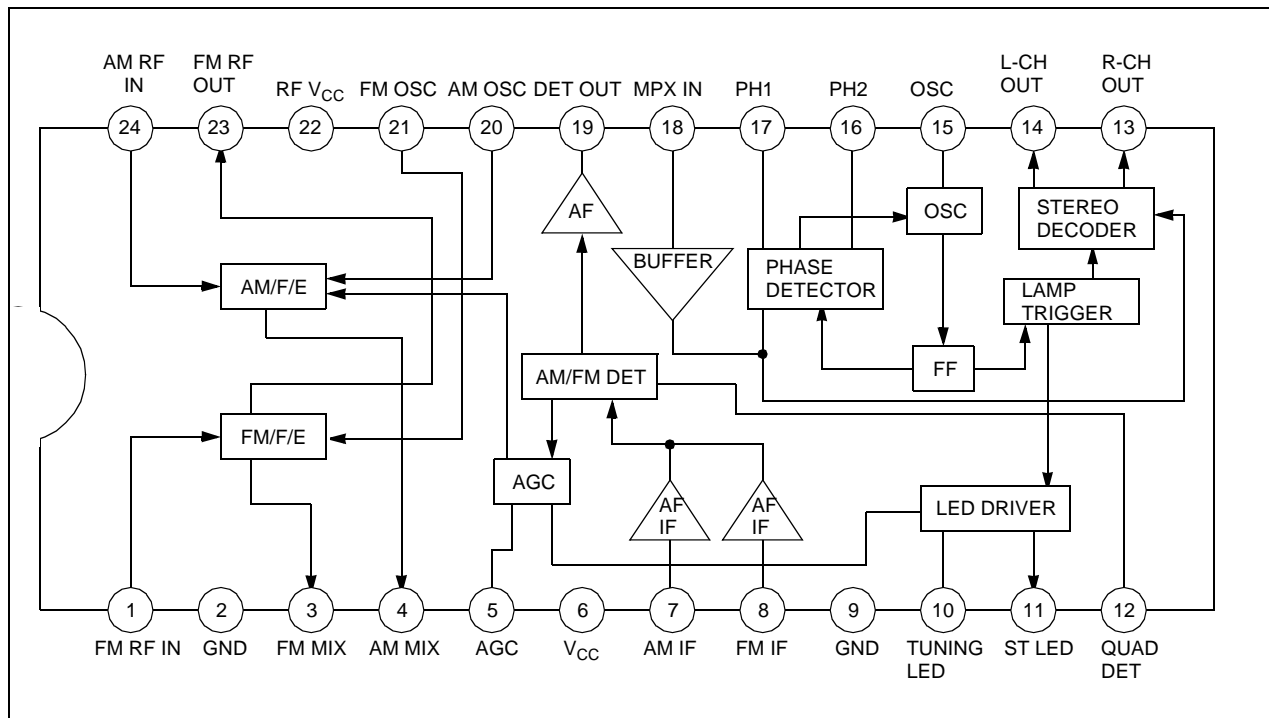

## ABSOLUTE MAXIMUM RATINGS (Ta = 25°C)

Characteristic	Symbol	Value	Unit
Supply Voltage	V <sub>CC</sub>	8	V
Power Dissipation	P <sub>D</sub>	1200	mW
Operating Temperature	T <sub>OPR</sub>	-20 – +75	°C
Storage Temperature	T <sub>STG</sub>	-55 – +150	°C
LED Driver Voltage	V <sub>DR</sub>	10	V
LED Driver Current	I <sub>DR</sub>	10	mA

## ELECTRICAL CHARACTERISTICS

(Ta = 25°C, V<sub>CC</sub> = 3V, unless otherwise specified)

- FM F/E: f = 98MHz, fm = 1kHz, Δf = 22.5kHz, AM: f = 1kHz, 30 % Mod
- FM IF: f = 10.7MHz, fm = 1kHz, Δf = 22.5kHz, MPX: f = 1kHz, L + R = 90 %, P = 10%, V<sub>I</sub> = 150mV

Characteristic		Symbol	Test Conditions	Min.	Typ.	Max.	Unit	Test Circuit
Quiescent Circuit Current		I <sub>CCQ1</sub>	FM, V <sub>I</sub> = 0	8.4	13.2	20.0	mA	1
		I <sub>CCQ2</sub>	AM, V <sub>I</sub> = 0	4.4	8.4	13.4	mA	1
F/E	-3 dB Limiting Sensitivity	V <sub>I(LIM)1</sub>	V <sub>O</sub> = -3dB	-	10	-	dBμ	1
	Oscillation Voltage	V <sub>OSC</sub>	f <sub>OSC</sub> = 98MHz	40	70	110	mV	2
FM IF	-3 dB Limiting Sensitivity	V <sub>I(LIM)2</sub>	V <sub>O</sub> = -3dB	40	46	53	dBμ	1
	Detector Output Voltage	V <sub>O(DET)1</sub>	V <sub>I</sub> = 80dBμ	55	80	110	mV	1
	Signal to Noise Ratio	S/N <sub>1</sub>	V <sub>I</sub> = 80dBμ	60	70	-	dB	1
	Total Harmonic Distortion	THD <sub>1</sub>	V <sub>I</sub> = 80dBμ	-	0.4	1	%	1
	AM Rejection Ratio	AMR	V <sub>I</sub> = 80dBμ	22	32	-	dB	1
	Tuning Indication Voltage	V <sub>L1</sub>	I <sub>LED</sub> = 1mA	45	51	56	dBμ	1
AM IF	Voltage Gain	G <sub>V1</sub>	V <sub>I</sub> = 26dBμ	40	70	110	mV	1
	Detector Output Voltage	V <sub>O(DET)2</sub>	V <sub>I</sub> = 60dBμ	55	80	110	mV	1
	Signal to Noise Ratio	S/N <sub>2</sub>	V <sub>I</sub> = 60dBμ	32	42	-	dB	1
	Total Harmonic Distortion	THD <sub>2</sub>	V <sub>I</sub> = 60dBμ	-	1	2	%	1
	Tuning Indication Voltage	V <sub>L2</sub>	I <sub>LED</sub> = 1mA	20	25	30	dBμ	1

Characteristic		Symbol	Test Conditions	Min.	Typ.	Max.	Unit	Test Circuit
MPX	Maximum Input Voltage	$V_{I(MAX)}$	Stereo, THD = 3%	250	350	–	mV	1
	Channel Separation	$CS_1$	Stereo, f = 100Hz	35	42	–	dB	1
		$CS_2$	Stereo, f = 1kHz	35	42	–	dB	1
		$CS_3$	Stereo, f = 10kHz	35	42	–	dB	1
	Total Harmonic Distortion	$THD_3$	Mono	–	0.2	1	%	1
		$THD_4$	Stereo	–	0.2	1	%	1
	Voltage Gain	$G_{V2}$	Mono	–5	–3	–1	dB	1
	Channel Balance	CB	Mono	–2	0	2	dB	1
	Lamp on Level	$V_{L(ON)}$	Pilot only	–	8	16	mV	1
		$V_{L(OFF)}$	Pilot only	2	6	–	mV	1
	Lamp Hysteresis	HY	–	–	2	–	mV	1
	Capture Range	CR	Pilot only	$\pm 1$	$\pm 3$	$\pm 5$	%	1
	Signal to Noise Ratio	S/N <sub>3</sub>	Mono	60	70	–	dB	1





**COIL SPECIFICATION**

**T1 FM IFT (MIX OUT)**

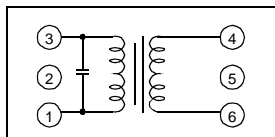

Co(pF)	f (MHz)	Q <sub>o</sub>	TURNS		
			1-3	4-6	
75	10.7	70(min)	11	2	

KOREA TOKO  
0.1 mmφ

**T2 AM IFT (MIX OUT)**

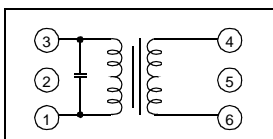

Co(pF)	f (MHz)	Q <sub>o</sub>	TURNS		
			1-3	4-6	
180	455	70(min)	180	15	

KOREA TOKO  
0.08 mmφ

**T3 FM IFT (DET)**

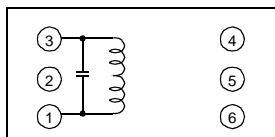

Co(pF)	f (MHz)	Q <sub>o</sub>	TURNS		
			1-3		
47	10.7	80(min)	14		

KOREA TOKO  
0.1 mmφ

**L1 FM RF**

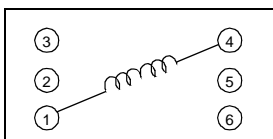

f (MHz)	Q <sub>o</sub>	TURNS		
		1-3		
100	100	2*(1/2)		

0.5 mmφ

**L2 FM OSC**

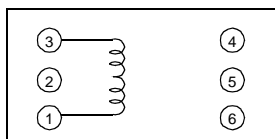

f (MHz)	Q <sub>o</sub>	TURNS		
		1-3		
100	100	2*(3/4)		

0.5 mmφ

**L3 AM OSC**

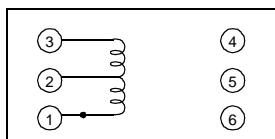

f (KHz)	Q <sub>o</sub>	TURNS		L (μH)
		1-2	2-3	
796	80(min)	13	15	288

KOREA TOKO  
0.08 mmφ

T1 FM IFT (MIX OUT)

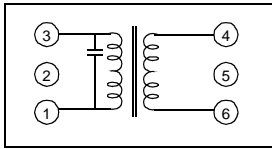

KSI-FA2

Co(pF)	F (MHz)	Qo	TURNS		KWANG SUNG PART NO
			1-3	4-6	
75	10.7	70(min)	11	2	KSI-FA2

T2 AM IFT (MIX OUT)

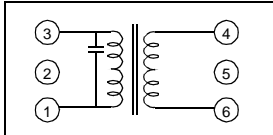

KSI-AA1

Co(pF)	F (MHz)	Qo	TURNS		KWANG SUNG PART NO
			1-3	4-6	
180	455	70(min)	146	14	KSI-AA1

T3 FM IFT (DET)

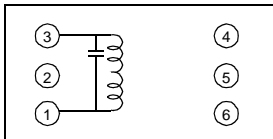

KSI-FD3

Co (pF)	F (MHz)	Qo	TURNS	KWANG SUNG PART NO
			1-3	
47	10.7	80(min)	14	KSI-FD3

L1 FM RF

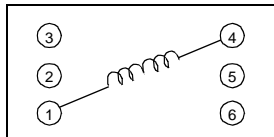

KST-FR1

F (MHz)	Qo	TURNS		KWANG SUNG PART NO
		1-3	WIRE	
100	100	2*(1/2)	0.5m/m	KST-FR1

L2 FM OSC

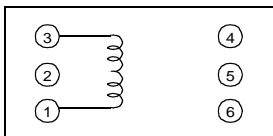

KST-FO1

F (MHz)	Qo	TURNS		KWANG SUNG PART NO
		1-3	WIRE	
100	100	2*(3/4)	0.5m/m	KST-AO1

L3 AM OSC

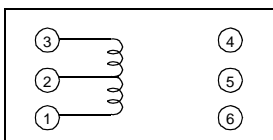

KSI-AO1

F (MHz)	Qo	TURNS		L (uH)	KWANG SUNG PART NO
		1-2	2-3		
796	80min	13	73	288	KSI-AO1



APPLICATION CIRCUIT

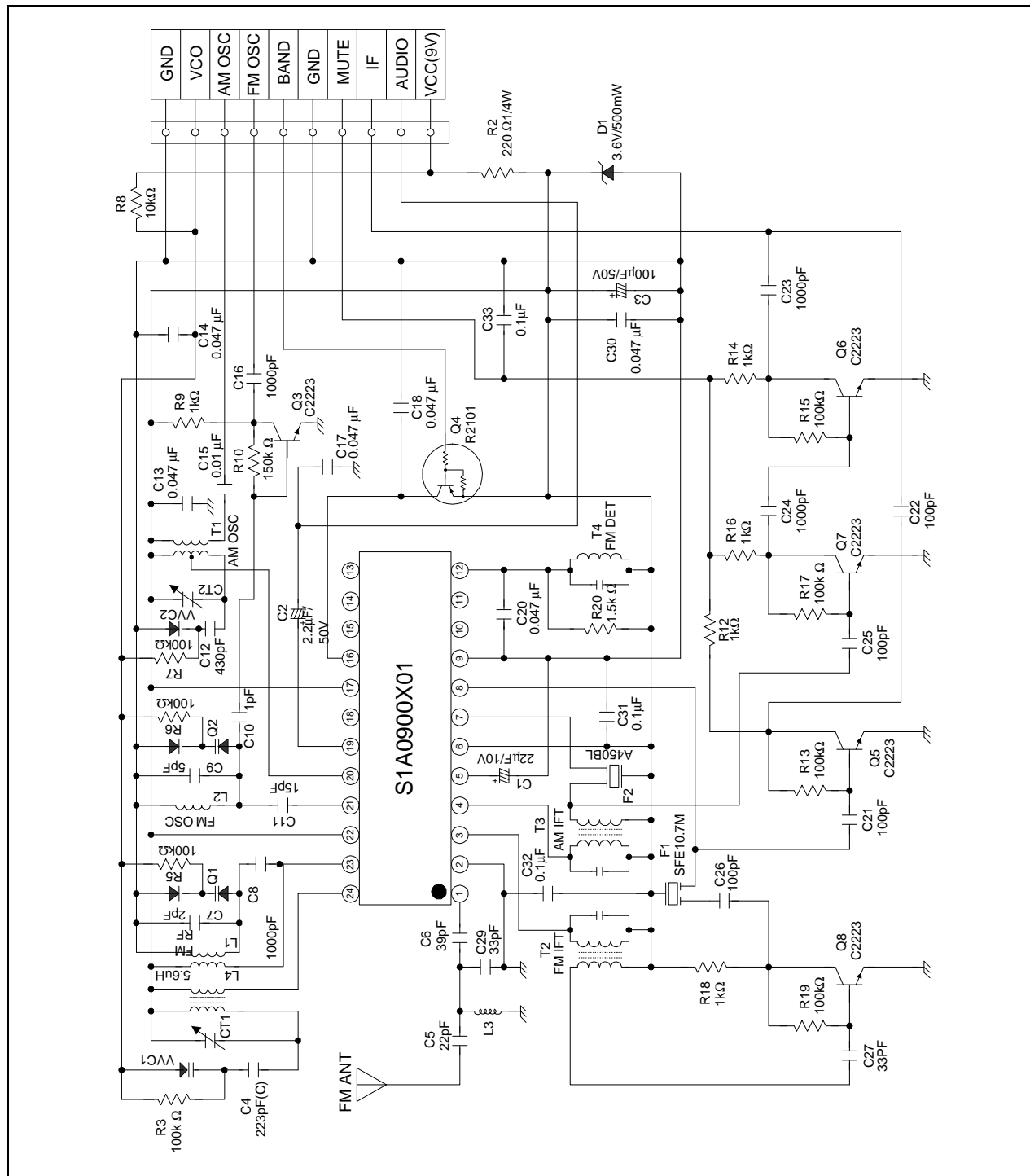

NOTES