

Typical Applications

The HMC270MS8G / HMC270MS8GE is ideal for DC - 8.0 GHz applications:

- CATV
- MMDS & WirelessLAN
- Wireless Local Loop

Features

- Broadband Performance: DC - 8 GHz
- Very High Isolation: 45 dB @ 6 GHz
- Non-Reflective Design
- Low Cost MSOP-8 Package: 14.8 mm²

Functional Diagram

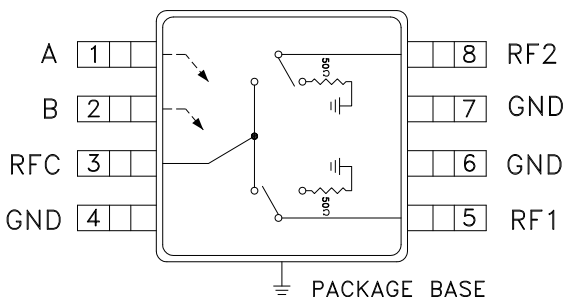

General Description

The HMC270MS8G & HMC270MS8GE are broadband non-reflective GaAs SPDT switches in 8 lead MSOP grounded base surface mount plastic packages. Covering DC to 8 GHz, the switch offers excellent isolation from 70 to 35 dB. The negative control voltage of -5 volts allows operation down to DC. If positive control is required along with high isolation, see the DC to 3.5 GHz HMC284MS8G non-reflective SPDT.

Electrical Specifications, $T_A = +25^\circ\text{C}$, With 0/-5V Control, 50 Ohm system

Parameter	Frequency	Min.	Typ.	Max.	Units
Insertion Loss	DC - 2.0 GHz		0.8	1.2	dB
	DC - 6.0 GHz		1.0	1.7	dB
	DC - 8.0 GHz		1.5	2.4	dB
Isolation	DC - 2.0 GHz	43	48		dB
	DC - 4.0 GHz	42	47		dB
	DC - 6.0 GHz	37	45		dB
	DC - 8.0 GHz	28	33		dB
Return Loss	DC - 2.0 GHz	11	14		dB
	DC - 6.0 GHz	9	12		dB
	DC - 8.0 GHz	7	10		dB
Return Loss RF1, RF2	DC - 2.0 GHz	15	20		dB
	DC - 6.0 GHz	13	18		dB
	DC - 8.0 GHz	10	15		dB
Input Power for 1 dB Compression	0.5 - 8.0 GHz	20	23		dBm
Input third Order Intercept (Two-Tone Input Power = +7 dBm Each Tone)	0.5 - 8.0 GHz	33	36		dBm
Switching Characteristics	DC - 8.0 GHz				
		tRISE, tFALL (10/90% RF)		20	ns
		tON, tOFF (50% CTL to 10/90% RF)		50	ns

For price, delivery, and to place orders, please contact Hittite Microwave Corporation:
20 Alpha Road, Chelmsford, MA 01824 Phone: 978-250-3343 Fax: 978-250-3373
Order On-line at www.hittite.com

Insertion Loss

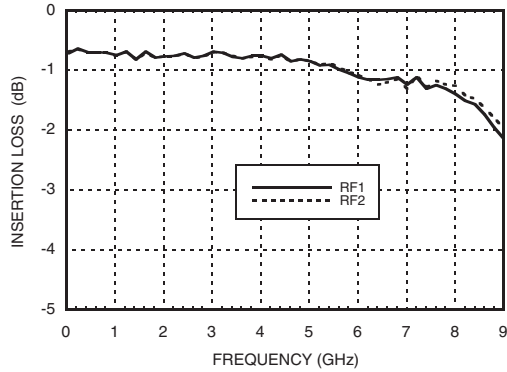

Isolation

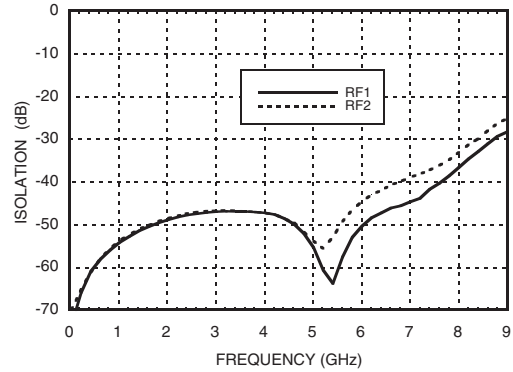

Return Loss

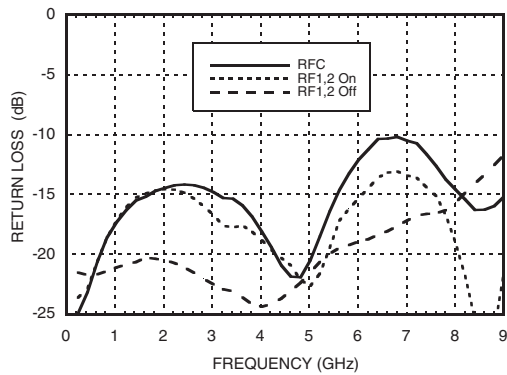

0.1 and 1 dB Input Compression Point

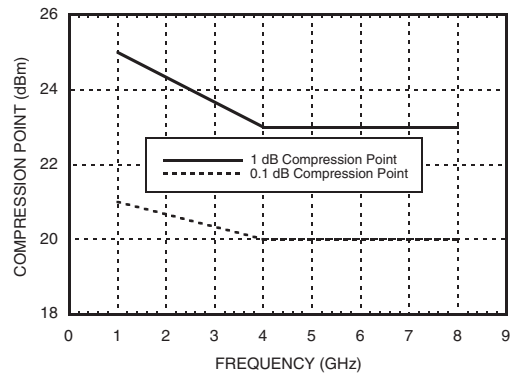

Input Third Order Intercept Point

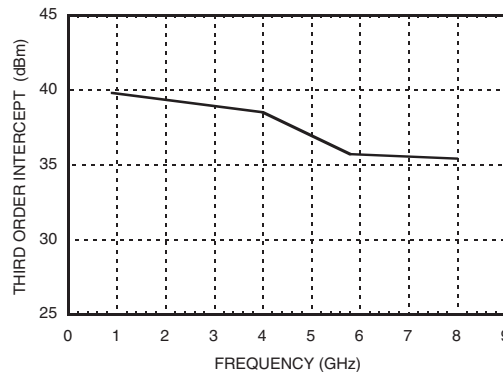

For price, delivery, and to place orders, please contact Hittite Microwave Corporation:
20 Alpha Road, Chelmsford, MA 01824 Phone: 978-250-3343 Fax: 978-250-3373
Order On-line at www.hittite.com



GaAs MMIC SPDT SWITCH NON-REFLECTIVE, DC - 8 GHz

Control Voltages

State	Bias Condition
Low	0 to -0.2V @ 10 uA Typ.
High	-5V @ 35 uA Typ. to -7V @ 100 uA Typ (± 0.5 Vdc)

RFC, RF1, & RF2 should be at <100 mV DC potential. Otherwise, DC blocking capacitors are recommended. Choose value for lowest frequency of operation.

Do not "HOT" switch power levels >+13 dBm
(Vctl = 0/-5Vdc)

Truth Table

Control Input		Signal Path State	
A	B	RFC to RF1	RFC to RF2
High	Low	ON	OFF
Low	High	OFF	ON

Absolute Maximum Ratings

Max RF Input Power, Vctl = -5V	+24 dBm
Control Voltage Range	+0.5 to -7.5 Vdc
Storage Temperature	-65 to +150 °C
Operating Temperature	-40 to +85 °C
ESD Sensitivity (HBM)	Class 1A



ELECTROSTATIC SENSITIVE DEVICE
OBSERVE HANDLING PRECAUTIONS

Outline Drawing

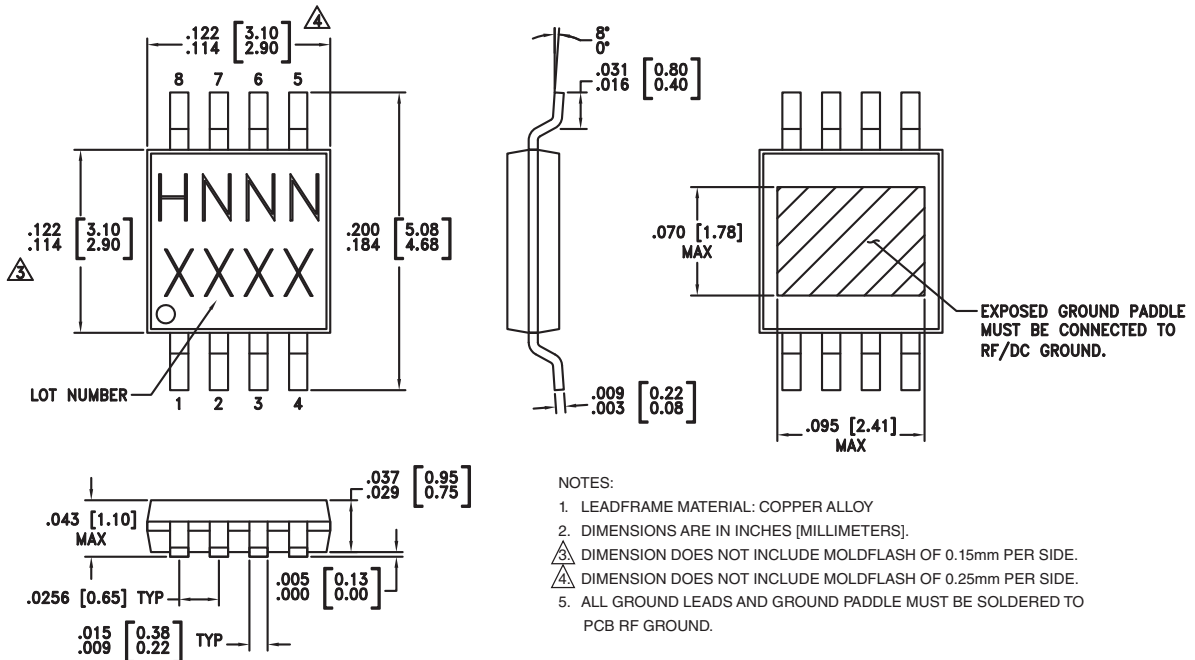

Package Information

Part Number	Package Body Material	Lead Finish	MSL Rating	Package Marking [3]
HMC70MS8G	Low Stress Injection Molded Plastic	Sn/Pb Solder	MSL1 [1]	H270 XXXX
HMC270MS8GE	RoHS-compliant Low Stress Injection Molded Plastic	100% matte Sn	MSL1 [2]	H270 XXXX

[1] Max peak reflow temperature of 235 °C

[2] Max peak reflow temperature of 260 °C

[3] 4-Digit lot number XXXX

For price, delivery, and to place orders, please contact Hittite Microwave Corporation:
20 Alpha Road, Chelmsford, MA 01824 Phone: 978-250-3343 Fax: 978-250-3373
Order On-line at www.hittite.com

Suggested Driver Circuit for HMC270MS8G

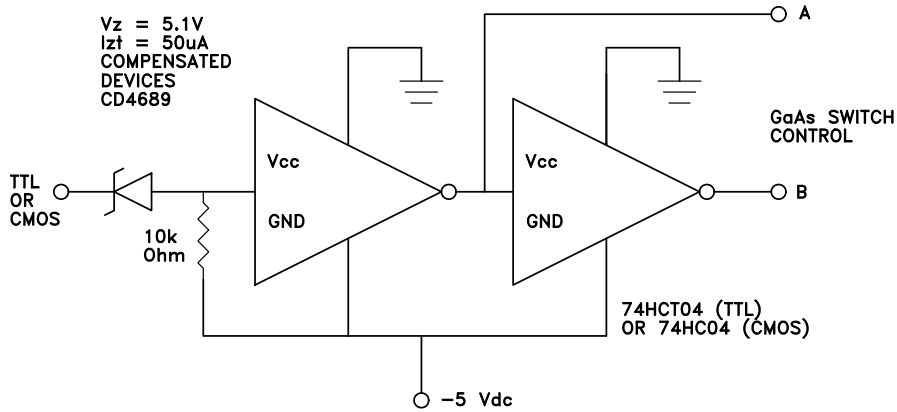

Simple driver using inexpensive standard logic ICs provides fast switching using minimum DC current while translating from standard positive voltage TTL or CMOS logic to negative voltage GaAs IC logic.

Eval Board Layout (Top View)

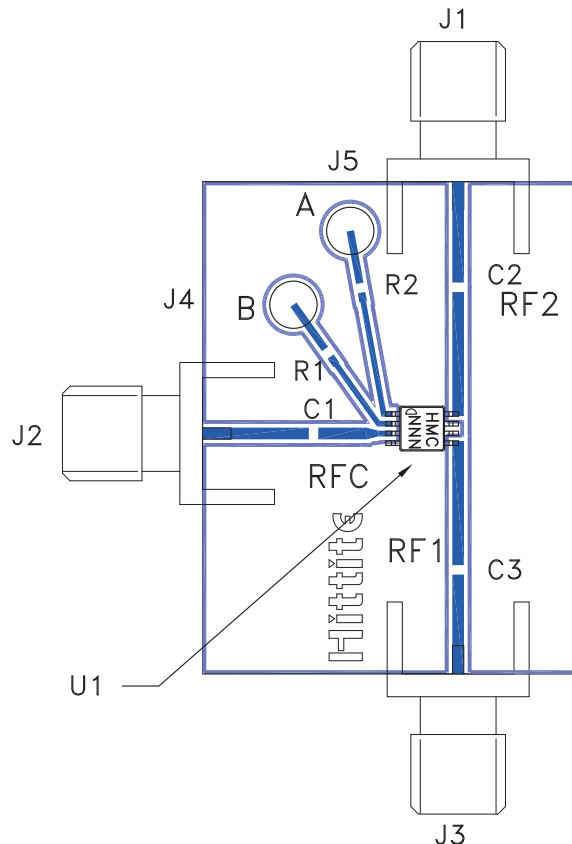

*R1 = R2 = 100 Ohm.
These are optional resistors.

List of Materials for Evaluation PCB 107949 [1]

Item	Description
J1 - J3	PCB Mount SMA Connector
J4 - J5	DC Pin
C1 - C3	Chip Capacitor, 0402 Pkg, choose value for lowest frequency of operation. PCBs are provided with 100 ~ 300 pF capacitors. User may jumper capacitor mounting gaps on PCB to allow operation to "DC".
R1 - R2	100 Ohm Resistor, 0402 Pkg.
U1	HMC270MS8G / HMC270MS8GE SPDT Switch
PCB [2]	102807 Evaluation PCB 2.0" x 2.6"

[1] Reference this number when ordering complete evaluation PCB

[2] Circuit Board Material: Rogers 4350

The circuit board used in the final application should be generated with proper RF circuit design techniques. Signal lines at the RF ports should have 50 ohm impedance and the package ground leads and exposed ground paddle should be connected directly to the ground plane similar to that shown above. The evaluation circuit board shown above is available from Hittite Microwave Corporation upon request.

For price, delivery, and to place orders, please contact Hittite Microwave Corporation:
20 Alpha Road, Chelmsford, MA 01824 Phone: 978-250-3343 Fax: 978-250-3373
Order On-line at www.hittite.com