

# SMD Power Inductor CDRH10D38D

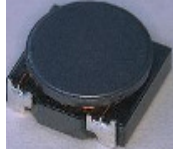

RoHS

Halogen  
Free



## Description

- Ferrite drum core construction.
- Magnetically shielded.
- L × W × H: 10.3 × 10.3 × 4.0 mm Max.
- Product weight: 1.35g(Ref.)
- Moisture Sensitivity Level: 1
- RoHS compliance.
- Halogen Free available.

## Environmental Data

- Operating temperature range: -40°C~+105°C (including coil's self temperature rise)
- Storage temperature range: -40°C~+105°C
- Solder reflow temperature: 260 °C peak.

## Packaging

- Carrier tape and reel packaging

## Applications

- Ideally used in LCD TV and Note PC.

## Dimension - [mm]

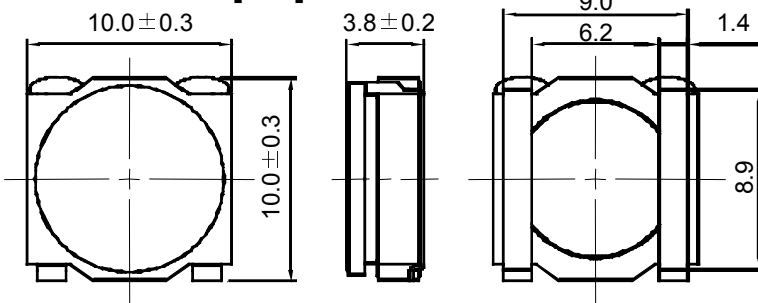

## Land pattern and Schematics - [mm]

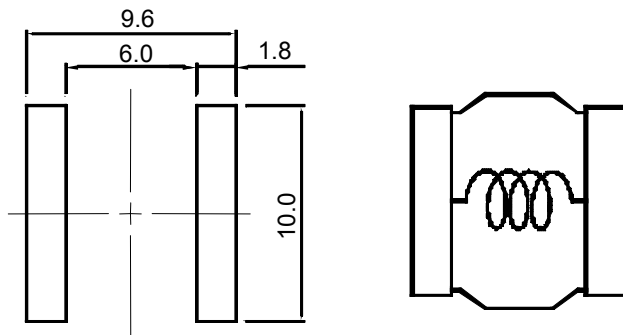



### Electrical Characteristics

PART NAME	STAMP	INDUCTANCE [WITHIN] (100kHz)	D.C.R. (mΩ) (at 20°C)	SATURATION CURRENT(A)※1 (at 20°C)	TEMPERATURE RISE CURRENT(A)※2
CDRH10D38DNP-R82PC	R82	0.82 ± 25%	3.5 ± 25%	12.90	12.70
CDRH10D38DNP-1R5PC	1R5	1.5 ± 25%	5.0 ± 25%	9.50	11.20
CDRH10D38DNP-2R2PC	2R2	2.2 ± 25%	7.0 ± 25%	7.80	9.30
CDRH10D38DNP-3R3PC	3R3	3.3 ± 25%	9.0 ± 25%	6.45	7.90
CDRH10D38DNP-4R7PC	4R7	4.7 ± 25%	11.0 ± 25%	5.45	7.50
CDRH10D38DNP-6R2MC	6R2	6.2 ± 20%	15.5 ± 25%	4.70	5.95
CDRH10D38DNP-100MC	100	10 ± 20%	22.5 ± 25%	3.55	4.85
CDRH10D38DNP-150MC	150	15 ± 20%	35.5 ± 25%	3.00	3.70
CDRH10D38DNP-220MC	220	22 ± 20%	57 ± 25%	2.45	2.85
CDRH10D38DNP-330MC	330	33 ± 20%	71 ± 25%	2.00	2.65
CDRH10D38DNP-470MC	470	47 ± 20%	100 ± 20%	1.65	2.25
CDRH10D38DNP-680MC	680	68 ± 20%	152 ± 20%	1.40	1.74
CDRH10D38DNP-101MC	101	100 ± 20%	232 ± 20%	1.15	1.38
CDRH10D38DNP-151MC	151	150 ± 20%	355 ± 20%	0.95	1.03
CDRH10D38DNP-221MC	221	220 ± 20%	465 ± 20%	0.75	0.95
CDRH10D38DNP-331MC	331	330 ± 20%	710 ± 20%	0.65	0.76
CDRH10D38DNP-471MC	471	470 ± 20%	1065 ± 20%	0.55	0.65

※1. Saturation current: The value of D.C. current when the inductance decreases to 70% of it's nominal value.

※2. Temperature rise current: The value of D.C. current when the temperature rise is  $\Delta t = 40^\circ\text{C}$  ( $T_a = 20^\circ\text{C}$ ).

# SMD Power Inductor CDRH10D38D



## Saturation Current & Temperature Rise Graph

— L (20°C) — L (105°C) —  $\Delta T$

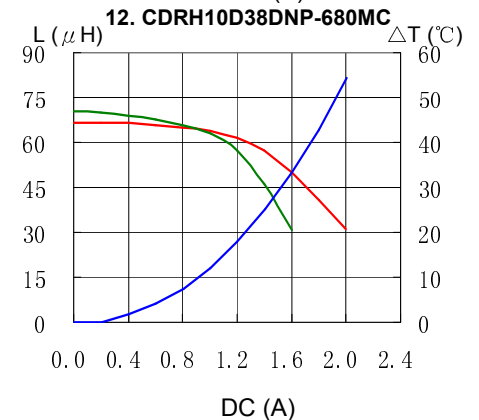
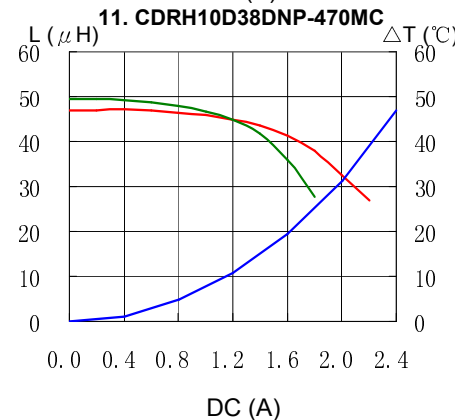
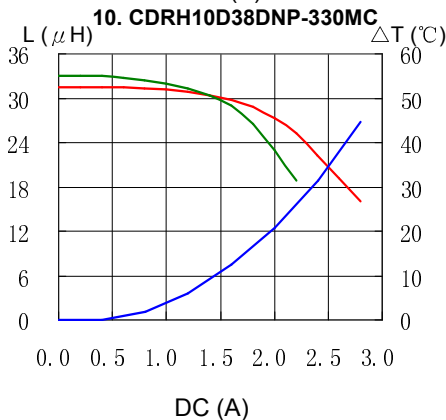
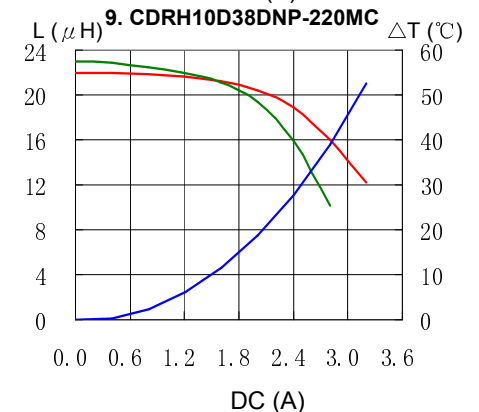
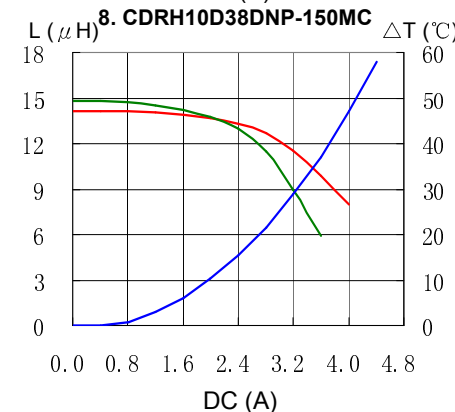
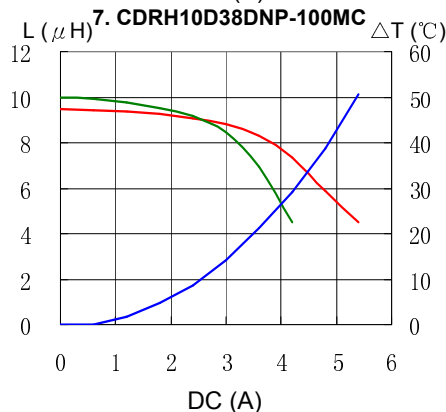
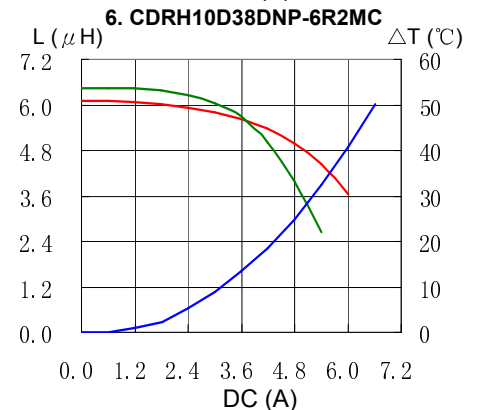
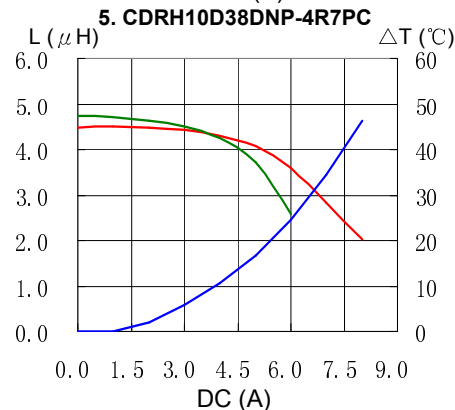
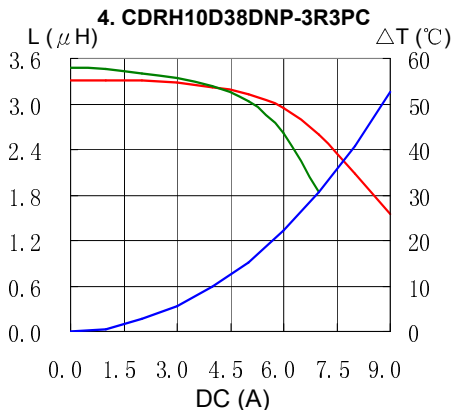
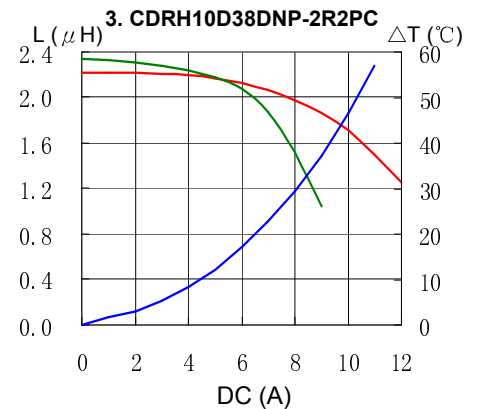
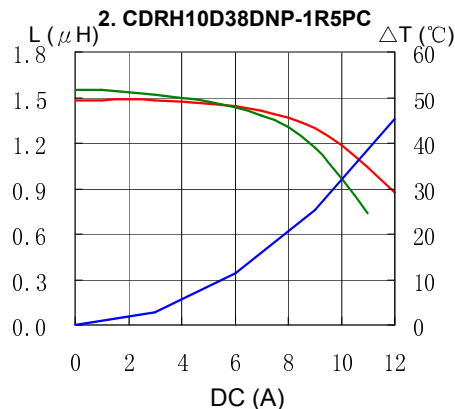
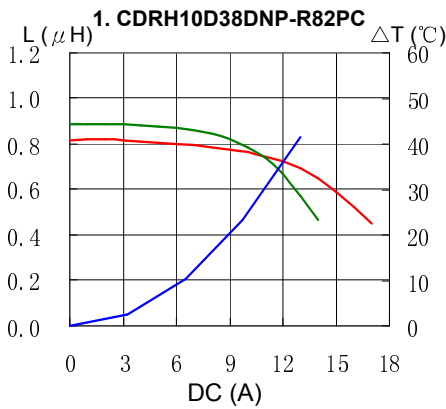

# SMD Power Inductor CDRH10D38D



## Saturation Current & Temperature Rise Graph

— L (20°C) — L (105°C) —  $\Delta T$

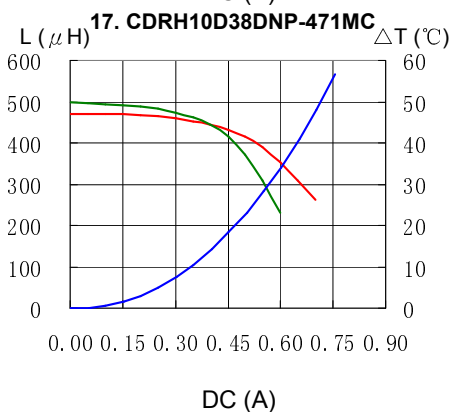
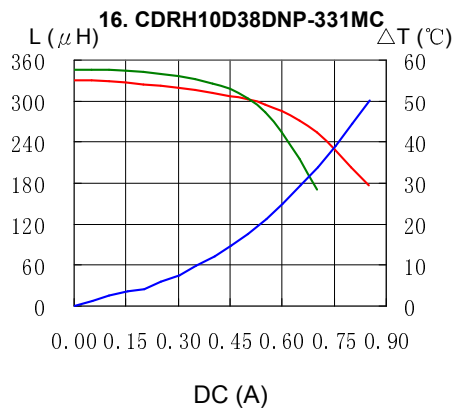
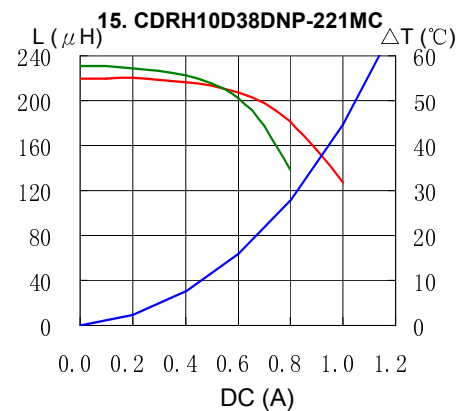
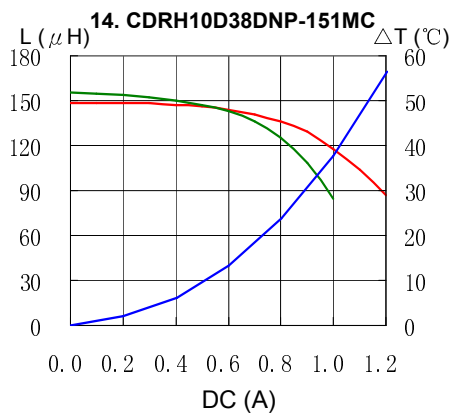
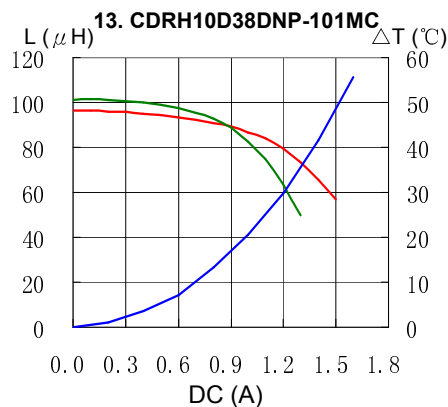

## Solder Reflow Condition

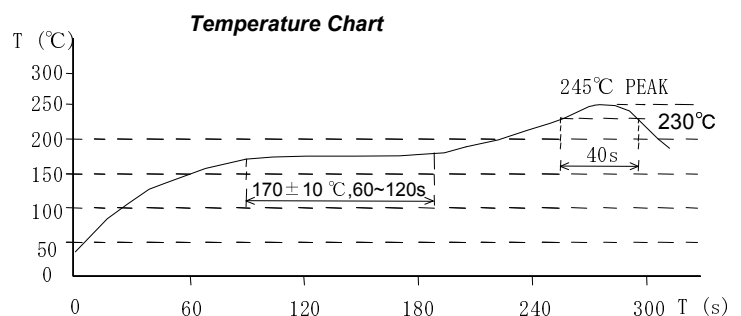
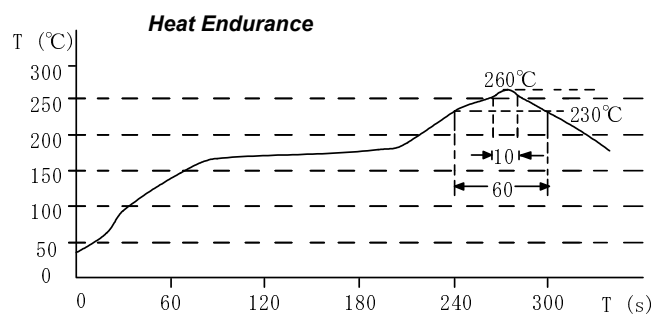

Please refer to the sales offices on our website - <http://www.sumida.com>

**Hong Kong**  
Tel. +852-2880-6688  
FAX. +852-2565-9600  
[sales@hk.sumida.com](mailto:sales@hk.sumida.com)

**Tokyo**  
Tel. +81-3-5202-7112  
FAX. +81-3-5202-7105  
[sales@jp.sumida.com](mailto:sales@jp.sumida.com)

**Chicago**  
Tel. +1-847-545-6700  
FAX. +1-847-545-6720  
[sales@us.sumida.com](mailto:sales@us.sumida.com)

**Shanghai**  
Tel. +86-021-5836-3299  
FAX. +86-021-5836-3266  
[shanghai.sales@cn.sumida.com](mailto:shanghai.sales@cn.sumida.com)

**Seoul**  
Tel. +82-2-6237-0777  
FAX. +82-2-6237-0778  
[sales@kr.sumida.com](mailto:sales@kr.sumida.com)

**Oberzell**  
Tel. +49-8591-937-0  
FAX. +49-8591-937-103  
[contact@sumida-eu.com](mailto:contact@sumida-eu.com)

**Shenzhen**  
Tel. +86-755-8291-0228  
FAX. +86-755-8291-0338  
[shenzhen.sales@cn.sumida.com](mailto:shenzhen.sales@cn.sumida.com)

**Singapore**  
Tel. +65-6296-3388  
FAX. +65-6296-3390  
[sales@sg.sumida.com](mailto:sales@sg.sumida.com)

**Neumarkt**  
Tel. +49-9181-4509-110  
FAX. +49-9181-4509-310  
[infocomp@eu.sumida.com](mailto:infocomp@eu.sumida.com)

**Taipei**  
Tel. +886-2-8751-2737  
FAX. +886-2-8751-2738  
[sales@tw.sumida.com](mailto:sales@tw.sumida.com)

**San Jose**  
Tel. +1-408-3219660  
FAX. +1-408-321-9308  
[sales@us.sumida.com](mailto:sales@us.sumida.com)