

Pinouts

Figure 1. Pin Diagram - 8 Pin SOIC/TSSOP

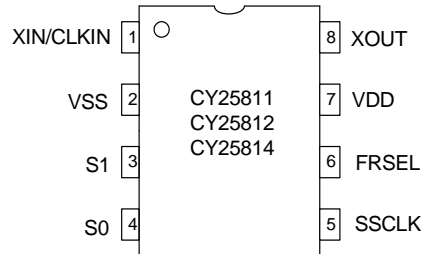

Table 1. Pin Definition - 8 Pin SOIC/TSSOP

Pin No.	Name	Type	Description
1	Xin/CLK		Crystal, ceramic resonator or clock input pin
2	VSS		Power supply ground.
3	S1		Digital Spread% control pin. 3-Level input (H-M-L). Default = M.
4	S0		Digital Spread% control pin. 3-Level input (H-M-L). Default = M.
5	SSCLK		Spread Spectrum output clock.
6	FRSEL		Input frequency range selection digital control input. 3-Level input (H-M-L). Default = M.
7	VDD		Positive power supply.
8	XOUT		Crystal or ceramic resonator output pin.

Functional Description

The CY25811/12/14 products are Spread Spectrum Clock Generator (SSCG) ICs used for the purpose of reducing electromagnetic interference (EMI) found in today's high speed digital electronic systems.

The devices use a Cypress proprietary phase-locked loop (PLL) and Spread Spectrum Clock (SSC) technology to synthesize and modulate the frequency of the input clock. By frequency modulating the clock, the measured EMI at the fundamental and harmonic frequencies is greatly reduced.

This reduction in radiated energy significantly reduces the cost of complying with regulatory agency requirements and improves time to market without degrading system performance.

The input frequency range is 4 to 32 MHz and accepts clock, crystal and ceramic resonator inputs. The output clock can be selected to produce 1x, 2x, or 4x multiplication of the input frequency with Spread Spectrum Frequency Modulation.

The use of 2x or 4x frequency multiplication eliminates the need for higher order crystals and enables the user to generate up to 128 MHz Spread Spectrum Clock (SSC) by using only first order crystals. This reduces the cost while improving the system clock accuracy, performance, and complexity.

The user selects Center Spread or Down Spread frequency modulation based on four discrete values of Spread % for each Spread mode with the option of a Non Spread mode for system test and verification purposes.

The CY25811/12/14 products are available in an 8 pin SOIC -150 mil package with a commercial operating temperature range of 0 to 70°C and Industrial Temperature range of -40 to 85°C. Refer to CY25568 for multiple clock output options such as modulated and unmodulated clock outputs or Power-down function. For Automotive applications, refer to CY25811/12/14SE data sheets.

Input Frequency Range and Selection

The CY25811/12/14 input frequency range is 4 to 32 MHz. This range is divided into three segments and controlled by a 3-Level FRSEL pin as given in Table 2.

Table 2. Input Frequency Selection

FRSEL	Input Frequency Range
0	4.0 to 8.0 MHz
1	8.0 to 16.0 MHz
M	16.0 to 32.0 MHz

Spread Percentage Selection

The CY25811/12/14 SSCG products provide Center-Spread, Down-Spread, and No-Spread functions. The amount of Spread percentage is selected using 3-Level. S0 and S1 digital inputs and Spread percent values are given in [Table 3](#).

Table 3. Spread Percent Selection

XIN (MHz)	FRSEL	S1 = 0 S0 = 0	S1 = 0 S0 = M	S1 = 0 S0 = 1	S1 = M S0 = 0	S1 = 1 S0 = 1	S1 = 1 S0 = 0	S1 = M S0 = 1	S1 = 1 S0 = M	S1 = M S0 = M
		Center (%)	Center (%)	Center (%)	Center (%)	Down (%)	Down (%)	Down (%)	Down (%)	No Spread
4-5	0	±1.4	±1.2	±0.6	±0.5	-3.0	-2.2	-1.9	-0.7	0
5-6	0	±1.3	±1.1	±0.5	±0.4	-2.7	-1.9	-1.7	-0.6	0
6-7	0	±1.2	±0.9	±0.5	±0.4	-2.5	-1.8	-1.5	-0.6	0
7-8	0	±1.1	±0.9	±0.4	±0.3	-2.3	-1.7	-1.4	-0.5	0
8-10	1	±1.4	±1.2	±0.6	±0.5	-3.0	-2.2	-1.9	-0.7	0
10-12	1	±1.3	±1.1	±0.5	±0.4	-2.7	-1.9	-1.7	-0.6	0
12-14	1	±1.2	±0.9	±0.5	±0.4	-2.5	-1.8	-1.5	-0.6	0
14-16	1	±1.1	±0.9	±0.4	±0.3	-2.3	-1.7	-1.4	-0.5	0
16-20	M	±1.4	±1.2	±0.6	±0.5	-3.0	-2.2	-1.9	-0.7	0
20-24	M	±1.3	±1.1	±0.5	±0.4	-2.7	-1.9	-1.7	-0.6	0
24-28	M	±1.2	±0.9	±0.5	±0.4	-2.5	-1.8	-1.5	-0.6	0
28-32	M	±1.1	±0.9	±0.4	±0.3	-2.3	-1.7	-1.4	-0.5	0

3-Level Digital Inputs

S0, S1, and FRSEL digital inputs are designed to sense 3 different logic levels designated as High “1”, Low “0”, and Middle “M”. With this 3-Level digital input logic, the 3-Level Logic detects nine different logic states.

S0, S1, and FRSEL pins include an on chip 20K (10K and 10K) resistor divider. No external application resistors are needed to implement the 3-Level logic levels as shown here:

Logic Level “0”: 3-Level logic pin connected to GND.

Logic Level “M”: 3-Level logic pin left floating (no connection).

Logic Level “1”: 3-Level logic pin connected to V_{DD}.

[Figure 2](#) illustrates how to implement 3-Level Logic.

Figure 2. 3-Level Logic

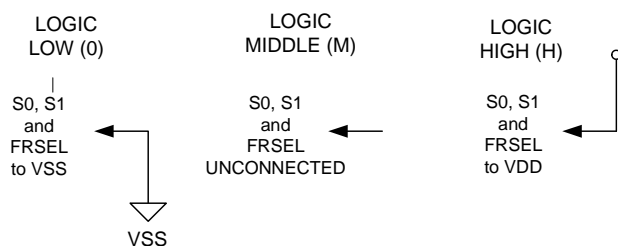

Modulation Rate

SSCGs use frequency modulation (FM) to distribute energy over a specific band of frequencies. The maximum frequency of the clock (f_{max}), and minimum frequency of the clock (f_{min}) determine this band of frequencies. The time required to transition from f_{min} to f_{max} and back to f_{min} is the period of the Modulation Rate. The Modulation Rate of SSCG clocks are generally referred to in terms of frequency, or:

$$f_{mod} = 1/T_{mod}$$

The input clock frequency, f_{in}, and the internal divider determine the Modulation Rate.

In CY25811/2/4 devices, the (Spread Spectrum) modulation Rate, f_{mod}, is given by the following formula:

$$f_{mod} = f_{in}/DR$$

Here f_{mod} is the Modulation Rate, f_{in} is the Input Frequency, and DR is the Divider Ratio as given in [Table 4](#). Note that Input Frequency Range is set by FRSEL.

Table 4. Modulation Rate Divider Ratios

FRSEL	Input Frequency Range (MHz)	Divider Ratio (DR)
0	4 to 8	128
1	8 to 16	256
M	16 to 32	512

Input and Output Frequency Selection

The relationship between input frequency and output frequency in device selection and FRSEL setting is given in [Table 5](#). As shown, the input frequency range is selected by FRSEL and is the same for CY25811, CY25812, and CY25814. The selection of CY25811 (1x), CY25812 (2x), or CY25814 (4x) determines the frequency multiplication at the output (SSCLK, Pin 5) with respect to input frequency (XIN, Pin-1).

Table 5. Input and Output Frequency Selection

Input Frequency Range (MHz)	FRSEL	Product	Multiplication	Output Frequency Range (MHz)
4 to 8	0	CY25811	1x	4 to 8
8 to 16	1	CY25811	1x	8 to 16
16 to 32	M	CY25811	1x	16 to 32
4 to 8	0	CY25812	2x	8 to 16
8 to 16	1	CY25812	2x	16 to 32
16 to 32	M	CY25812	2x	32 to 64
4 to 8	0	CY25814	4x	16 to 32
8 to 16	1	CY25814	4x	32 to 64
16 to 32	M	CY25814	4x	64 to 128

Absolute Maximum Conditions (both Commercial and Industrial Grades)^[1,2]

Parameter	Description	Condition	Min	Max	Unit
V _{DD}	Supply Voltage		-0.5	4.6	V
V _{IN}	Input Voltage	Relative to V _{SS}	-0.5	V _{DD} + 0.5	VDC
T _S	Temperature, Storage	Non Functional	-65	150	°C
T _{A1}	Temperature, Operating Ambient	Functional, C-Grade	0	70	°C
T _{A2}	Temperature, Operating Ambient	Functional, I-Grade	-40	85	°C
T _J	Temperature, Junction	Functional	-	150	°C
ESD _{HBM}	ESD Protection (Human Body Model)	MIL-STD-883, Method 3015	2000	-	V
UL-94	Flammability Rating	@1/8 in.	V-0		
MSL	Moisture Sensitivity Level		1		

DC Electrical Specifications (Commercial Grade)

Parameter	Description	Condition	Min	Max	Unit
V _{DD}	3.3 Operating Voltage	3.3 ± 10%	3.97	3.63	V
V _{IL}	Input Low Voltage	S0, S1 and FRSEL Inputs	0	0.15V _{DD}	V
V _{IM}	Input Middle Voltage	S0, S1 and FRSEL Inputs	0.40V _{DD}	0.60V _{DD}	V
V _{IH}	Input High Voltage	S0, S1 and FRSEL Inputs	0.85V _{DD}	V _{DD}	V
V _{OL1}	Output Low Voltage	I _{OL} = 4 ma, SSCLK Output	-	0.4	V
V _{OL2}	Output Low Voltage	I _{OL} = 10 ma, SSCLK Output	-	1.2	V
V _{OH1}	Output High Voltage	I _{OH} = 4 ma, SSCLK Output	2.4	-	V
V _{OH2}	Output High Voltage	I _{OH} = 6 ma, SSCLK Output	2.0	-	V
C _{IN1}	Input Pin Capacitance	XIN (Pin 1) and XOUT (Pin 8)	3.5	9.0	pF
C _{IN2}	Input Pin Capacitance	All Digital Inputs	2.8	6.0	pF
C _L	Output Load Capacitor	SSCLK Output	-	15	pF
I _{DD1}	Dynamic Supply Current	Fin = 12 MHz, no load	-	28	mA
I _{DD2}	Dynamic Supply Current	Fin = 24 MHz, no load	-	33	mA
I _{DD3}	Dynamic Supply Current	Fin = 32 MHz, no load	-	40	mA

Notes

1. Operation at any Absolute Maximum Rating is not implied.
2. Single Power Supply: The voltage on any input or I/O pin cannot exceed the power pin during power up.

AC Electrical Specifications (Commercial Grade)

Parameter	Description	Condition	Min	Max	Unit
F _{IN}	Input Frequency Range	Clock, Crystal, or Ceramic Resonator Input	4	32	MHz
T _{R1}	Clock Rise Time	SSCLK, CY25811 and CY25812	2.0	5.0	ns
T _{F1}	Clock Fall Time	SSCLK, CY25811 and CY25812	1.6	4.4	ns
T _{R2}	Clock Rise Time	SSCLK, only CY25814 when FRSEL = M	1.0	2.2	ns
T _{F2}	Clock Fall Time	SSCLK, only CY25814 when FRSEL = M	0.8	2.2	ns
T _{DCIN}	Input Clock Duty Cycle	XIN	40	60	%
T _{DCCOUT}	Output Clock Duty Cycle	SSCLK	40	60	%
T _{CCJ1}	Cycle to Cycle Jitter, Spread on	Fin = 4 MHz, Fout = 4 MHz, CY25811	–	800	ps
T _{CCJ2}	Cycle to Cycle Jitter, Spread on	Fin = 8 MHz, Fout = 8 MHz, CY25811	–	480	ps
T _{CCJ3}	Cycle to Cycle Jitter, Spread on	Fin = 8 MHz, Fout = 16 MHz, CY25812	–	400	ps
T _{CCJ4}	Cycle to Cycle Jitter, Spread on	Fin = 16 MHz, Fout = 32 MHz, CY25812	–	450	ps
T _{CCJ5}	Cycle to Cycle Jitter, Spread on	Fin = 16 MHz, Fout = 64 MHz, CY25814	–	550	ps
T _{CCJ6}	Cycle to Cycle Jitter, Spread on	Fin = 32 MHz, Fout = 128 MHz, CY25814	–	380	ps
T _{SU}	PLL Lock Time	Fom V _{DD} 3.0V to valid SSCLK	–	3	ms

DC Electrical Specifications (Industrial Grade)

Parameter	Description	Condition	Min	Max	Unit
V _{DD}	3.3 Operating Voltage	3.3 ± 5%	3.135	3.465	V
V _{IL}	Input Low Voltage	S0, S1 and FRSEL Inputs	0	0.13V _{DD}	V
V _{IM}	Input Middle Voltage	S0, S1 and FRSEL Inputs	0.40V _{DD}	0.60V _{DD}	V
V _{IH}	Input High Voltage	S0, S1 and FRSEL Inputs	0.85V _{DD}	V _{DD}	V
V _{OL1}	Output Low Voltage	I _{OL} = 4 ma, SSCLK Output	–	0.4	V
V _{OL2}	Output Low Voltage	I _{OL} = 10 ma, SSCLK Output	–	1.2	V
V _{OH1}	Output High Voltage	I _{OH} = 4 ma, SSCLK Output	2.4	–	V
V _{OH2}	Output High Voltage	I _{OH} = 6 ma, SSCLK Output	2.0	–	V
C _{IN1}	Input Pin Capacitance	XIN (Pin 1) and XOUT (Pin 8)	3.5	9.0	pF
C _{IN2}	Input Pin Capacitance	All Digital Inputs	2.8	6.0	pF
C _L	Output Load Capacitor	SSCLK Output	–	15	pF
I _{DD1}	Dynamic Supply Current	Fin = 12 MHz, no load	–	28	mA
I _{DD2}	Dynamic Supply Current	Fin = 24 MHz, no load	–	33	mA
I _{DD3}	Dynamic Supply Current	Fin = 32 MHz, no load	–	41	mA

AC Electrical Specifications (Industrial Grade)

Parameter	Description	Condition	Min	Max	Unit
F _{IN}	Input Frequency Range	Clock, Crystal or Ceramic Resonator Input	4	32	MHz
T _{R1}	Clock Rise Time	SSCLK, CY25811, and CY25812	2.0	5.0	ns
T _{F1}	Clock Fall Time	SSCLK, CY25811, and CY25812	1.6	4.4	ns
T _{R2}	Clock Rise Time	SSCLK, only CY25814 when FRSEL = M	1.0	2.2	ns
T _{F2}	Clock Fall Time	SSCLK, only CY25814 when FRSEL = M	0.8	2.2	ns
T _{DCIN}	Input Clock Duty Cycle	XIN	40	60	%
T _{DCCOUT}	Output Clock Duty Cycle	SSCLK	40	60	%
T _{CCJ1}	Cycle to Cycle Jitter, Spread on	Fin = 6MHz, CY25811/12/14	–	650	ps

AC Electrical Specifications (Industrial Grade) (continued)

Parameter	Description	Condition	Min	Max	Unit
T _{CCJ2}	Cycle-to-Cycle Jitter, Spread on	Fin = 12MHz, CY25811/12/14	–	630	ps
T _{CCJ3}	Cycle-to-Cycle Jitter, Spread on	Fin = 24MHz, CY25811/12/14	–	520	ps
T _{SU}	PLL Lock Time	From V _{DD} 3.0V to valid SSCLK	–	4	ms

Characteristic Curves

The following curves demonstrate the characteristic behavior of CY25811/12/14 when tested over a number of environmental and application specific parameters. These are typical performance curves and are not meant to replace any parameter specified in DC and AC Specification tables.

Figure 3. Characteristic Curves

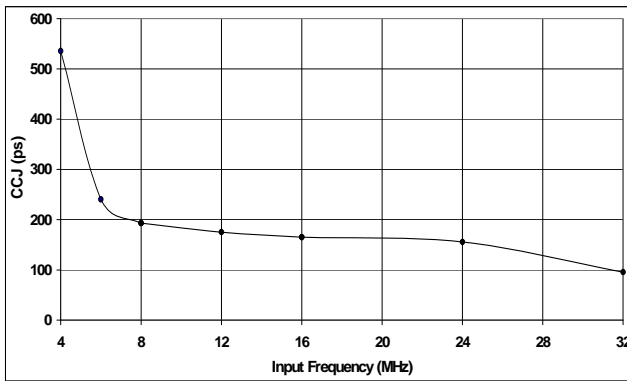

Jitter vs. Input Frequency (No Load)

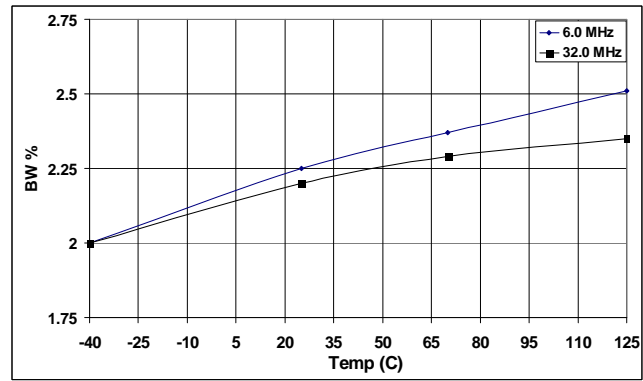

Bandwidth % vs. Temperature

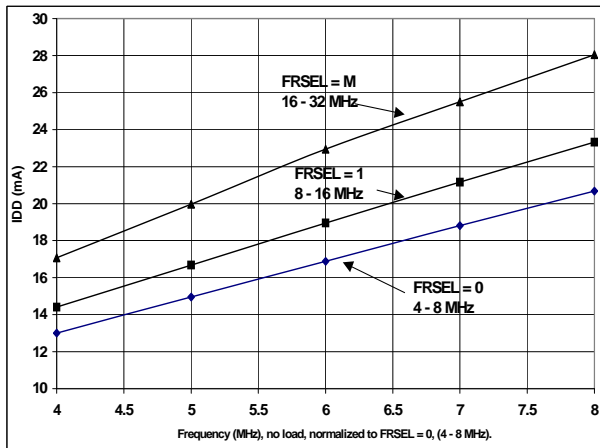

IDD vs. Frequency (FRSEL = 0, 1, M)

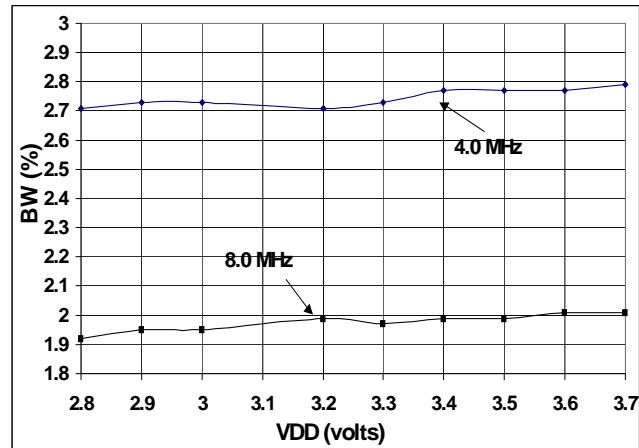

Bandwidth % vs. VDD

SSCG Profiles

CY25811/12/14 SSCG products use a non-linear “optimized” frequency profile as shown In Figure 4. The use of Cypress proprietary “optimized” frequency profile maintains flat energy distribution over the fundamental and higher order harmonics. This results in additional EMI reduction in electronic systems.

Figure 4. Spread Spectrum Profiles (Frequency versus Time)

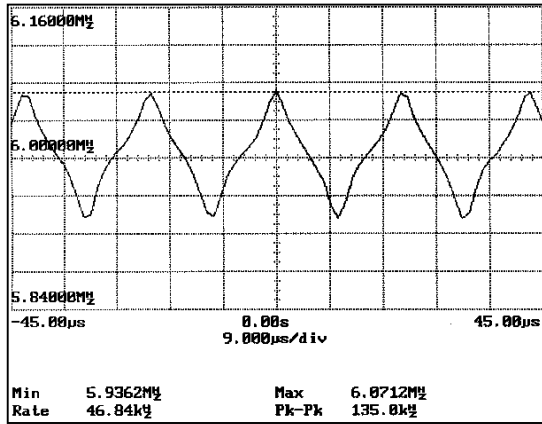

Xin = 6.0 MHz SSCLK1 = 6.0 MHz
S1, S0 = 0
FRSEL = 0 P/N = CY25811

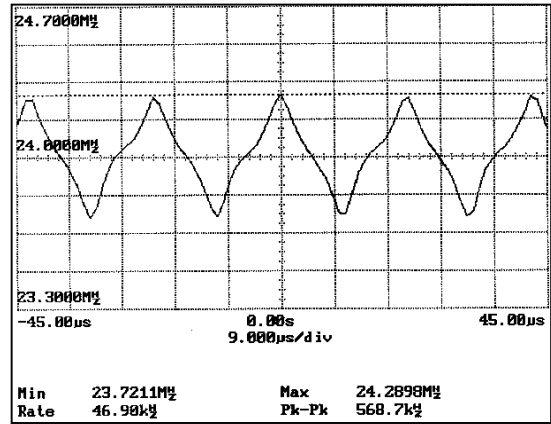

Xin = 24.0 MHz SSCLK1 = 24.0 MHz
S1, S0 = 0
FRSEL = M P/N = CY25811

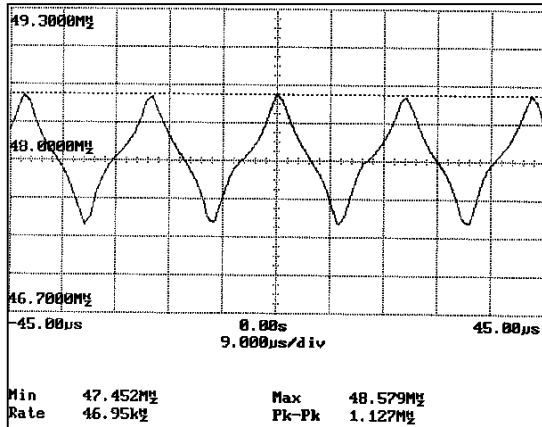

Xin = 12.0 MHz SSCLK1 = 48.0 MHz
S1, S0 = 0
FRSEL = 1 P/N = CY25814

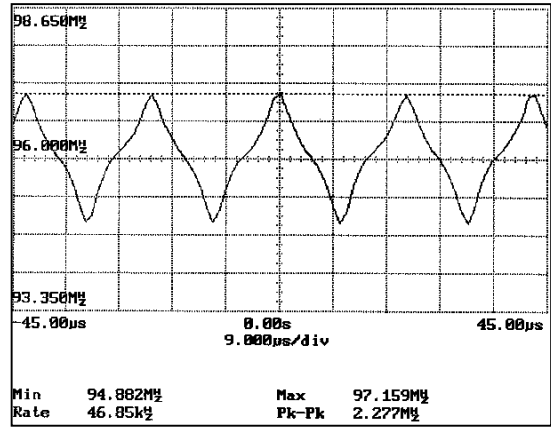

Xin = 24.0 MHz SSCLK1 = 96.0 MHz
S1, S0 = 0
FRSEL = M P/N = CY25814

Application Schematic

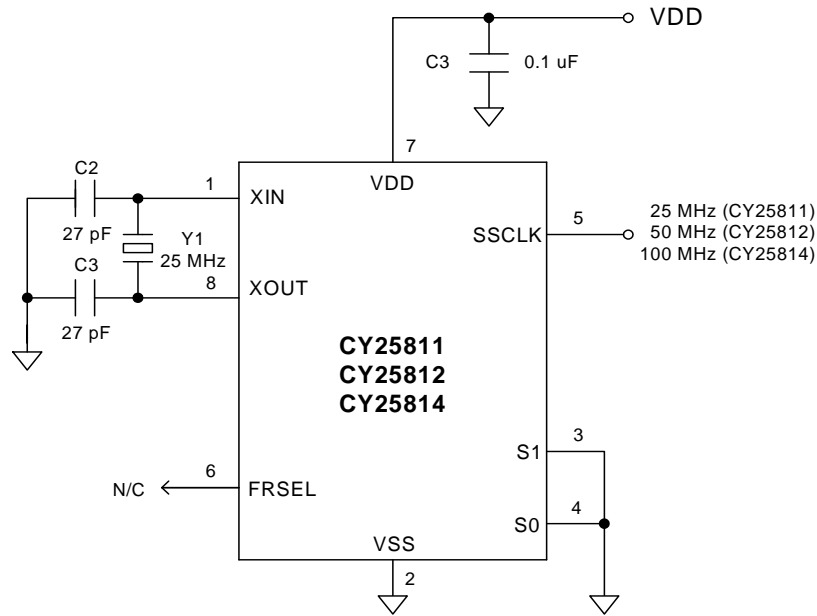

Ordering Information

Part Number	Package Type	Product Flow
Pb-Free Devices		
CY25811SXC	8-pin SOIC	Commercial, 0° to 70°C
CY25811SXCT	8-pin SOIC – Tape and Reel	Commercial, 0° to 70°C
CY25811SXI	8-pin SOIC	Industrial, -40° to 85°C
CY25811SXIT	8-pin SOIC – Tape and Reel	Industrial, -40° to 85°C
CY25811ZXC	8-pin TSSOP	Commercial, 0° to 70°C
CY25811ZXCT	8-pin TSSOP – Tape and Reel	Commercial, 0° to 70°C
CY25812SXC	8-pin SOIC	Commercial, 0° to 70°C
CY25812SXCT	8-pin SOIC – Tape and Reel	Commercial, 0° to 70°C
CY25812SXI	8-pin SOIC	Industrial, -40° to 85°C
CY25812SXIT	8-pin SOIC – Tape and Reel	Industrial, -40° to 85°C
CY25812ZXC	8-pin TSSOP	Commercial, 0° to 70°C
CY25812ZXCT	8-pin TSSOP – Tape and Reel	Commercial, 0° to 70°C
CY25814SXC	8-pin SOIC	Commercial, 0° to 70°C
CY25814SXCT	8-pin SOIC – Tape and Reel	Commercial, 0° to 70°C
CY25814SXI	8-pin SOIC	Industrial, -40° to 85°C
CY25814SXIT	8-pin SOIC – Tape and Reel	Industrial, -40° to 85°C
CY25814ZXC	8-pin TSSOP	Commercial, 0° to 70°C
CY25814ZXCT	8-pin TSSOP – Tape and Reel	Commercial, 0° to 70°C

Package Drawing and Dimensions

Figure 5. 8-Pin (150-Mil) SOIC S8 (51-85066)

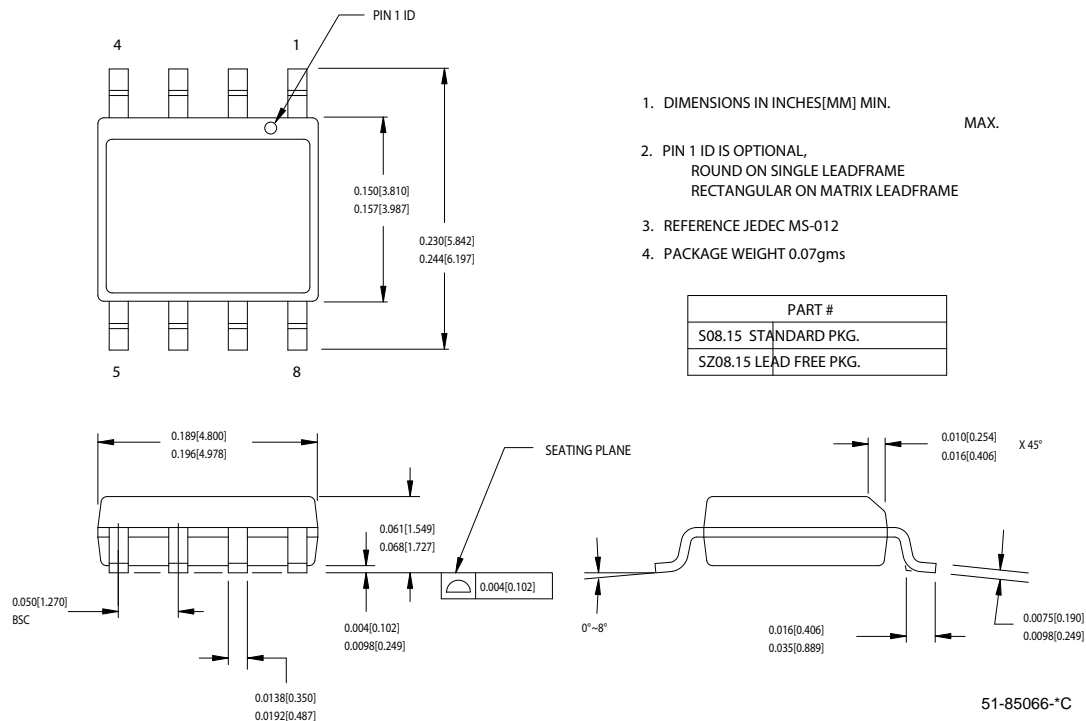
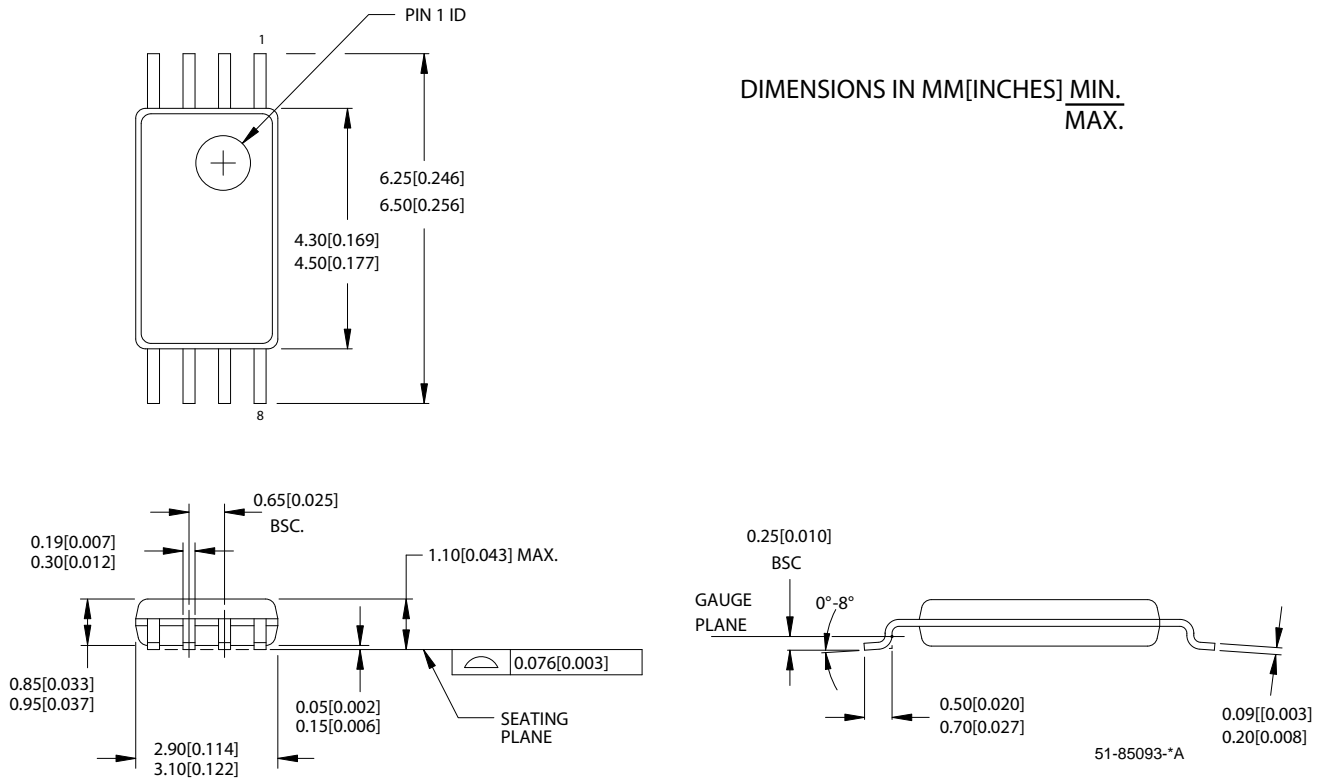

Figure 6. 8-Pin Thin Shrunk Small Outline Package (4.40 MM Body) Z8 (51-85093)



Document History Page

Document Title: CY25811/12/14 Spread Spectrum Clock Generator Document Number: 38-07112				
Rev.	ECN NO.	Submission Date	Orig. of Change	Description of Change
**	107516	06/14/02	NDP	Converted from IMI to Cypress
*A	108002	06/29/02	NDP	Deleted Junction Temp. in Absolute Maximum Ratings
*B	121578	01/29/03	RGL	Converted from Word to FrameMaker Added 8-pin TSSOP package in Commercial Temp. only Added an Industrial Temperature Range to all existing 8-pin SOIC packages
*C	125550	05/14/03	RGL	Changed IDD values from 19.6/22/27.2 to 25/30/35 in Commercial Grade DC Specs table Changed IDD values from 24/26.5/33 to 26/32/37 in Industrial grade DC Specs table Changed T _{CCJ1/2} values from 675/260 to 800/450 in Commercial grade AC Specs table Changed T _{CCJ1} value from 350 to 650 in Industrial grade AC Specs table
*D	131941	12/24/03	RGL	Removed automotive in the Applications section Changed the Output Clock Duty Cycle (T _{DCOUT}) from min. 45 and max. 55 to 40 and 60% respectively for both industrial and commercial grade Changed the min. Input Low Voltage (V _{IL}) from 0.15V _{DD} to 0.13V _{DD} Removed preliminary from the industrial AC/DC Electrical Specifications table
*E	231057	See ECN	RGL	Added Pb Free Devices
*F	1499165	See ECN	KVM	Updated Ordering Information table Corrected jitter values in features section on page 1 Changed:VDD from ±5% to ±10%, CIN1 min from 6 to 3.5 pF, CIN2 min from 3.5 to 2.8 pF, TF1 min from 2 to 1.6 ns, and TF2 min from 1.0 to 0.8 ns. Commercial grade: IDD1 max from 25 to 28 mA, IDD2 max from 30 to 33 mA, IDD3 max from 35 to 40 mA, TCCJ2 from 450 to 480 ps, TCCJ4 from 380 to 450 ps, and TCCJ5 from 380 to 550 ps Industrial grade: IDD1 max from 26 to 28 mA, IDD2 max from 32 to 33 mA, IDD3 max from 37 to 41 mA, TCCJ2 from 400 to 630 ps, and TCCJ3 from 400 to 520 ps
*G	2592288	10/23/08	CXQ/PYRS	Removed Pb package devices from Ordering Table

Sales, Solutions, and Legal Information

Worldwide Sales and Design Support

Cypress maintains a worldwide network of offices, solution centers, manufacturer's representatives, and distributors. To find the office closest to you, visit us at cypress.com/sales.

Products

PSoC	psoc.cypress.com
Clocks & Buffers	clocks.cypress.com
Wireless	wireless.cypress.com
Memories	memory.cypress.com
Image Sensors	image.cypress.com

PSoC Solutions

General	psoc.cypress.com/solutions
Low Power/Low Voltage	psoc.cypress.com/low-power
Precision Analog	psoc.cypress.com/precision-analog
LCD Drive	psoc.cypress.com/lcd-drive
CAN 2.0b	psoc.cypress.com/can
USB	psoc.cypress.com/usb

© Cypress Semiconductor Corporation, 2004-2008. The information contained herein is subject to change without notice. Cypress Semiconductor Corporation assumes no responsibility for the use of any circuitry other than circuitry embodied in a Cypress product. Nor does it convey or imply any license under patent or other rights. Cypress products are not warranted nor intended to be used for medical, life support, life saving, critical control or safety applications, unless pursuant to an express written agreement with Cypress. Furthermore, Cypress does not authorize its products for use as critical components in life-support systems where a malfunction or failure may reasonably be expected to result in significant injury to the user. The inclusion of Cypress products in life-support systems application implies that the manufacturer assumes all risk of such use and in doing so indemnifies Cypress against all charges.

Any Source Code (software and/or firmware) is owned by Cypress Semiconductor Corporation (Cypress) and is protected by and subject to worldwide patent protection (United States and foreign), United States copyright laws and international treaty provisions. Cypress hereby grants to licensee a personal, non-exclusive, non-transferable license to copy, use, modify, create derivative works of, and compile the Cypress Source Code and derivative works for the sole purpose of creating custom software and or firmware in support of licensee product to be used only in conjunction with a Cypress integrated circuit as specified in the applicable agreement. Any reproduction, modification, translation, compilation, or representation of this Source Code except as specified above is prohibited without the express written permission of Cypress.

Disclaimer: CYPRESS MAKES NO WARRANTY OF ANY KIND, EXPRESS OR IMPLIED, WITH REGARD TO THIS MATERIAL, INCLUDING, BUT NOT LIMITED TO, THE IMPLIED WARRANTIES OF MERCHANTABILITY AND FITNESS FOR A PARTICULAR PURPOSE. Cypress reserves the right to make changes without further notice to the materials described herein. Cypress does not assume any liability arising out of the application or use of any product or circuit described herein. Cypress does not authorize its products for use as critical components in life-support systems where a malfunction or failure may reasonably be expected to result in significant injury to the user. The inclusion of Cypress' product in a life-support systems application implies that the manufacturer assumes all risk of such use and in doing so indemnifies Cypress against all charges.

Use may be limited by and subject to the applicable Cypress software license agreement.