

# LT6202/LT6203/LT6204

## Single/Dual/Quad 100MHz, Rail-to-Rail Input and Output, Ultralow $1.9\text{nV}/\sqrt{\text{Hz}}$ Noise, Low Power Op Amps

### FEATURES

- **Low Noise Voltage:  $1.9\text{nV}/\sqrt{\text{Hz}}$  (100kHz)**
- **Low Supply Current: 3mA/Amp Max**
- **Gain Bandwidth Product: 100MHz**
- **Dual LT6203 in Tiny DFN Package**
- Low Distortion:  $-80\text{dB}$  at 1MHz
- Low Offset Voltage: 500 $\mu\text{V}$  Max
- Wide Supply Range: 2.5V to 12.6V
- Input Common Mode Range Includes Both Rails
- Output Swings Rail-to-Rail
- Common Mode Rejection Ratio 90dB Typ
- Unity Gain Stable
- Low Noise Current: 1.1pA/ $\sqrt{\text{Hz}}$
- Output Current: 30mA Min
- Operating Temperature Range  $-40^{\circ}\text{C}$  to  $85^{\circ}\text{C}$

### APPLICATIONS

- Low Noise, Low Power Signal Processing
- Active Filters
- Rail-to-Rail Buffer Amplifiers
- Driving A/D Converters
- DSL Receivers
- Battery Powered/Battery Backed Equipment

### DESCRIPTION

The LT<sup>®</sup>6202/LT6203/LT6204 are single/dual/quad low noise, rail-to-rail input and output unity gain stable op amps that feature  $1.9\text{nV}/\sqrt{\text{Hz}}$  noise voltage and draw only 2.5mA of supply current per amplifier. These amplifiers combine very low noise and supply current with a 100MHz gain bandwidth product, a 25V/ $\mu\text{s}$  slew rate, and are optimized for low supply signal conditioning systems.

These amplifiers maintain their performance for supplies from 2.5V to 12.6V and are specified at 3V, 5V and  $\pm 5\text{V}$  supplies. Harmonic distortion is less than  $-80\text{dBc}$  at 1MHz making these amplifiers suitable in low power data acquisition systems.

The LT6202 is available in the 5-pin SOT-23 and the 8-pin SO, while the LT6203 comes in 8-pin SO and MSOP packages with standard op amp pinouts. For compact layouts the LT6203 is also available in a tiny fine line leadless package (DFN), while the quad LT6204 is available in the 16-pin SSOP and 14-pin SO packages. These devices can be used as plug-in replacements for many op amps to improve input/output range and noise performance.

LTC and LT are registered trademarks of Linear Technology Corporation.

### TYPICAL APPLICATION

#### Low Noise 4- to 2-Wire Local Echo Cancellation Differential Receiver

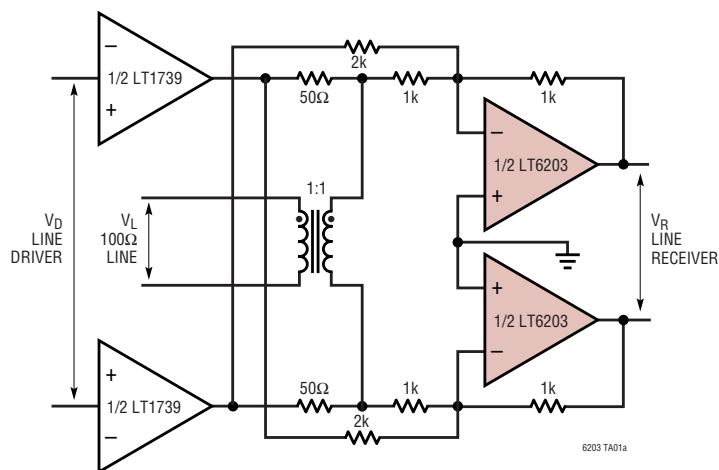

Line Receiver Integrated Noise 25kHz to 150kHz

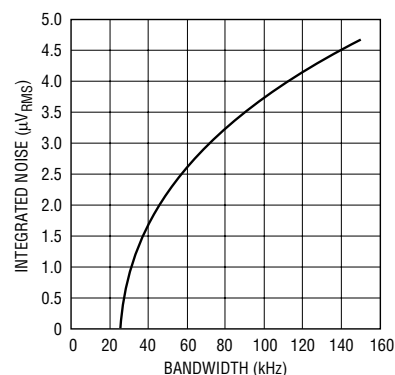

620234fa

# LT6202/LT6203/LT6204

## ABSOLUTE MAXIMUM RATINGS (Note 1)

|   |                   |   |                |
|---|-------------------|---|----------------|
| Total Supply Voltage ( $V^+$ to $V^-$ ) ..... | 12.6V             | Junction Temperature (DD Package) .....         | 125°C          |
| Input Current (Note 2) .....                  | $\pm 40\text{mA}$ | Storage Temperature Range .....                 | -65°C to 150°C |
| Output Short-Circuit Duration (Note 3) .....  | Indefinite        | Storage Temperature Range<br>(DD Package) ..... | -65°C to 125°C |
| Operating Temperature Range (Note 4) ...      | -40°C to 85°C     | Lead Temperature (Soldering, 10 sec) .....      | 300°C          |
| Specified Temperature Range (Note 5) ....     | -40°C to 85°C     |   |                |
| Junction Temperature .....                    | 150°C             |   |                |

## PACKAGE/ORDER INFORMATION

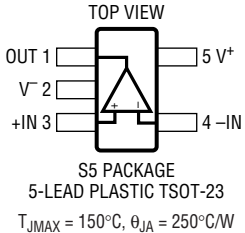
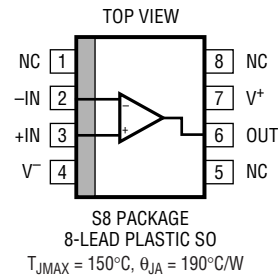
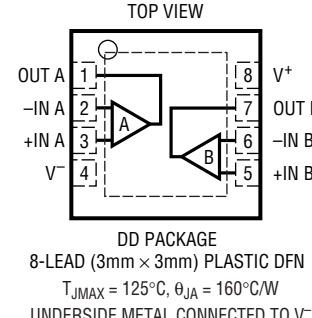
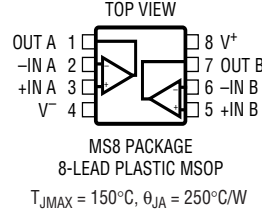
|  |                  |  |                  |                        |                 |
|--|------------------|--|------------------|------------------------|-----------------|
|  <p>S5 PACKAGE<br/>5-LEAD PLASTIC TSOT-23<br/><math>T_{JMAX} = 150^\circ\text{C}</math>, <math>\theta_{JA} = 250^\circ\text{C/W}</math></p>   |                  |  <p>S8 PACKAGE<br/>8-LEAD PLASTIC SO<br/><math>T_{JMAX} = 150^\circ\text{C}</math>, <math>\theta_{JA} = 190^\circ\text{C/W}</math></p>    |                  |                        |                 |
| ORDER PART NUMBER  | S5 PART MARKING* | ORDER PART NUMBER  | S8 PART MARKING  |                        |                 |
| LT6202CS5<br>LT6202IS5   | LTG6             | LT6202CS8<br>LT6202IS8   | 6202<br>6202I    |                        |                 |
|  <p>DD PACKAGE<br/>8-LEAD (3mm <math>\times</math> 3mm) PLASTIC DFN<br/><math>T_{JMAX} = 125^\circ\text{C}</math>, <math>\theta_{JA} = 160^\circ\text{C/W}</math><br/>UNDERSIDE METAL CONNECTED TO <math>V^-</math></p> |                  |  <p>MS8 PACKAGE<br/>8-LEAD PLASTIC MSOP<br/><math>T_{JMAX} = 150^\circ\text{C}</math>, <math>\theta_{JA} = 250^\circ\text{C/W}</math></p> |                  |                        |                 |
| ORDER PART NUMBER  | DD PART MARKING* | ORDER PART NUMBER  | MS8 PART MARKING | ORDER PART NUMBER      | S8 PART MARKING |
| LT6203CDD<br>LT6203IDD   | LAAP             | LT6203CMS8<br>LT6203IMS8   | LTB2<br>LTB3     | LT6203CS8<br>LT6203IS8 | 6203<br>6203I   |

\*The temperature grades are identified by a label on the shipping container.

**PACKAGE/ORDER INFORMATION**

|  |                        |  |                      |
|--|------------------------|--|----------------------|
| <p>GN PACKAGE<br/>16-LEAD NARROW PLASTIC SSOP<br/><math>T_{JMAX} = 150^{\circ}C, \theta_{JA} = 135^{\circ}C/W</math></p> | ORDER PART NUMBER      | <p>S PACKAGE<br/>14-LEAD PLASTIC SO<br/><math>T_{JMAX} = 150^{\circ}C, \theta_{JA} = 150^{\circ}C/W</math></p> | ORDER PART NUMBER    |
|  | LT6204CGN<br>LT6204IGN |  | LT6204CS<br>LT6204IS |
|  | GN PART MARKING        |  |                      |
|  | 6204<br>6204I          |  |                      |

Consult LTC Marketing for parts specified with wider operating temperature ranges.

**ELECTRICAL CHARACTERISTICS**  $T_A = 25^{\circ}C, V_S = 5V, 0V; V_S = 3V, 0V; V_{CM} = V_{OUT} = \text{half supply, unless otherwise noted.}$

| SYMBOL       | PARAMETER  | CONDITIONS  | MIN  | TYP  | MAX  | UNITS             |
|--------------|--|---|------|------|------|-------------------|
| $V_{OS}$     | Input Offset Voltage   | $V_S = 5V, 0V, V_{CM} = \text{Half Supply}$<br>LT6203, LT6204, LT6202S8<br>LT6202 SOT-23  |      | 0.1  | 0.5  | mV                |
|              |  |   |      | 0.1  | 0.7  | mV                |
|              |  | $V_S = 3V, 0V, V_{CM} = \text{Half Supply}$<br>LT6203, LT6204, LT6202S8<br>LT6202 SOT-23  |      | 0.6  | 1.5  | mV                |
|              |  |   |      | 0.6  | 1.7  | mV                |
|              | Input Offset Voltage Match<br>(Channel-to-Channel) (Note 6)                      | $V_S = 5V, 0V, V_{CM} = V^+ \text{ to } V^-$<br>LT6203, LT6204, LT6202S8<br>LT6202 SOT-23 |      | 0.25 | 2.0  | mV                |
|              |  |   |      | 0.25 | 2.2  | mV                |
|              |  | $V_S = 3V, 0V, V_{CM} = V^+ \text{ to } V^-$<br>LT6203, LT6204, LT6202S8<br>LT6202 SOT-23 |      | 1.0  | 3.5  | mV                |
|              |  |   |      | 1.0  | 3.7  | mV                |
| $I_B$        | Input Bias Current   | $V_{CM} = \text{Half Supply}$   | -7.0 | -1.3 |      | $\mu A$           |
|              |  | $V_{CM} = V^+$  |      | 1.3  | 2.5  | $\mu A$           |
|              |  | $V_{CM} = V^-$  | -8.8 | -3.3 |      | $\mu A$           |
| $\Delta I_B$ | $I_B$ Shift  | $V_{CM} = V^- \text{ to } V^+$  |      | 4.7  | 11.3 | $\mu A$           |
|              | $I_B$ Match (Channel-to-Channel) (Note 6)  |   |      | 0.1  | 0.6  | $\mu A$           |
| $I_{OS}$     | Input Offset Current   | $V_{CM} = \text{Half Supply}$   |      | 0.12 | 1    | $\mu A$           |
|              |  | $V_{CM} = V^+$  |      | 0.07 | 1    | $\mu A$           |
|              |  | $V_{CM} = V^-$  |      | 0.12 | 1.1  | $\mu A$           |
|              | Input Noise Voltage  | 0.1Hz to 10Hz   |      | 800  |      | nV <sub>p-p</sub> |
| $e_n$        | Input Noise Voltage Density  | $f = 100kHz, V_S = 5V$  |      | 2    |      | nV/ $\sqrt{Hz}$   |
|              |  | $f = 10kHz, V_S = 5V$   |      | 2.9  | 4.5  | nV/ $\sqrt{Hz}$   |
| $i_n$        | Input Noise Current Density, Balanced<br>Input Noise Current Density, Unbalanced | $f = 10kHz, V_S = 5V$   |      | 0.75 |      | pA/ $\sqrt{Hz}$   |
|              |  |   |      | 1.1  |      | pA/ $\sqrt{Hz}$   |
|              | Input Resistance   | Common Mode   |      | 4    |      | M $\Omega$        |
|              |  | Differential Mode   |      | 12   |      | k $\Omega$        |

620234fa

# LT6202/LT6203/LT6204

## ELECTRICAL CHARACTERISTICS

$T_A = 25^\circ\text{C}$ ,  $V_S = 5\text{V}, 0\text{V}$ ;  $V_S = 3\text{V}, 0\text{V}$ ;  $V_{CM} = V_{OUT} = \text{half supply}$ , unless otherwise noted.

| SYMBOL    | PARAMETER                                     | CONDITIONS  | MIN      | TYP      | MAX  | UNITS            |
|-----------|---|---|----------|----------|------|------------------|
| $C_{IN}$  | Input Capacitance                             | Common Mode   |          | 1.8      |      | pF               |
|           |   | Differential Mode   |          | 1.5      |      | pF               |
| $A_{VOL}$ | Large Signal Gain                             | $V_S = 5\text{V}, V_O = 0.5\text{V to } 4.5\text{V}, R_L = 1\text{k to } V_S/2$ | 40       | 70       |      | V/mV             |
|           |   | $V_S = 5\text{V}, V_O = 1\text{V to } 4\text{V}, R_L = 100\text{ to } V_S/2$    | 8.0      | 14       |      | V/mV             |
|           |   | $V_S = 3\text{V}, V_O = 0.5\text{V to } 2.5\text{V}, R_L = 1\text{k to } V_S/2$ | 17       | 40       |      | V/mV             |
| CMRR      | Common Mode Rejection Ratio                   | $V_S = 5\text{V}, V_{CM} = V^- \text{ to } V^+$                                 | 60       | 83       |      | dB               |
|           |   | $V_S = 5\text{V}, V_{CM} = 1.5\text{V to } 3.5\text{V}$                         | 80       | 100      |      | dB               |
|           |   | $V_S = 3\text{V}, V_{CM} = V^- \text{ to } V^+$                                 | 56       | 80       |      | dB               |
|           | CMRR Match (Channel-to-Channel) (Note 6)      | $V_S = 5\text{V}, V_{CM} = 1.5\text{V to } 3.5\text{V}$                         | 85       | 120      |      | dB               |
| PSRR      | Power Supply Rejection Ratio                  | $V_S = 2.5\text{V to } 10\text{V}, V_{CM} = 0\text{V}$                          | 60       | 74       |      | dB               |
|           | PSRR Match (Channel-to-Channel) (Note 6)      | $V_S = 2.5\text{V to } 10\text{V}, V_{CM} = 0\text{V}$                          | 70       | 100      |      | dB               |
|           | Minimum Supply Voltage (Note 7)               |   | 2.5      |          |      | V                |
| $V_{OL}$  | Output Voltage Swing LOW Saturation (Note 8)  | No Load   |          | 5        | 50   | mV               |
|           |   | $I_{SINK} = 5\text{mA}$   |          | 85       | 190  | mV               |
|           |   | $V_S = 5\text{V}, I_{SINK} = 20\text{mA}$                                       |          | 240      | 460  | mV               |
|           |   | $V_S = 3\text{V}, I_{SINK} = 15\text{mA}$                                       |          | 185      | 350  | mV               |
| $V_{OH}$  | Output Voltage Swing HIGH Saturation (Note 8) | No Load   |          | 25       | 75   | mV               |
|           |   | $I_{SOURCE} = 5\text{mA}$   |          | 90       | 210  | mV               |
|           |   | $V_S = 5\text{V}, I_{SOURCE} = 20\text{mA}$                                     |          | 325      | 600  | mV               |
|           |   | $V_S = 3\text{V}, I_{SOURCE} = 15\text{mA}$                                     |          | 225      | 410  | mV               |
| $I_{SC}$  | Short-Circuit Current                         | $V_S = 5\text{V}$   | $\pm 30$ | $\pm 45$ |      | mA               |
|           |   | $V_S = 3\text{V}$   | $\pm 25$ | $\pm 40$ |      | mA               |
| $I_S$     | Supply Current per Amp                        | $V_S = 5\text{V}$   |          | 2.5      | 3.0  | mA               |
|           |   | $V_S = 3\text{V}$   |          | 2.3      | 2.85 | mA               |
| GBW       | Gain Bandwidth Product                        | Frequency = 1MHz, $V_S = 5\text{V}$   |          | 90       |      | MHz              |
| SR        | Slew Rate                                     | $V_S = 5\text{V}, A_V = -1, R_L = 1\text{k}, V_O = 4\text{V}$                   | 17       | 24       |      | V/ $\mu\text{s}$ |
| FPBW      | Full Power Bandwidth (Note 10)                | $V_S = 5\text{V}, V_{OUT} = 3V_{P-P}$   | 1.8      | 2.5      |      | MHz              |
| $t_S$     | Settling Time                                 | 0.1%, $V_S = 5\text{V}, V_{STEP} = 2\text{V}, A_V = -1, R_L = 1\text{k}$        |          | 85       |      | ns               |

The ● denotes the specifications which apply over  $0^\circ\text{C} < T_A < 70^\circ\text{C}$  temperature range.  $V_S = 5\text{V}, 0\text{V}$ ;  $V_S = 3\text{V}, 0\text{V}$ ;  $V_{CM} = V_{OUT} = \text{half supply}$ , unless otherwise noted.

| SYMBOL      | PARAMETER  | CONDITIONS   | MIN | TYP  | MAX | UNITS                        |
|-------------|--|--|-----|------|-----|------------------------------|
| $V_{OS}$    | Input Offset Voltage                                     | $V_S = 5\text{V}, 0\text{V}, V_{CM} = \text{Half Supply}$<br>LT6203, LT6204, LT6202S8  | ●   | 0.2  | 0.7 | mV                           |
|             |  | LT6202 SOT-23  | ●   | 0.2  | 0.9 | mV                           |
|             |  | $V_S = 3\text{V}, 0\text{V}, V_{CM} = \text{Half Supply}$<br>LT6203, LT6204, LT6202S8  | ●   | 0.6  | 1.7 | mV                           |
|             |  | LT6202 SOT-23  | ●   | 0.6  | 1.9 | mV                           |
| $V_{OS}$    | Input Offset Voltage                                     | $V_S = 5\text{V}, 0\text{V}, V_{CM} = V^+ \text{ to } V^-$<br>LT6203, LT6204, LT6202S8 | ●   | 0.7  | 2.5 | mV                           |
|             |  | LT6202 SOT-23  | ●   | 0.7  | 2.7 | mV                           |
|             |  | $V_S = 3\text{V}, 0\text{V}, V_{CM} = V^+ \text{ to } V^-$<br>LT6203, LT6204, LT6202S8 | ●   | 1.2  | 4.0 | mV                           |
|             |  | LT6202 SOT-23  | ●   | 1.2  | 4.2 | mV                           |
| $V_{OS TC}$ | Input Offset Voltage Drift (Note 9)                      | $V_{CM} = \text{Half Supply}$  | ●   | 3.0  | 9.0 | $\mu\text{V}/^\circ\text{C}$ |
| $V_{OS}$    | Input Offset Voltage Match (Channel-to-Channel) (Note 6) | $V_{CM} = \text{Half Supply}$  | ●   | 0.15 | 0.9 | mV                           |
|             |  | $V_{CM} = V^- \text{ to } V^+$   | ●   | 0.5  | 2.3 | mV                           |

620234fa

**ELECTRICAL CHARACTERISTICS** The ● denotes the specifications which apply over 0°C < T<sub>A</sub> < 70°C temperature range. V<sub>S</sub> = 5V, 0V; V<sub>S</sub> = 3V, 0V; V<sub>CM</sub> = V<sub>OUT</sub> = half supply, unless otherwise noted.

| SYMBOL           | PARAMETER  | CONDITIONS  | MIN | TYP  | MAX  | UNITS |     |
|------------------|--|---|-----|------|------|-------|-----|
| I <sub>B</sub>   | Input Bias Current                                 | V <sub>CM</sub> = Half Supply   | ●   | -7.0 | -1.3 | μA    |     |
|                  |  | V <sub>CM</sub> = V <sup>+</sup>  | ●   |      | 1.3  |       | 2.5 |
|                  |  | V <sub>CM</sub> = V <sup>-</sup>  | ●   | -8.8 | -3.3 |       |     |
| ΔI <sub>B</sub>  | I <sub>B</sub> Shift                               | V <sub>CM</sub> = V <sup>-</sup> to V <sup>+</sup>  | ●   | 4.7  | 11.3 | μA    |     |
|                  | I <sub>B</sub> Match (Channel-to-Channel) (Note 6) |   | ●   | 0.1  | 0.6  | μA    |     |
| I <sub>OS</sub>  | Input Offset Current                               | V <sub>CM</sub> = Half Supply   | ●   | 0.15 | 1    | μA    |     |
|                  |  | V <sub>CM</sub> = V <sup>+</sup>  | ●   | 0.10 | 1    | μA    |     |
|                  |  | V <sub>CM</sub> = V <sup>-</sup>  | ●   | 0.15 | 1.1  | μA    |     |
| A <sub>VOL</sub> | Large Signal Gain                                  | V <sub>S</sub> = 5V, V <sub>O</sub> = 0.5V to 4.5V, R <sub>L</sub> = 1k to V <sub>S</sub> /2  | ●   | 35   | 60   | V/mV  |     |
|                  |  | V <sub>S</sub> = 5V, V <sub>O</sub> = 1.5V to 3.5V, R <sub>L</sub> = 100 to V <sub>S</sub> /2 | ●   | 6.0  | 12   | V/mV  |     |
|                  |  | V <sub>S</sub> = 3V, V <sub>O</sub> = 0.5V to 2.5V, R <sub>L</sub> = 1k to V <sub>S</sub> /2  | ●   | 15   | 36   | V/mV  |     |
| CMRR             | Common Mode Rejection Ratio                        | V <sub>S</sub> = 5V, V <sub>CM</sub> = V <sup>-</sup> to V <sup>+</sup>                       | ●   | 60   | 83   | dB    |     |
|                  |  | V <sub>S</sub> = 5V, V <sub>CM</sub> = 1.5V to 3.5V   | ●   | 78   | 97   | dB    |     |
|                  |  | V <sub>S</sub> = 3V, V <sub>CM</sub> = V <sup>-</sup> to V <sup>+</sup>                       | ●   | 56   | 75   | dB    |     |
|                  | CMRR Match (Channel-to-Channel) (Note 6)           | V <sub>S</sub> = 5V, V <sub>CM</sub> = 1.5V to 3.5V   | ●   | 83   | 100  | dB    |     |
| PSRR             | Power Supply Rejection Ratio                       | V <sub>S</sub> = 3V to 10V, V <sub>CM</sub> = 0V  | ●   | 60   | 70   | dB    |     |
|                  |  | PSRR Match (Channel-to-Channel) (Note 6)  | ●   | 70   | 100  | dB    |     |
|                  | Minimum Supply Voltage (Note 7)                    |   | ●   | 3.0  |      | V     |     |
| V <sub>OL</sub>  | Output Voltage Swing LOW Saturation (Note 8)       | No Load   | ●   | 5.0  | 60   | mV    |     |
|                  |  | I <sub>SINK</sub> = 5mA   | ●   | 95   | 200  | mV    |     |
|                  |  | I <sub>SINK</sub> = 15mA  | ●   | 260  | 365  | mV    |     |
| V <sub>OH</sub>  | Output Voltage Swing HIGH Saturation (Note 8)      | No Load   | ●   | 50   | 100  | mV    |     |
|                  |  | I <sub>SOURCE</sub> = 5mA   | ●   | 115  | 230  | mV    |     |
|                  |  | V <sub>S</sub> = 5V, I <sub>SOURCE</sub> = 20mA   | ●   | 360  | 635  | mV    |     |
|                  |  | V <sub>S</sub> = 3V, I <sub>SOURCE</sub> = 15mA   | ●   | 260  | 430  | mV    |     |
| I <sub>SC</sub>  | Short-Circuit Current                              | V <sub>S</sub> = 5V   | ●   | ±20  | ±33  | mA    |     |
|                  |  | V <sub>S</sub> = 3V   | ●   | ±20  | ±30  | mA    |     |
| I <sub>S</sub>   | Supply Current per Amp                             | V <sub>S</sub> = 5V   | ●   | 3.1  | 3.85 | mA    |     |
|                  |  | V <sub>S</sub> = 3V   | ●   | 2.75 | 3.50 | mA    |     |
| GBW              | Gain Bandwidth Product                             | Frequency = 1MHz  | ●   | 87   |      | MHz   |     |
| SR               | Slew Rate  | V <sub>S</sub> = 5V, A <sub>V</sub> = -1, R <sub>L</sub> = 1k, V <sub>O</sub> = 4V            | ●   | 15   | 21   | V/μs  |     |
| FPBW             | Full Power Bandwidth (Note 10)                     | V <sub>S</sub> = 5V, V <sub>OUT</sub> = 3V <sub>P-P</sub>                                     | ●   | 1.6  | 2.2  | MHz   |     |

The ● denotes the specifications which apply over -40°C < T<sub>A</sub> < 85°C temperature range. V<sub>S</sub> = 5V, 0V; V<sub>S</sub> = 3V, 0V; V<sub>CM</sub> = V<sub>OUT</sub> = half supply, unless otherwise noted. (Note 5)

| SYMBOL          | PARAMETER            | CONDITIONS   | MIN | TYP | MAX | UNITS |
|-----------------|----------------------|--|-----|-----|-----|-------|
| V <sub>OS</sub> | Input Offset Voltage | V <sub>S</sub> = 5V, 0V, V <sub>CM</sub> = Half Supply<br>LT6203, LT6204, LT6202S8<br>LT6202 SOT-23                      | ●   | 0.2 | 0.8 | mV    |
|                 |                      |  | ●   | 0.2 | 1.0 | mV    |
|                 |                      | V <sub>S</sub> = 3V, 0V, V <sub>CM</sub> = Half Supply<br>LT6203, LT6204, LT6202S8<br>LT6202 SOT-23                      | ●   | 0.6 | 2.0 | mV    |
|                 |                      |  | ●   | 0.6 | 2.2 | mV    |
|                 |                      | V <sub>S</sub> = 5V, 0V, V <sub>CM</sub> = V <sup>+</sup> to V <sup>-</sup><br>LT6203, LT6204, LT6202S8<br>LT6202 SOT-23 | ●   | 1.0 | 3.0 | mV    |
|                 |                      |  | ●   | 1.0 | 3.5 | mV    |
|                 |                      | V <sub>S</sub> = 3V, 0V, V <sub>CM</sub> = V <sup>+</sup> to V <sup>-</sup><br>LT6203, LT6204, LT6202S8<br>LT6202 SOT-23 | ●   | 1.4 | 4.5 | mV    |
|                 |                      |  | ●   | 1.4 | 4.7 | mV    |

620234fa

# LT6202/LT6203/LT6204

## ELECTRICAL CHARACTERISTICS

The ● denotes the specifications which apply over  $-40^{\circ}\text{C} < T_A < 85^{\circ}\text{C}$  temperature range.  $V_S = 5\text{V}, 0\text{V}$ ;  $V_S = 3\text{V}, 0\text{V}$ ;  $V_{CM} = V_{OUT} = \text{half supply}$ , unless otherwise noted. (Note 5)

| SYMBOL                         | PARAMETER  | CONDITIONS  | MIN  | TYP      | MAX      | UNITS                          |    |
|--------------------------------|--|---|--|----------|----------|--------------------------------|----|
| $V_{OS\ TC}$                   | Input Offset Voltage Drift (Note 9)                      | $V_{CM} = \text{Half Supply}$   | ●  | 3.0      | 9.0      | $\mu\text{V}/^{\circ}\text{C}$ |    |
|                                | Input Offset Voltage Match (Channel-to-Channel) (Note 6) | $V_{CM} = \text{Half Supply}$   | ●  | 0.3      | 1.0      | mV                             |    |
| $V_{CM} = V^- \text{ to } V^+$ |  | ●   | 0.7  | 2.5      | mV       |                                |    |
| $I_B$                          | Input Bias Current                                       | $V_{CM} = \text{Half Supply}$   | ●  | -7.0     | -1.3     | $\mu\text{A}$                  |    |
|                                |  | $V_{CM} = V^+$  | ●  |          | 1.3      | $\mu\text{A}$                  |    |
|                                |  | $V_{CM} = V^-$  | ●  | -8.8     | -3.3     | $\mu\text{A}$                  |    |
| $\Delta I_B$                   | $I_B$ Shift  | $V_{CM} = V^- \text{ to } V^+$  | ●  | 4.7      | 11.3     | $\mu\text{A}$                  |    |
|                                | $I_B$ Match (Channel-to-Channel) (Note 6)                |   | ●  | 0.1      | 0.6      | $\mu\text{A}$                  |    |
| $I_{OS}$                       | Input Offset Current                                     | $V_{CM} = \text{Half Supply}$   | ●  | 0.2      | 1        | $\mu\text{A}$                  |    |
|                                |  | $V_{CM} = V^+$  | ●  | 0.2      | 1.1      | $\mu\text{A}$                  |    |
|                                |  | $V_{CM} = V^-$  | ●  | 0.2      | 1.2      | $\mu\text{A}$                  |    |
| $A_{VOL}$                      | Large Signal Gain  | $V_S = 5\text{V}, V_O = 0.5\text{V to } 4.5\text{V}, R_L = 1\text{k to } V_S/2$   | ●  | 32       | 60       | V/mV                           |    |
|                                |  | $V_S = 5\text{V}, V_O = 1.5\text{V to } 3.5\text{V}, R_L = 100 \text{ to } V_S/2$ | ●  | 4.0      | 10       | V/mV                           |    |
|                                |  | $V_S = 3\text{V}, V_O = 0.5\text{V to } 2.5\text{V}, R_L = 1\text{k to } V_S/2$   | ●  | 13       | 32       | V/mV                           |    |
| CMRR                           | Common Mode Rejection Ratio                              | $V_S = 5\text{V}, V_{CM} = V^- \text{ to } V^+$                                   | ●  | 60       | 80       | dB                             |    |
|                                |  | $V_S = 5\text{V}, V_{CM} = 1.5\text{V to } 3.5\text{V}$                           | ●  | 75       | 95       | dB                             |    |
|                                |  | $V_S = 3\text{V}, V_{CM} = V^- \text{ to } V^+$                                   | ●  | 56       | 75       | dB                             |    |
|                                | CMRR Match (Channel-to-Channel) (Note 6)                 | $V_S = 5\text{V}, V_{CM} = 1.5\text{V to } 3.5\text{V}$                           | ●  | 80       | 100      | dB                             |    |
| PSRR                           | Power Supply Rejection Ratio                             | $V_S = 3\text{V to } 10\text{V}, V_{CM} = 0\text{V}$                              | ●  | 60       | 70       | dB                             |    |
|                                |  | PSRR Match (Channel-to-Channel) (Note 6)  | $V_S = 3\text{V to } 10\text{V}, V_{CM} = 0\text{V}$ | ●        | 70       | 100                            | dB |
|                                |  | Minimum Supply Voltage (Note 7)   | ●  | 3.0      |          | V                              |    |
| $V_{OL}$                       | Output Voltage Swing LOW Saturation (Note 8)             | No Load   | ●  | 6        | 70       | mV                             |    |
|                                |  | $I_{SINK} = 5\text{mA}$   | ●  | 95       | 210      | mV                             |    |
|                                |  | $I_{SINK} = 15\text{mA}$  | ●  | 210      | 400      | mV                             |    |
| $V_{OH}$                       | Output Voltage Swing HIGH Saturation (Note 8)            | No Load   | ●  | 55       | 110      | mV                             |    |
|                                |  | $I_{SOURCE} = 5\text{mA}$   | ●  | 125      | 240      | mV                             |    |
|                                |  | $V_S = 5\text{V}, I_{SOURCE} = 15\text{mA}$                                       | ●  | 370      | 650      | mV                             |    |
|                                |  | $V_S = 3\text{V}, I_{SOURCE} = 15\text{mA}$                                       | ●  | 270      | 650      | mV                             |    |
| $I_{SC}$                       | Short-Circuit Current                                    | $V_S = 5\text{V}$   | ●  | $\pm 15$ | $\pm 25$ | mA                             |    |
|                                |  | $V_S = 3\text{V}$   | ●  | $\pm 15$ | $\pm 23$ | mA                             |    |
| $I_S$                          | Supply Current per Amp                                   | $V_S = 5\text{V}$   | ●  | 3.3      | 4.1      | mA                             |    |
|                                |  | $V_S = 3\text{V}$   | ●  | 3.0      | 3.65     | mA                             |    |
| GBW                            | Gain Bandwidth Product                                   | Frequency = 1MHz  | ●  | 83       |          | MHz                            |    |
| SR                             | Slew Rate  | $V_S = 5\text{V}, A_V = -1, R_L = 1\text{k}, V_O = 4\text{V}$                     | ●  | 12       | 17       | V/ $\mu\text{s}$               |    |
| FPBW                           | Full Power Bandwidth (Note 10)                           | $V_S = 5\text{V}, V_{OUT} = 3V_{P-P}$   | ●  | 1.3      | 1.8      | MHz                            |    |

**ELECTRICAL CHARACTERISTICS**  $T_A = 25^\circ\text{C}$ ,  $V_S = \pm 5\text{V}$ ;  $V_{CM} = V_{OUT} = 0\text{V}$ , unless otherwise noted.

| SYMBOL                                   | PARAMETER  | CONDITIONS   | MIN  | TYP   | MAX               | UNITS  |
|--|--|--|--|---|-------------------|--|
| $V_{OS}$                                 | Input Offset Voltage                                     | LT6203, LT6204, LT6202S8<br>$V_{CM} = 0\text{V}$<br>$V_{CM} = V^+$<br>$V_{CM} = V^-$ |  | 1.0<br>2.6<br>2.3   | 2.5<br>5.5<br>5.0 | mV<br>mV<br>mV   |
|  |  | LT6202 SOT-23<br>$V_{CM} = 0\text{V}$<br>$V_{CM} = V^+$<br>$V_{CM} = V^-$            |  | 1.0<br>2.6<br>2.3   | 2.7<br>6.0<br>5.5 | mV<br>mV<br>mV   |
|  | Input Offset Voltage Match (Channel-to-Channel) (Note 6) | $V_{CM} = 0\text{V}$<br>$V_{CM} = V^-$ to $V^+$                                      |  | 0.2<br>0.4  | 1.0<br>2.0        | mV<br>mV   |
| $I_B$                                    | Input Bias Current                                       | $V_{CM} = \text{Half Supply}$<br>$V_{CM} = V^+$<br>$V_{CM} = V^-$                    | -7.0<br>-9.5   | -1.3<br>1.3<br>-3.8   | 3.0               | $\mu\text{A}$<br>$\mu\text{A}$<br>$\mu\text{A}$              |
|  |  | $V_{CM} = V^-$ to $V^+$  |  | 5.3   | 12.5              | $\mu\text{A}$  |
|  | $I_B$ Match (Channel-to-Channel) (Note 6)                |  |  | 0.1   | 0.6               | $\mu\text{A}$  |
| $I_{OS}$                                 | Input Offset Current                                     | $V_{CM} = \text{Half Supply}$<br>$V_{CM} = V^+$<br>$V_{CM} = V^-$                    |  | 0.15<br>0.2<br>0.35   | 1<br>1.2<br>1.3   | $\mu\text{A}$<br>$\mu\text{A}$<br>$\mu\text{A}$              |
|  |  | Input Noise Voltage  | 0.1Hz to 10Hz  | 800   |                   | $\text{nV}_{\text{P-P}}$                                     |
| $e_n$                                    | Input Noise Voltage Density                              | $f = 100\text{kHz}$<br>$f = 10\text{kHz}$  |  | 1.9<br>2.8  | 4.5               | $\text{nV}/\sqrt{\text{Hz}}$<br>$\text{nV}/\sqrt{\text{Hz}}$ |
|  |  | $i_n$  | Input Noise Current Density, Balanced<br>Input Noise Current Density, Unbalanced | $f = 10\text{kHz}$  | 0.75<br>1.1       |  |
| Input Resistance                         | Common Mode  |  |  |   | 4                 |  |
|  | Differential Mode  |  | 12   |   | $\text{k}\Omega$  |  |
| $C_{IN}$                                 | Input Capacitance  | Common Mode  |  | 1.8   |                   | pF   |
|  |  | Differential Mode  |  | 1.5   |                   | pF   |
| $A_{VOL}$                                | Large Signal Gain  | $V_O = \pm 4.5\text{V}$ , $R_L = 1\text{k}$<br>$V_O = \pm 2.5\text{V}$ , $R_L = 100$ | 75<br>11   | 130<br>19   |                   | V/mV<br>V/mV   |
|  |  | CMRR   | Common Mode Rejection Ratio  | $V_{CM} = V^-$ to $V^+$<br>$V_{CM} = -2\text{V}$ to $2\text{V}$ | 65<br>85          | 85<br>98   |
| CMRR Match (Channel-to-Channel) (Note 6) | $V_{CM} = -2\text{V}$ to $2\text{V}$                     |  |  | 85  | 120               | dB   |
| PSRR                                     | Power Supply Rejection Ratio                             | $V_S = \pm 1.25\text{V}$ to $\pm 5\text{V}$  | 60   | 74  |                   | dB   |
|  |  | PSRR Match (Channel-to-Channel) (Note 6)   | $V_S = \pm 1.25\text{V}$ to $\pm 5\text{V}$                                      | 70  | 100               | dB   |
| $V_{OL}$                                 | Output Voltage Swing LOW Saturation (Note 8)             | No Load  |  | 5   | 50                | mV   |
|  |  | $I_{SINK} = 5\text{mA}$  |  | 87  | 190               | mV   |
|  |  | $I_{SINK} = 20\text{mA}$   |  | 245   | 460               | mV   |
| $V_{OH}$                                 | Output Voltage Swing HIGH Saturation (Note 8)            | No Load  |  | 40  | 95                | mV   |
|  |  | $I_{SOURCE} = 5\text{mA}$  |  | 95  | 210               | mV   |
|  |  | $I_{SOURCE} = 20\text{mA}$   |  | 320   | 600               | mV   |
| $I_{SC}$                                 | Short-Circuit Current                                    |  | $\pm 30$   | $\pm 40$  |                   | mA   |
| $I_S$                                    | Supply Current per Amp                                   |  |  | 2.8   | 3.5               | mA   |
| GBW                                      | Gain Bandwidth Product                                   | Frequency = 1MHz   | 70   | 100   |                   | MHz  |
| SR                                       | Slew Rate  | $A_V = -1$ , $R_L = 1\text{k}$ , $V_O = 4\text{V}$                                   | 18   | 25  |                   | V/ $\mu\text{s}$   |
| FPBW                                     | Full Power Bandwidth (Note 10)                           | $V_{OUT} = 3V_{\text{P-P}}$  | 1.9  | 2.6   |                   | MHz  |
| $t_S$                                    | Settling Time  | 0.1%, $V_{\text{STEP}} = 2\text{V}$ , $A_V = -1$ , $R_L = 1\text{k}$                 |  | 78  |                   | ns   |
| dG                                       | Differential Gain (Note 11)                              | $A_V = 2$ , $R_F = R_G = 499\Omega$ , $R_L = 2\text{k}$                              |  | 0.05  |                   | %  |
| dP                                       | Differential Phase (Note 11)                             | $A_V = 2$ , $R_F = R_G = 499\Omega$ , $R_L = 2\text{k}$                              |  | 0.03  |                   | DEG  |

# LT6202/LT6203/LT6204

## ELECTRICAL CHARACTERISTICS

The ● denotes the specifications which apply over 0°C < T<sub>A</sub> < 70°C temperature range. V<sub>S</sub> = ±5V; V<sub>CM</sub> = V<sub>OUT</sub> = 0V, unless otherwise noted.

| SYMBOL             | PARAMETER  | CONDITIONS   | MIN | TYP  | MAX  | UNITS |
|--------------------|--|--|-----|------|------|-------|
| V <sub>OS</sub>    | Input Offset Voltage                                     | LT6203, LT6204, LT6202S8<br>V <sub>CM</sub> = 0V<br>V <sub>CM</sub> = V <sup>+</sup><br>V <sub>CM</sub> = V <sup>-</sup> | ●   | 1.6  | 2.8  | mV    |
|                    |  | ●  | 3.2 | 6.8  | mV   |       |
|                    |  | ●  | 2.8 | 5.8  | mV   |       |
| V <sub>OS</sub> TC | Input Offset Voltage Drift (Note 9)                      | LT6202 SOT-23<br>V <sub>CM</sub> = 0V<br>V <sub>CM</sub> = V <sup>+</sup><br>V <sub>CM</sub> = V <sup>-</sup>            | ●   | 1.6  | 3.0  | mV    |
|                    |  | ●  | 3.2 | 7.3  | mV   |       |
|                    |  | ●  | 2.8 | 6.3  | mV   |       |
| V <sub>OS</sub> TC | Input Offset Voltage Match (Channel-to-Channel) (Note 6) | V <sub>CM</sub> = Half Supply<br>V <sub>CM</sub> = V <sup>-</sup> to V <sup>+</sup>                                      | ●   | 7.5  | 24   | μV/°C |
| I <sub>B</sub>     | Input Bias Current                                       | V <sub>CM</sub> = Half Supply<br>V <sub>CM</sub> = V <sup>+</sup><br>V <sub>CM</sub> = V <sup>-</sup>                    | ●   | -7.0 | -1.4 | μA    |
|                    |  | ●  |     | 1.8  | 3.6  | μA    |
|                    |  | ●  | -10 | -4.3 | μA   |       |
| ΔI <sub>B</sub>    | I <sub>B</sub> Shift                                     | V <sub>CM</sub> = V <sup>-</sup> to V <sup>+</sup>   | ●   | 5.4  | 13   | μA    |
|                    | I <sub>B</sub> Match (Channel-to-Channel) (Note 6)       |  | ●   | 0.15 | 0.7  | μA    |
| I <sub>OS</sub>    | Input Offset Current                                     | V <sub>CM</sub> = Half Supply<br>V <sub>CM</sub> = V <sup>+</sup><br>V <sub>CM</sub> = V <sup>-</sup>                    | ●   | 0.1  | 1    | μA    |
|                    |  | ●  |     | 0.2  | 1.2  | μA    |
|                    |  | ●  |     | 0.4  | 1.4  | μA    |
| A <sub>VOL</sub>   | Large Signal Gain  | V <sub>O</sub> = ±4.5V, R <sub>L</sub> = 1k<br>V <sub>O</sub> = ±2V, R <sub>L</sub> = 100                                | ●   | 70   | 120  | V/mV  |
|                    |  | ●  | 10  | 18   | V/mV |       |
| CMRR               | Common Mode Rejection Ratio                              | V <sub>CM</sub> = V <sup>-</sup> to V <sup>+</sup><br>V <sub>CM</sub> = -2V to 2V  | ●   | 65   | 84   | dB    |
|                    |  | ●  | 83  | 95   | dB   |       |
|                    | CMRR Match (Channel-to-Channel) (Note 6)                 | V <sub>CM</sub> = -2V to 2V  | ●   | 83   | 110  | dB    |
| PSRR               | Power Supply Rejection Ratio                             | V <sub>S</sub> = ±1.5V to ±5V  | ●   | 60   | 70   | dB    |
|                    |  | V <sub>S</sub> = ±1.5V to ±5V  | ●   | 70   | 100  | dB    |
| V <sub>OL</sub>    | Output Voltage Swing LOW Saturation (Note 8)             | No Load  | ●   | 6    | 70   | mV    |
|                    |  | I <sub>SINK</sub> = 5mA  | ●   | 95   | 200  | mV    |
|                    |  | I <sub>SINK</sub> = 15mA   | ●   | 210  | 400  | mV    |
| V <sub>OH</sub>    | Output Voltage Swing HIGH Saturation (Note 8)            | No Load  | ●   | 65   | 120  | mV    |
|                    |  | I <sub>SOURCE</sub> = 5mA  | ●   | 125  | 240  | mV    |
|                    |  | I <sub>SOURCE</sub> = 20mA   | ●   | 350  | 625  | mV    |
| I <sub>SC</sub>    | Short-Circuit Current                                    |  | ●   | ±25  | ±34  | mA    |
| I <sub>S</sub>     | Supply Current per Amp                                   |  | ●   | 3.5  | 4.3  | mA    |
| GBW                | Gain Bandwidth Product                                   | Frequency = 1MHz   | ●   | 95   |      | MHz   |
| SR                 | Slew Rate  | A <sub>V</sub> = -1, R <sub>L</sub> = 1k, V <sub>O</sub> = 4V  | ●   | 16   | 22   | V/μs  |
| FPBW               | Full Power Bandwidth (Note 10)                           | V <sub>OUT</sub> = 3V <sub>P-P</sub>   | ●   | 1.7  | 2.3  | MHz   |

The ● denotes the specifications which apply over -40°C < T<sub>A</sub> < 85°C temperature range. V<sub>S</sub> = ±5V; V<sub>CM</sub> = V<sub>OUT</sub> = 0V, unless otherwise noted. (Note 5)

| SYMBOL          | PARAMETER            | CONDITIONS   | MIN | TYP | MAX | UNITS |
|-----------------|----------------------|--|-----|-----|-----|-------|
| V <sub>OS</sub> | Input Offset Voltage | LT6203, LT6204, LT6202S8<br>V <sub>CM</sub> = 0V<br>V <sub>CM</sub> = V <sup>+</sup><br>V <sub>CM</sub> = V <sup>-</sup> | ●   | 1.7 | 3.0 | mV    |
|                 |                      | ●  | 3.8 | 7.5 | mV  |       |
|                 |                      | ●  | 3.5 | 6.6 | mV  |       |
|                 |                      | LT6202 SOT-23<br>V <sub>CM</sub> = 0V<br>V <sub>CM</sub> = V <sup>+</sup><br>V <sub>CM</sub> = V <sup>-</sup>            | ●   | 1.7 | 3.2 | mV    |
|                 |                      | ●  | 3.8 | 7.7 | mV  |       |
|                 |                      | ●  | 3.5 | 6.7 | mV  |       |

620234fa



**ELECTRICAL CHARACTERISTICS** The ● denotes the specifications which apply over  $-40^{\circ}\text{C} < T_A < 85^{\circ}\text{C}$  temperature range.  $V_S = \pm 5\text{V}$ ;  $V_{CM} = V_{OUT} = 0\text{V}$ , unless otherwise noted. (Note 5)

| SYMBOL       | PARAMETER  | CONDITIONS  | MIN    | TYP        | MAX        | UNITS                          |
|--------------|--|---|--------|------------|------------|--------------------------------|
| $V_{OS\ TC}$ | Input Offset Voltage Drift (Note 9)                      | $V_{CM} = \text{Half Supply}$   | ●      | 7.5        | 24         | $\mu\text{V}/^{\circ}\text{C}$ |
|              | Input Offset Voltage Match (Channel-to-Channel) (Note 6) | $V_{CM} = 0\text{V}$<br>$V_{CM} = V^- \text{ to } V^+$                | ●<br>● | 0.3<br>0.6 | 1.0<br>2.5 | mV<br>mV                       |
| $I_B$        | Input Bias Current                                       | $V_{CM} = \text{Half Supply}$   | ●      | -7.0       | -1.4       | $\mu\text{A}$                  |
|              |  | $V_{CM} = V^+$  | ●      |            | 1.8        | $\mu\text{A}$                  |
|              |  | $V_{CM} = V^-$  | ●      | -10        | -4.5       | $\mu\text{A}$                  |
| $\Delta I_B$ | $I_B$ Shift  | $V_{CM} = V^- \text{ to } V^+$  | ●      | 5.4        | 13         | $\mu\text{A}$                  |
|              | $I_B$ Match (Channel-to-Channel) (Note 6)                |   | ●      | 0.15       | 0.7        | $\mu\text{A}$                  |
| $I_{OS}$     | Input Offset Current                                     | $V_{CM} = \text{Half Supply}$   | ●      | 0.15       | 1          | $\mu\text{A}$                  |
|              |  | $V_{CM} = V^+$  | ●      | 0.3        | 1.2        | $\mu\text{A}$                  |
|              |  | $V_{CM} = V^-$  | ●      | 0.5        | 1.6        | $\mu\text{A}$                  |
| $A_{VOL}$    | Large Signal Gain  | $V_O = \pm 4.5\text{V}$ , $R_L = 1\text{k}$                           | ●      | 60         | 110        | V/mV                           |
|              |  | $V_O = \pm 1.5\text{V}$ , $R_L = 100$                                 | ●      | 6.0        | 13         | V/mV                           |
| CMRR         | Common Mode Rejection Ratio                              | $V_{CM} = V^- \text{ to } V^+$<br>$V_{CM} = -2\text{V to } 2\text{V}$ | ●<br>● | 65<br>80   | 84<br>95   | dB<br>dB                       |
|              | CMRR Match (Channel-to-Channel) (Note 6)                 | $V_{CM} = -2\text{V to } 2\text{V}$                                   | ●      | 80         | 110        | dB                             |
| PSRR         | Power Supply Rejection Ratio                             | $V_S = \pm 1.5\text{V to } \pm 5\text{V}$                             | ●      | 60         | 70         | dB                             |
|              | PSRR Match (Channel-to-Channel) (Note 6)                 | $V_S = \pm 1.5\text{V to } \pm 5\text{V}$                             | ●      | 70         | 100        | dB                             |
| $V_{OL}$     | Output Voltage Swing LOW Saturation (Note 8)             | No Load   | ●      | 7          | 75         | mV                             |
|              |  | $I_{SINK} = 5\text{mA}$   | ●      | 98         | 205        | mV                             |
|              |  | $I_{SINK} = 15\text{mA}$  | ●      | 260        | 500        | mV                             |
| $V_{OH}$     | Output Voltage Swing HIGH Saturation (Note 8)            | No Load   | ●      | 70         | 130        | mV                             |
|              |  | $I_{SOURCE} = 5\text{mA}$   | ●      | 130        | 250        | mV                             |
|              |  | $I_{SOURCE} = 15\text{mA}$  | ●      | 360        | 640        | mV                             |
| $I_{SC}$     | Short-Circuit Current                                    |   | ●      | $\pm 15$   | $\pm 25$   | mA                             |
| $I_S$        | Supply Current per Amp                                   |   | ●      | 3.8        | 4.5        | mA                             |
| GBW          | Gain Bandwidth Product                                   | Frequency = 1MHz  | ●      | 90         |            | MHz                            |
| SR           | Slew Rate  | $A_V = -1$ , $R_L = 1\text{k}$ , $V_O = 4\text{V}$                    | ●      | 13         | 18         | V/ $\mu\text{s}$               |
| FPBW         | Full Power Bandwidth (Note 10)                           | $V_{OUT} = 3V_{P-P}$  | ●      | 1.4        | 1.9        | MHz                            |

**Note 1:** Absolute maximum ratings are those values beyond which the life of the device may be impaired.

**Note 2:** Inputs are protected by back-to-back diodes and diodes to each supply. If the inputs are taken beyond the supplies or the differential input voltage exceeds 0.7V, the input current must be limited to less than 40mA.

**Note 3:** A heat sink may be required to keep the junction temperature below the absolute maximum rating when the output is shorted indefinitely.

**Note 4:** The LT6202C/LT6202I, LT6203C/LT6203I and LT6204C/LT6204I are guaranteed functional over the temperature range of  $-40^{\circ}\text{C}$  and  $85^{\circ}\text{C}$ .

**Note 5:** The LT6202C/LT6203C/LT6204C are guaranteed to meet specified performance from  $0^{\circ}\text{C}$  to  $70^{\circ}\text{C}$ . The LT6202C/LT6203C/LT6204C are designed, characterized and expected to meet specified performance from  $-40^{\circ}\text{C}$  to  $85^{\circ}\text{C}$ , but are not tested or QA sampled at these temperatures.

The LT6202I/LT6203I/LT6204I are guaranteed to meet specified performance from  $-40^{\circ}\text{C}$  to  $85^{\circ}\text{C}$ .

**Note 6:** Matching parameters are the difference between the two amplifiers A and D and between B and C of the LT6204; between the two amplifiers of the LT6203. CMRR and PSRR match are defined as follows: CMRR and PSRR are measured in  $\mu\text{V/V}$  on the identical amplifiers. The difference is calculated between the matching sides in  $\mu\text{V/V}$ . The result is converted to dB.

**Note 7:** Minimum supply voltage is guaranteed by power supply rejection ratio test.

**Note 8:** Output voltage swings are measured between the output and power supply rails.

**Note 9:** This parameter is not 100% tested.

**Note 10:** Full-power bandwidth is calculated from the slew rate:  $FPBW = SR/2\pi V_P$

**Note 11:** Differential gain and phase are measured using a Tektronix TSG120YC/NTSC signal generator and a Tektronix 1780R Video Measurement Set. The resolution of this equipment is 0.1% and  $0.1^{\circ}$ . Ten identical amplifier stages were cascaded giving an effective resolution of 0.01% and  $0.01^{\circ}$ .

TYPICAL PERFORMANCE CHARACTERISTICS

$V_{OS}$  Distribution,  $V_{CM} = V^+/2$

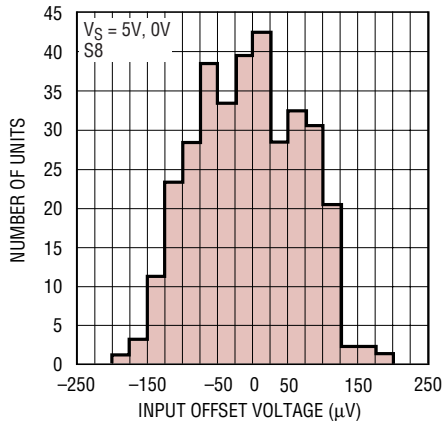

LT6202/03/04 G01

$V_{OS}$  Distribution,  $V_{CM} = V^+$

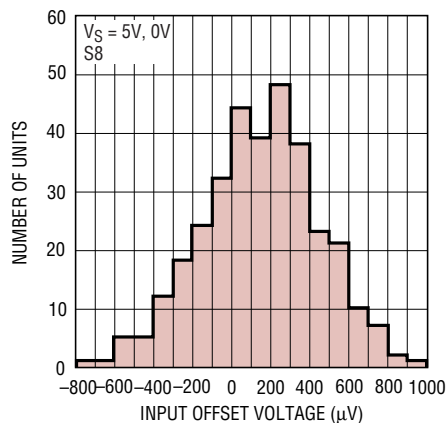

LT6202/03/04 G02

$V_{OS}$  Distribution,  $V_{CM} = V^-$

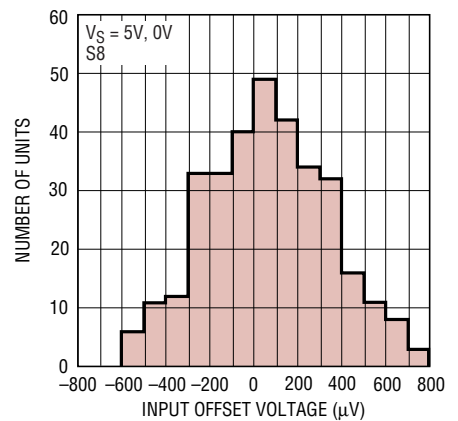

LT6202/03/04 G03

Supply Current vs Supply Voltage (Both Amplifiers)

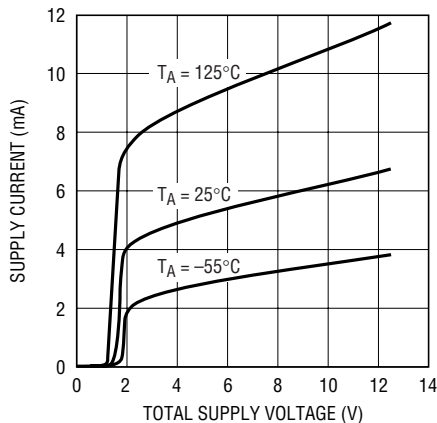

LT6202/03/04 G04

Offset Voltage vs Input Common Mode Voltage

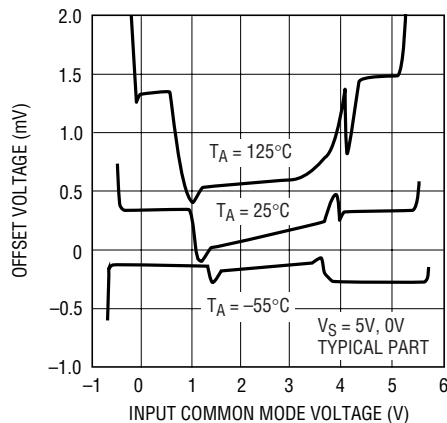

LT6202/03/04 G05

Input Bias Current vs Common Mode Voltage

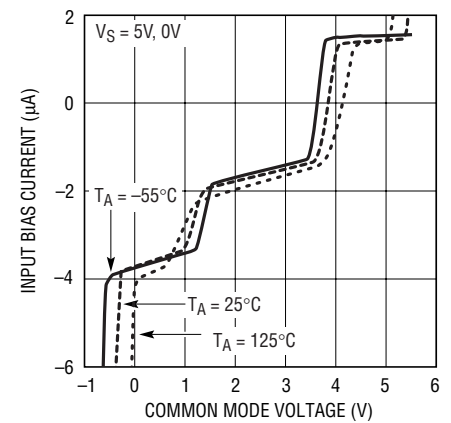

LT6202/03/04 G06

Input Bias Current vs Temperature

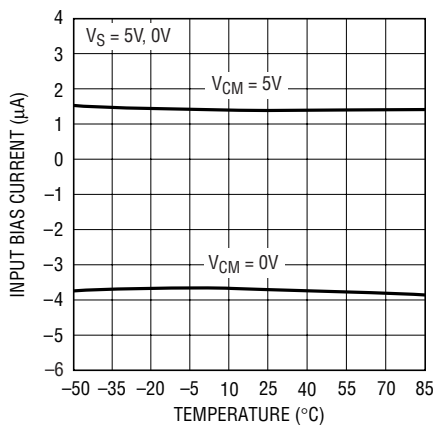

LT6202/03/04 G07

Output Saturation Voltage vs Load Current (Output Low)

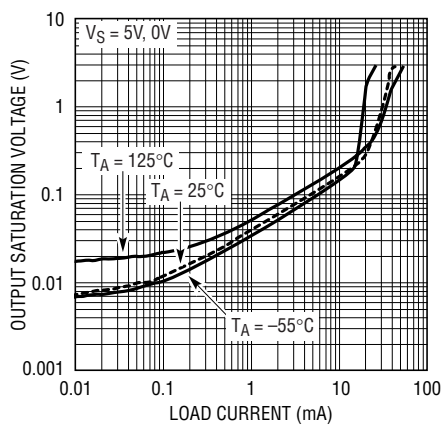

LT6202/03/04 G08

Output Saturation Voltage vs Load Current (Output High)

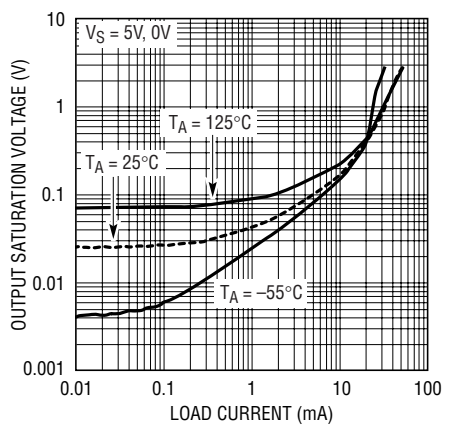

LT6202/03/04 G09

# TYPICAL PERFORMANCE CHARACTERISTICS

Minimum Supply Voltage

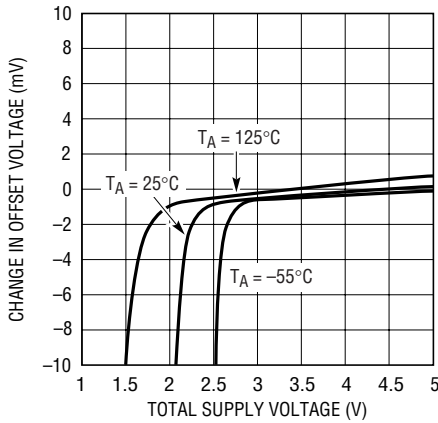

LT6202/03/04 G10

Output Short-Circuit Current vs Power Supply Voltage

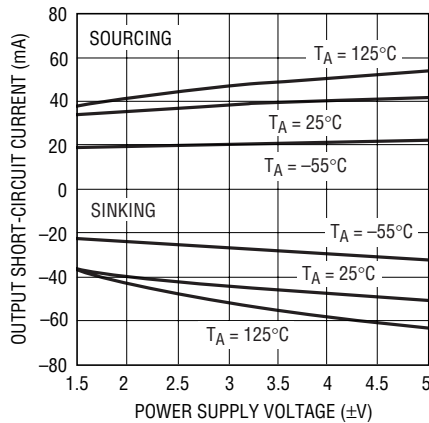

LT6202/03/04 G11

Open-Loop Gain

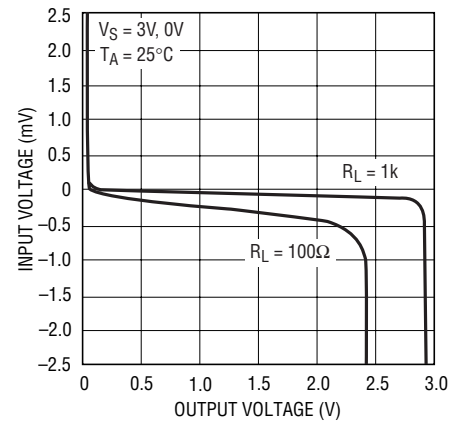

LT6202/03/04 G12

Open-Loop Gain

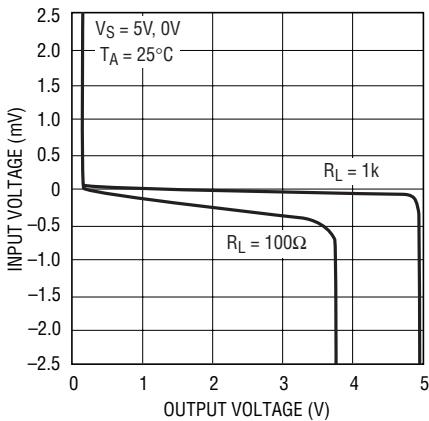

LT6202/03/04 G13

Open-Loop Gain

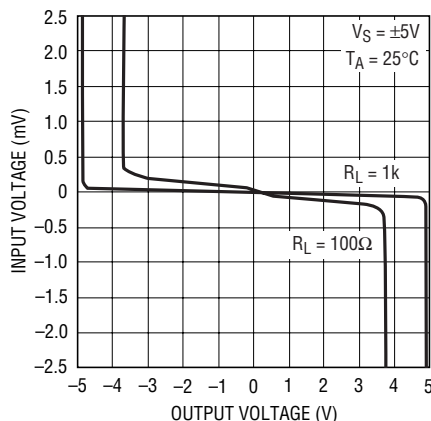

LT6202/03/04 G14

Offset Voltage vs Output Current

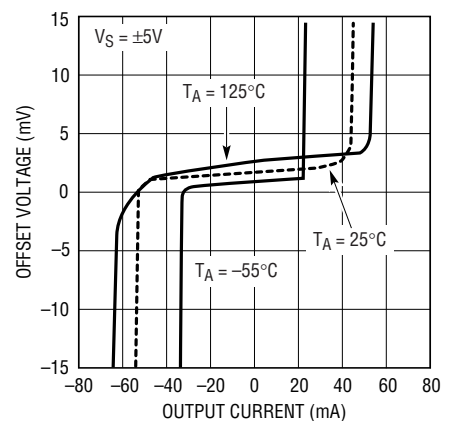

LT6202/03/04 G15

Warm-Up Drift vs Time (LT6203S8)

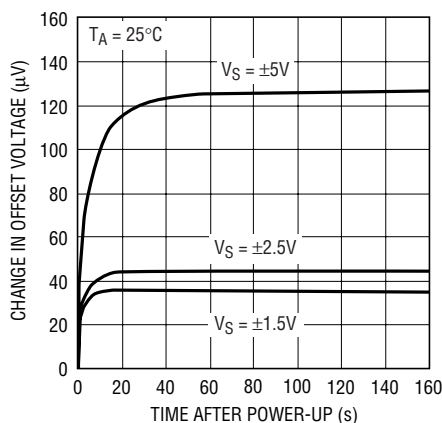

LT6202/03/04 G16

Total Noise vs Total Source Resistance

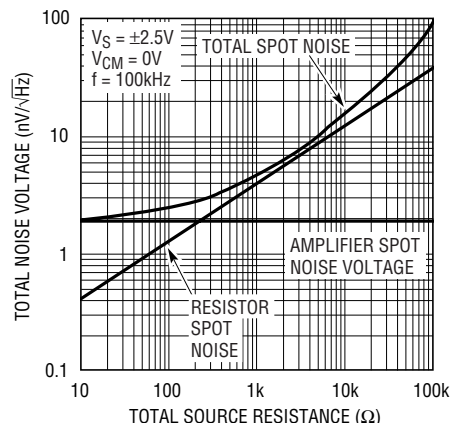

LT6202/03/04 G17

Input Noise Voltage vs Frequency

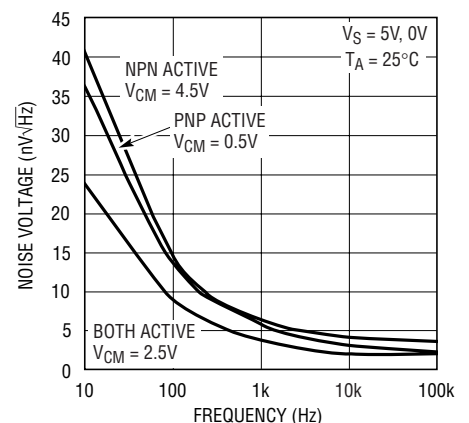

LT6202/03/04 G18

# TYPICAL PERFORMANCE CHARACTERISTICS

**Balanced Noise Current vs Frequency**

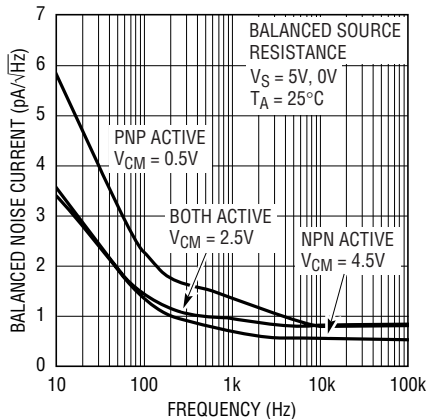

LT6202/03/04 G19

**Unbalanced Noise Current vs Frequency**

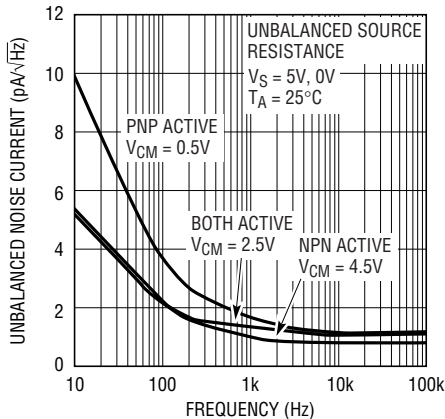

LT6202/03/04 G19.1

**0.1Hz to 10Hz Output Voltage Noise**

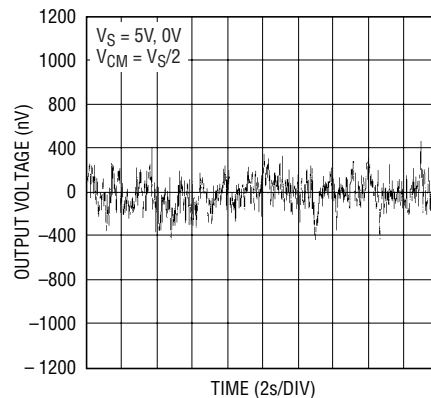

LT6202/03/04 G20

**Gain Bandwidth and Phase Margin vs Temperature**

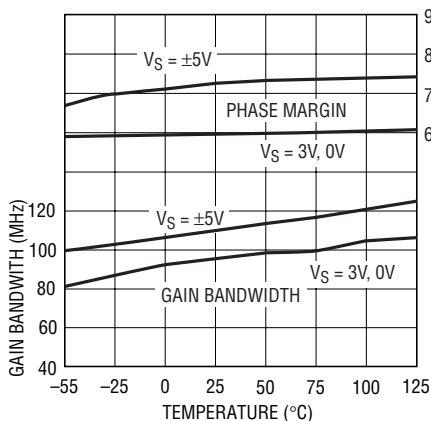

LT6202/03/04 G21

**Open-Loop Gain vs Frequency**

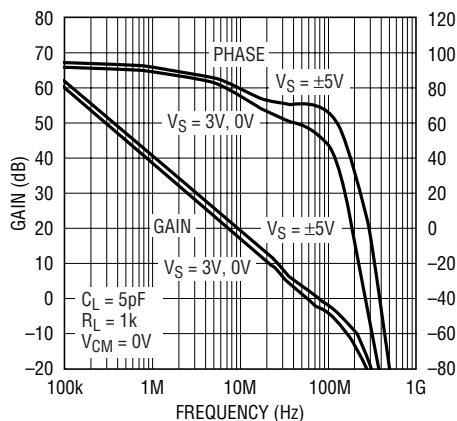

LT6202/03/04 G22

**Open-Loop Gain vs Frequency**

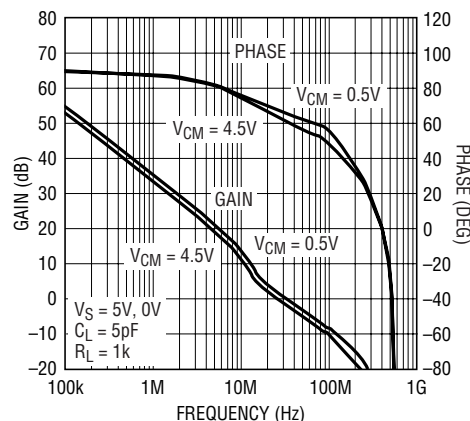

LT6202/03/04 G23

**Gain Bandwidth and Phase Margin vs Supply Voltage**

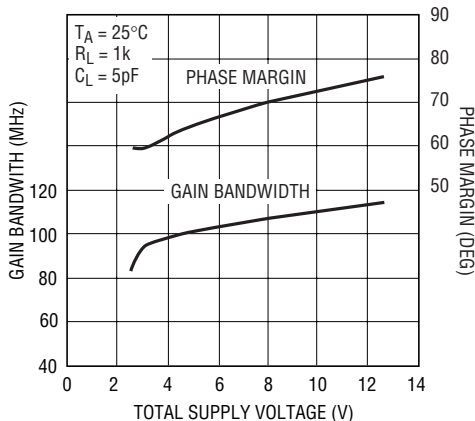

LT6202/03/04 G24

**Slew Rate vs Temperature**

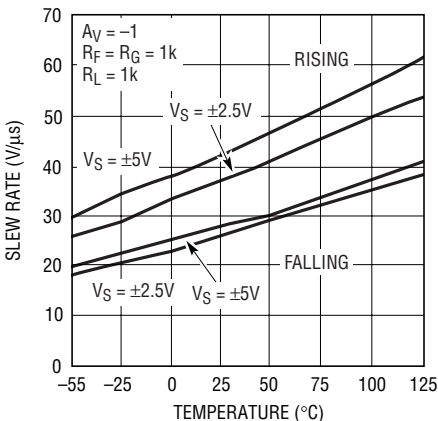

LT6202/03/04 G25

**Output Impedance vs Frequency**

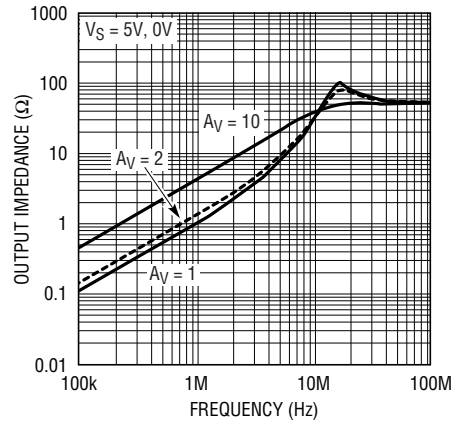

LT6202/03/04 G26

# TYPICAL PERFORMANCE CHARACTERISTICS

**Common Mode Rejection Ratio vs Frequency**

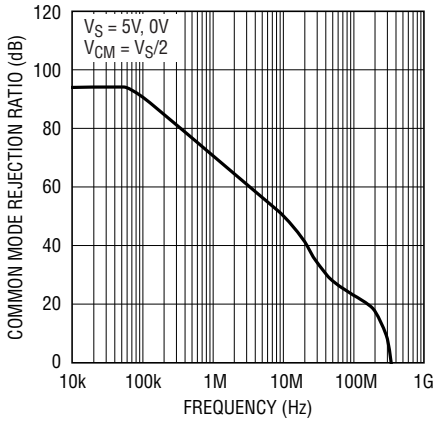

LT6202/03/04 G27

**Channel Separation vs Frequency**

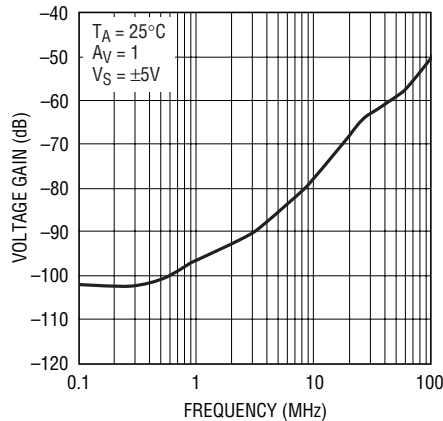

LT6202/03/04 G27.1

**Power Supply Rejection Ratio vs Frequency**

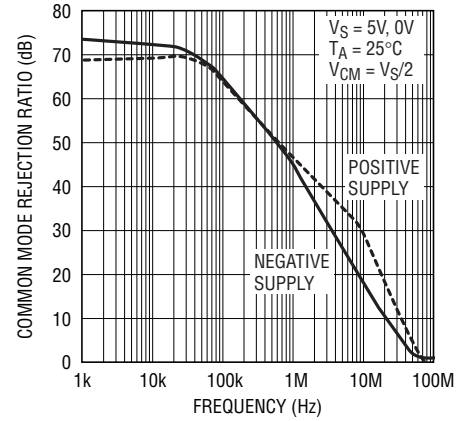

LT6202/03/04 G28

**Series Output Resistor vs Capacitive Load**

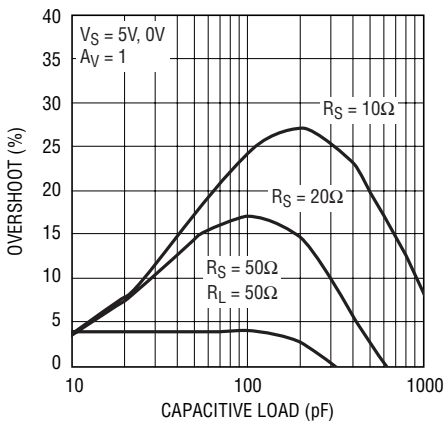

LT6202/03/04 G29

**Series Output Resistor vs Capacitive Load**

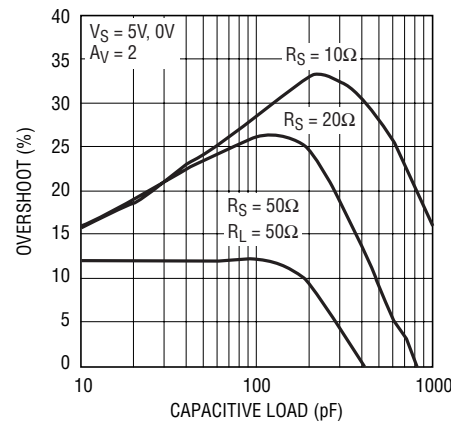

LT6202/03/04 G30

**Settling Time vs Output Step (Noninverting)**

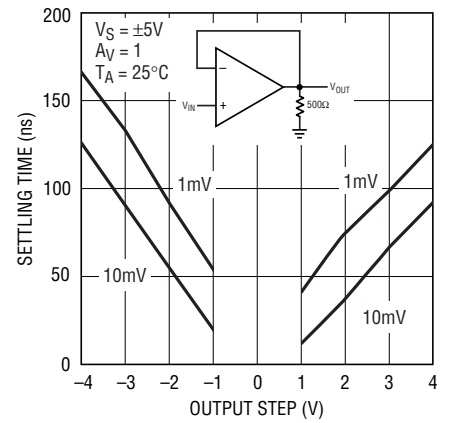

LT6202/03/04 G31

**Settling Time vs Output Step (Inverting)**

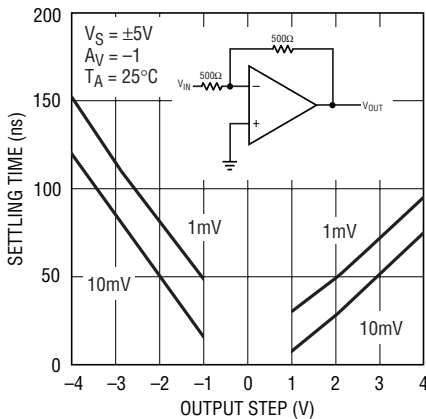

LT6202/03/04 G32

**Maximum Undistorted Output Signal vs Frequency**

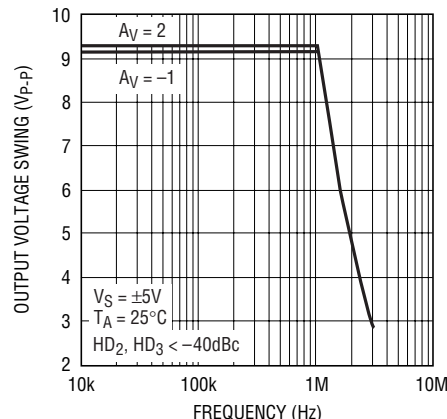

LT6202/03/04 G33

**Distortion vs Frequency**

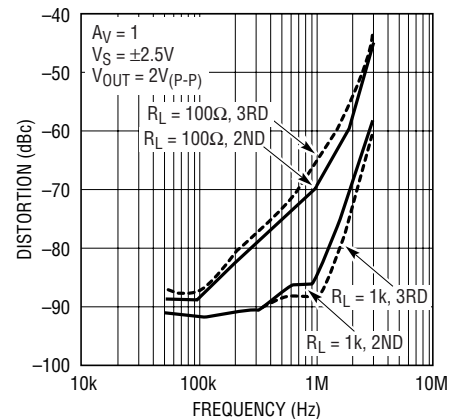

LT6202/03/04 G34

# TYPICAL PERFORMANCE CHARACTERISTICS

**Distortion vs Frequency**

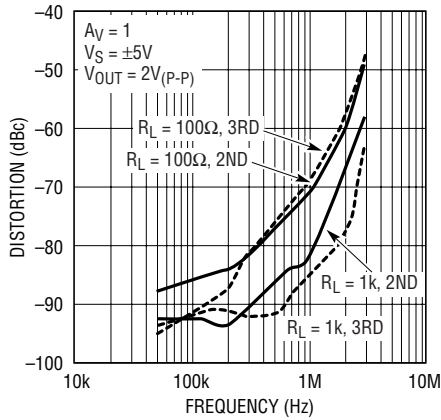

LT6202/03/04 G35

**Distortion vs Frequency**

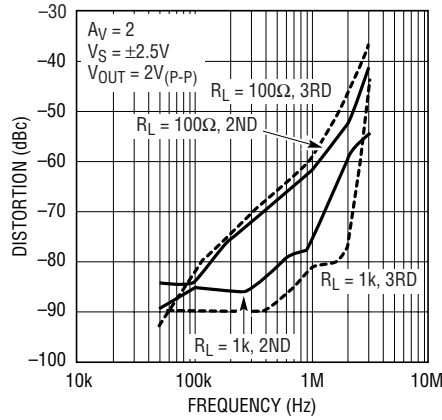

LT6202/03/04 G36

**Distortion vs Frequency**

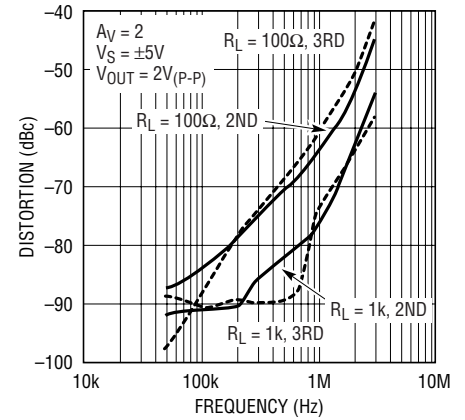

LT6202/03/04 G37

**5V Large-Signal Response**

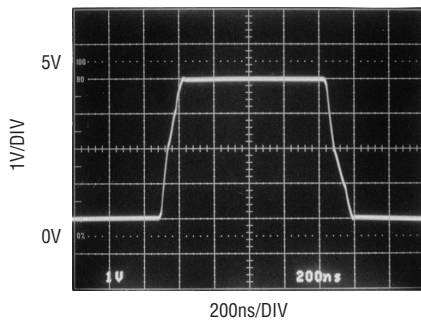

$V_S = 5V, 0V$   
 $A_V = 1$   
 $R_L = 1k$

LT6202/03/04 G38

**5V Small-Signal Response**

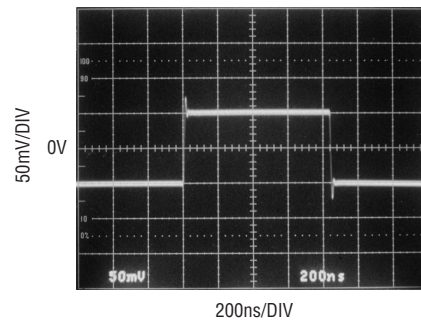

$V_S = 5V, 0V$   
 $A_V = 1$   
 $R_L = 1k$

LT6202/03/04 G39

**±5V Large-Signal Response**

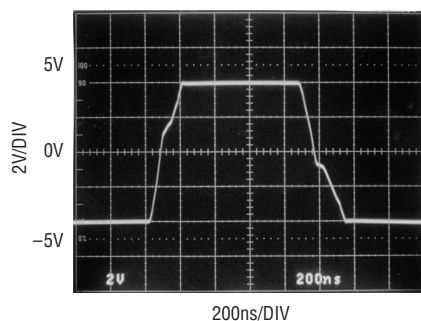

$V_S = \pm 5V$   
 $A_V = 1$   
 $R_L = 1k$

LT6202/03/04 G40

**Output-Overdrive Recovery**

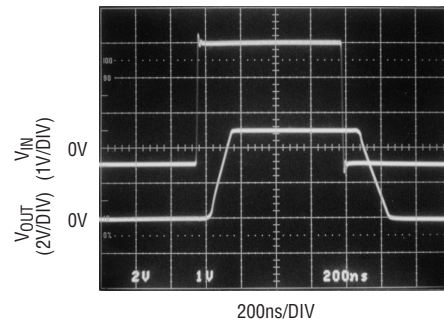

$V_S = 5V, 0V$   
 $A_V = 2$

LT6202/03/04 G41

## APPLICATIONS INFORMATION

### Amplifier Characteristics

Figure 1 shows a simplified schematic of the LT6202/LT6203/LT6204, which has two input differential amplifiers in parallel that are biased on simultaneously when the common mode voltage is at least 1.5V from either rail. This topology allows the input stage to swing from the positive supply voltage to the negative supply voltage. As the common mode voltage swings beyond  $V_{CC} - 1.5V$ , current source  $I_1$  saturates and current in Q1/Q4 is zero. Feedback is maintained through the Q2/Q3 differential amplifier, but with an input  $g_m$  reduction of 1/2. A similar effect occurs with  $I_2$  when the common mode voltage swings within 1.5V of the negative rail. The effect of the  $g_m$  reduction is a shift in the  $V_{OS}$  as  $I_1$  or  $I_2$  saturate.

Input bias current normally flows out of the + and – inputs. The magnitude of this current increases when the input common mode voltage is within 1.5V of the negative rail, and only Q1/Q4 are active. The polarity of this current reverses when the input common mode voltage is within 1.5V of the positive rail and only Q2/Q3 are active.

The second stage is a folded cascode and current mirror that converts the input stage differential signals to a single ended output. Capacitor  $C_1$  reduces the unity cross frequency and improves the frequency stability without degrading the gain bandwidth of the amplifier. The differential drive generator supplies current to the output transistors that swing from rail-to-rail.

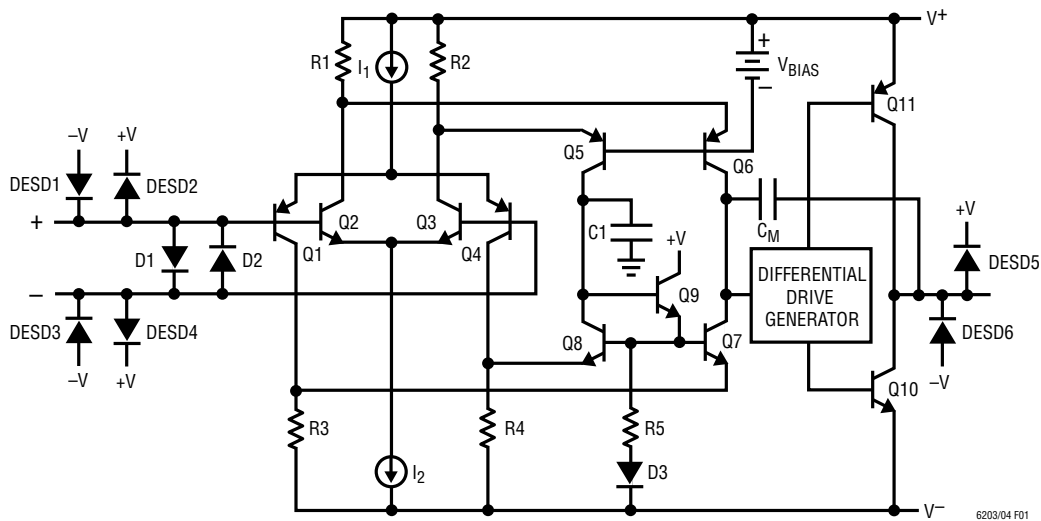

Figure 1. Simplified Schematic



## APPLICATIONS INFORMATION

### Input Protection

There are back-to-back diodes, D1 and D2, across the + and – inputs of these amplifiers to limit the differential input voltage to  $\pm 0.7V$ . The inputs of the LT6202/LT6203/LT6304 do not have internal resistors in series with the input transistors. This technique is often used to protect the input devices from over voltage that causes excessive currents to flow. The addition of these resistors would significantly degrade the low noise voltage of these amplifiers. For instance, a  $100\Omega$  resistor in series with each input would generate  $1.8nV/\sqrt{Hz}$  of noise, and the total amplifier noise voltage would rise from  $1.9nV/\sqrt{Hz}$  to  $2.6nV/\sqrt{Hz}$ . Once the input differential voltage exceeds  $\pm 0.7V$ , steady state current conducted through the protection diodes should be limited to  $\pm 40mA$ . This implies  $25\Omega$  of protection resistance per volt of continuous overdrive beyond  $\pm 0.7V$ . The input diodes are rugged enough to handle transient currents due to amplifier slew rate overdrive or momentary clipping without these resistors.

Figure 2 shows the input and output waveforms of the amplifier driven into clipping while connected in a gain of  $A_V = 1$ . When the input signal goes sufficiently beyond the power supply rails, the input transistors will saturate. When saturation occurs, the amplifier loses a stage of phase inversion and the output tries to change states. Diodes D1 and D2 forward bias and hold the output within

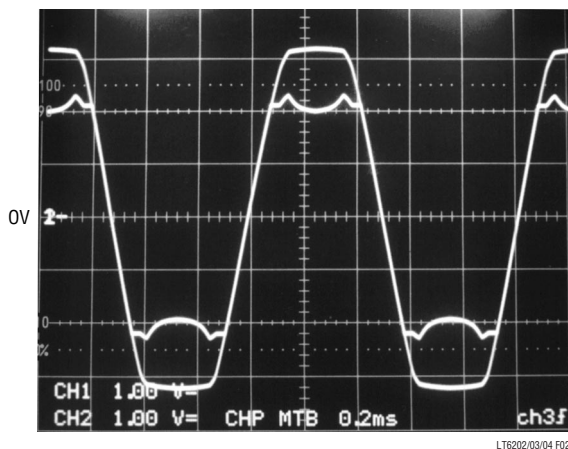

Figure 2.  $V_S = \pm 2.5V$ ,  $A_V = 1$  with Large Overdrive

a diode drop of the input signal. In this photo, the input signal generator is clipping at  $\pm 35mA$ , and the output transistors supply this generator current through the protection diodes.

With the amplifier connected in a gain of  $A_V \geq 2$ , the output can invert with very heavy input overdrive. To avoid this inversion, limit the input overdrive to  $0.5V$  beyond the power supply rails.

### ESD

The LT6202/LT6203/LT6204 have reverse-biased ESD protection diodes on all inputs and outputs as shown in Figure 1. If these pins are forced beyond either supply, unlimited current will flow through these diodes. If the current is transient and limited to one hundred milliamps or less, no damage to the device will occur.

### Noise

The noise voltage of the LT6202/LT6203/LT6204 is equivalent to that of a  $225\Omega$  resistor, and for the lowest possible noise it is desirable to keep the source and feedback resistance at or below this value, i.e.  $R_S + R_G \parallel R_{FB} \leq 225\Omega$ . With  $R_S + R_G \parallel R_{FB} = 225\Omega$  the total noise of the amplifier is:  $e_n = \sqrt{(1.9nV)^2 + (1.9nV)^2} = 2.7nV$ . Below this resistance value, the amplifier dominates the noise, but in the resistance region between  $225\Omega$  and approximately  $10k\Omega$ , the noise is dominated by the resistor thermal noise. As the total resistance is further increased, beyond  $10k$ , the noise current multiplied by the total resistance eventually dominates the noise.

The product of  $e_n \cdot \sqrt{I_{SUPPLY}}$  is an interesting way to gauge low noise amplifiers. Many low noise amplifiers with low  $e_n$  have high  $I_{SUPPLY}$  current. In applications that require low noise with the lowest possible supply current, this product can prove to be enlightening. The LT6202/LT6203/LT6204 have an  $e_n \cdot \sqrt{I_{SUPPLY}}$  product of 3.2 per amplifier, yet it is common to see amplifiers with similar noise specifications have an  $e_n \cdot \sqrt{I_{SUPPLY}}$  product of 4.7 to 13.5.

For a complete discussion of amplifier noise, see the LT1028 data sheet.



## TYPICAL APPLICATIONS

### Low Noise, Low Power 1MΩ AC Photodiode Transimpedance Amplifier

Figure 3 shows the LT6202 applied as a transimpedance amplifier (TIA). The LT6202 forces the BF862 ultralow-noise JFET source to 0V, with R3 ensuring that the JFET has an  $I_{DRAIN}$  of 1mA. The JFET acts as a source follower, buffering the input of the LT6202 and making it suitable for the high impedance feedback elements R1 and R2. The BF862 has a minimum  $I_{DSS}$  of 10mA and a pinchoff voltage between  $-0.3V$  and  $-1.2V$ . The JFET gate and the LT6202

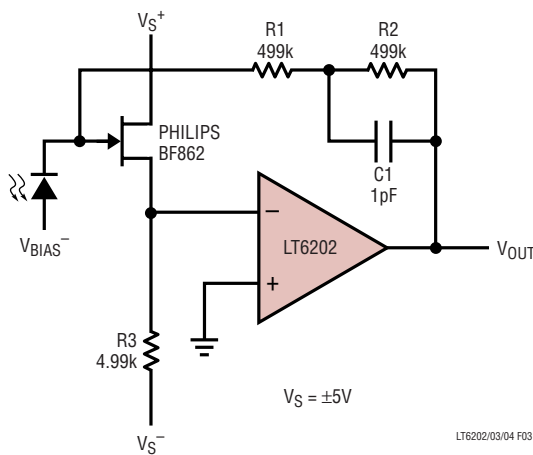

Figure 3. Low Noise, Low Power 1MΩ AC Photodiode Transimpedance Amplifier

output therefore sit at a point slightly higher than one pinchoff voltage below ground (typically about  $-0.6V$ ). When the photodiode is illuminated, the current must come from the LT6202's output through R1 and R2, as in a normal TIA. Amplifier input noise density and gain-bandwidth product were measured at  $2.4nV/Hz$  and  $100MHz$ , respectively. Note that because the JFET has a high  $g_m$ , approximately  $1/80\Omega$ , its attenuation looking into R3 is only about 2%. Gain-bandwidth product was measured at  $100MHz$  and the closed-loop bandwidth using a  $3pF$  photodiode was approximately  $1.4MHz$ .

### Precision Low Noise, Low Power, 1MΩ Photodiode Transimpedance Amplifier

Figure 4 shows the LT6202 applied as a transimpedance amplifier (TIA), very similar to that shown in Figure 3. In this case, however, the JFET is not allowed to dictate the DC-bias conditions. Rather than being grounded, the LT6202's noninverting input is driven by the LTC2050 to the exact state necessary for zero JFET gate voltage. The noise performance is nearly identical to that of the circuit in Figure 3, with the additional benefit of excellent DC performance. Input offset was measured at under  $200\mu V$  and output noise was within  $2mV_{P-P}$  over a  $20MHz$  bandwidth.

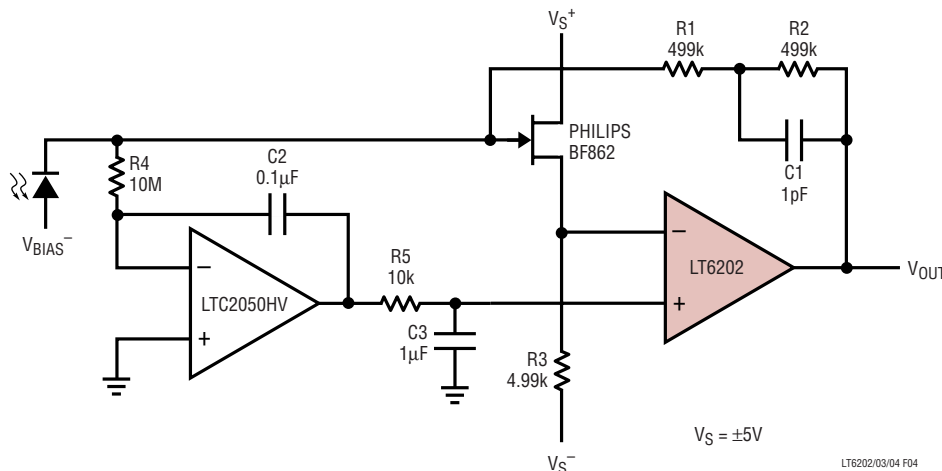

Figure 4. Precision Low Noise, Low Power Transimpedance Amplifier

## TYPICAL APPLICATIONS

### Single-Supply 16-Bit ADC Driver

Figure 5 shows the LT6203 driving an LTC1864 unipolar 16-bit A/D converter. The bottom half of the LT6203 is in a gain-of-one configuration and buffers the 0V negative full-scale signal  $V_{LOW}$  into the negative input of the LTC1864. The top half of the LT6203 is in a gain-of-ten configuration referenced to the buffered voltage  $V_{LOW}$  and drives the positive input of the LTC1864. The input range of the LTC1864 is 0V to 5V, but for best results the input range of  $V_{IN}$  should be from  $V_{LOW}$  (about 0.4V) to about 0.82V. Figure 6 shows an FFT obtained with a 10.1318kHz coherent input waveform, from 8192 samples with no windowing or averaging. Spurious free dynamic range is seen to be about 100dB.

Although the LTC1864 has a sample rate far below the gain bandwidth of the LT6203, using this amplifier is not necessarily a case of overkill. The designer is reminded that A/D converters have sample apertures that are vanishingly small (ideally, infinitesimally small) and make demands on the upstream circuitry far in excess of what is implied by the innocent-looking sample rate. In addition, when an A/D converter takes a sample, it applies a small capacitor to its inputs with a fair amount of glitch energy and expects the voltage on the capacitor to settle to the true value very quickly. Finally, the LTC1864 has a 20MHz analog input bandwidth and can be used in undersampling applications, again requiring a source bandwidth higher than Nyquist.

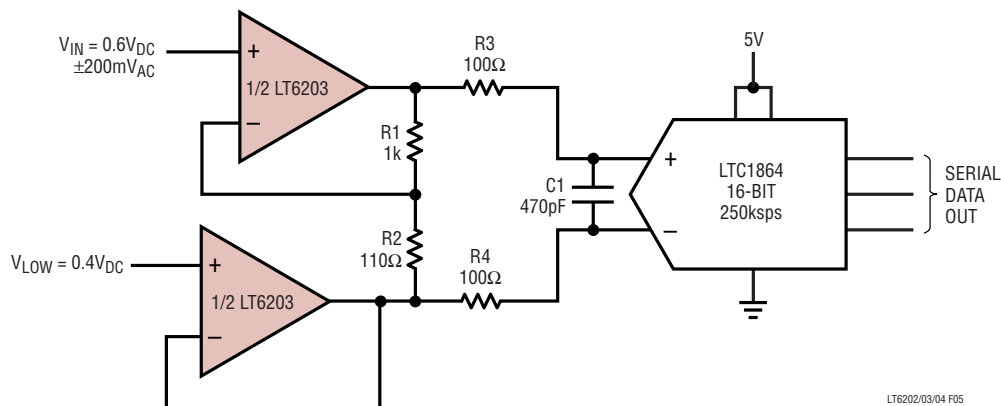

Figure 5. Single-Supply 16-Bit ADC Driver

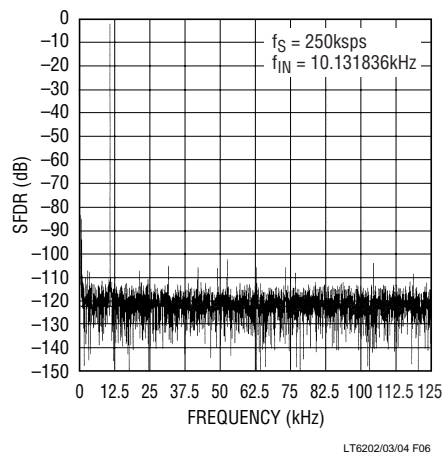
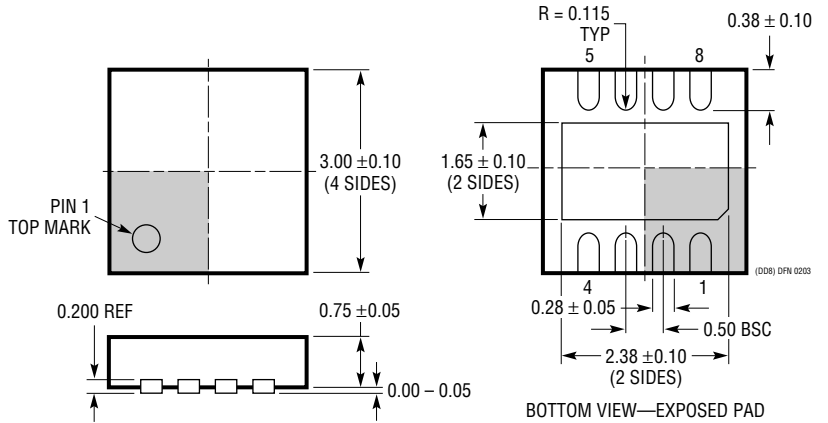
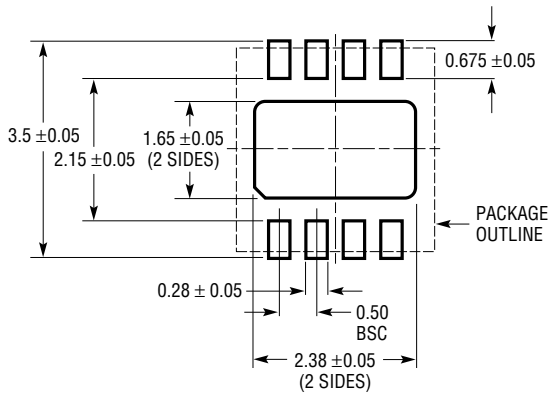

Figure 6. FFT Showing 100dB SFDR

# PACKAGE DESCRIPTION

## DD Package 8-Lead Plastic DFN (3mm × 3mm) (Reference LTC DWG # 05-08-1698)



## GN Package 16-Lead Plastic SSOP (Narrow .150 Inch) (Reference LTC DWG # 05-08-1641)

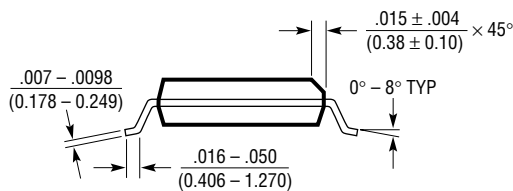
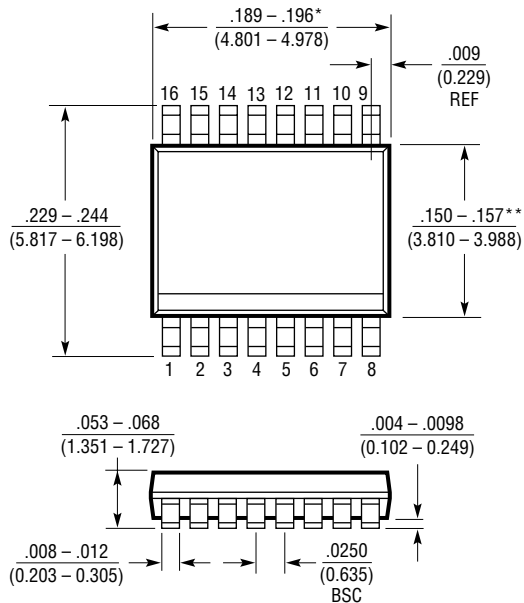
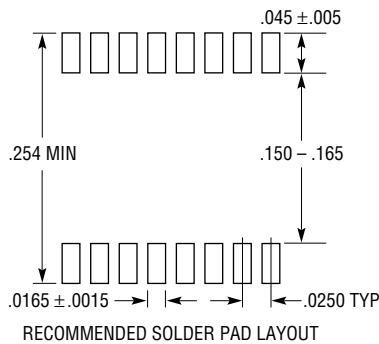

- NOTE:
1. CONTROLLING DIMENSION: INCHES
  2. DIMENSIONS ARE IN  $\frac{\text{INCHES}}{\text{MILLIMETERS}}$
  3. DRAWING NOT TO SCALE
- \*DIMENSION DOES NOT INCLUDE MOLD FLASH. MOLD FLASH SHALL NOT EXCEED 0.006" (0.152mm) PER SIDE
- \*\*DIMENSION DOES NOT INCLUDE INTERLEAD FLASH. INTERLEAD FLASH SHALL NOT EXCEED 0.010" (0.254mm) PER SIDE

GN16 (SSOP) 0502

**PACKAGE DESCRIPTION**

**MS8 Package**  
**8-Lead Plastic MSOP**  
 (Reference LTC DWG # 05-08-1660)

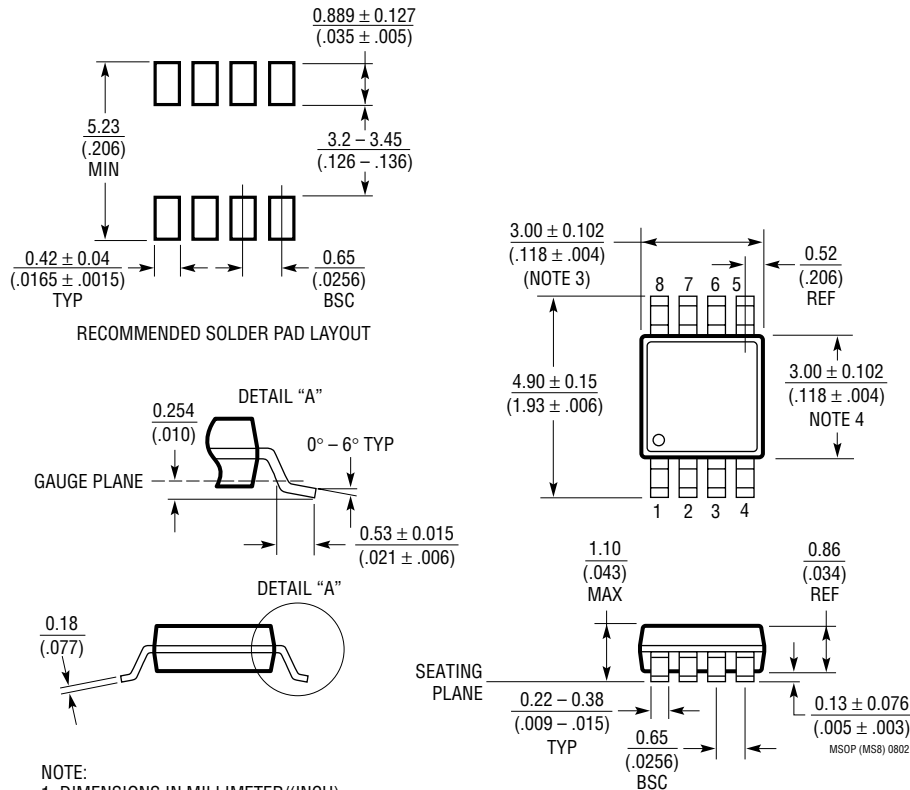

- NOTE:
1. DIMENSIONS IN MILLIMETER/(INCH)
  2. DRAWING NOT TO SCALE
  3. DIMENSION DOES NOT INCLUDE MOLD FLASH, PROTRUSIONS OR GATE BURRS.  
MOLD FLASH, PROTRUSIONS OR GATE BURRS SHALL NOT EXCEED 0.152mm (.006") PER SIDE
  4. DIMENSION DOES NOT INCLUDE INTERLEAD FLASH OR PROTRUSIONS.  
INTERLEAD FLASH OR PROTRUSIONS SHALL NOT EXCEED 0.152mm (.006") PER SIDE
  5. LEAD COPLANARITY (BOTTOM OF LEADS AFTER FORMING) SHALL BE 0.102mm (.004") MAX

**PACKAGE DESCRIPTION**

**S8 Package**  
**8-Lead Plastic Small Outline (Narrow .150 Inch)**  
 (Reference LTC DWG # 05-08-1610)

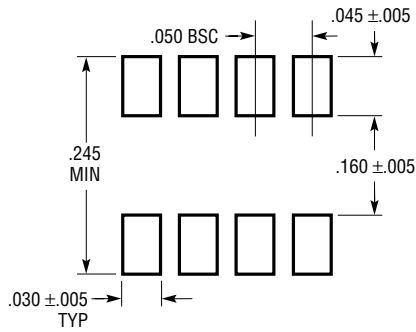

RECOMMENDED SOLDER PAD LAYOUT

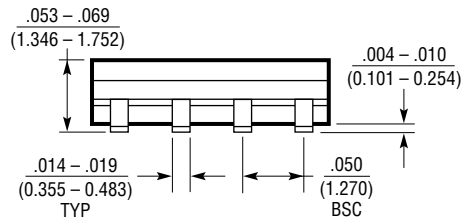
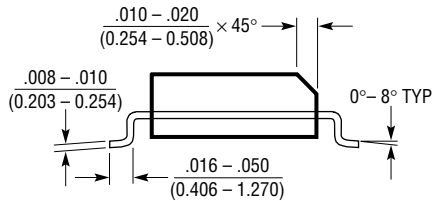
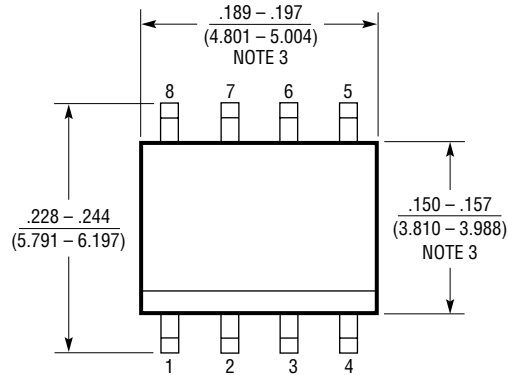

- NOTE:  
 1. DIMENSIONS IN  $\frac{\text{INCHES}}{\text{MILLIMETERS}}$   
 2. DRAWING NOT TO SCALE  
 3. THESE DIMENSIONS DO NOT INCLUDE MOLD FLASH OR PROTRUSIONS.  
 MOLD FLASH OR PROTRUSIONS SHALL NOT EXCEED .006" (0.15mm)

S08 0303

## PACKAGE DESCRIPTION

### S Package 14-Lead Plastic Small Outline (Narrow .150 Inch) (Reference LTC DWG # 05-08-1610)

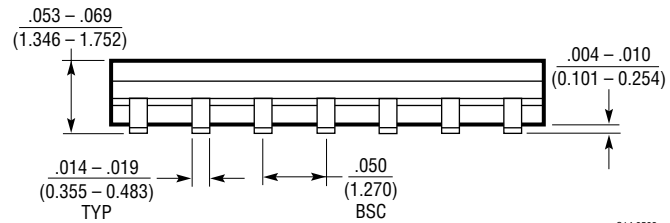
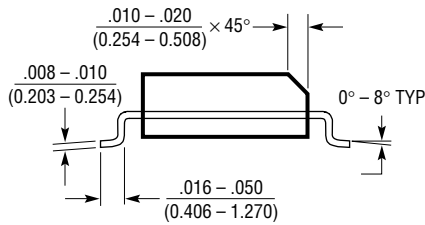
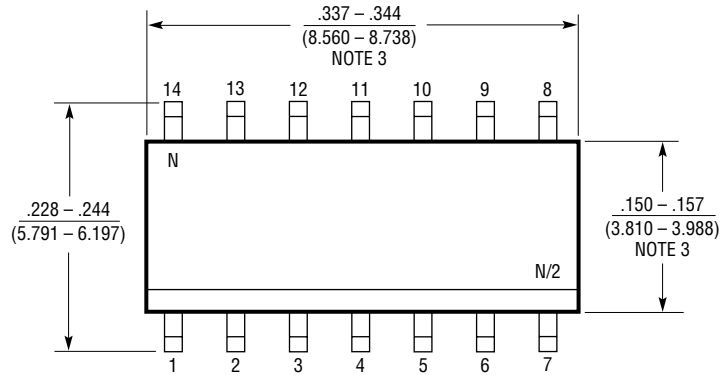
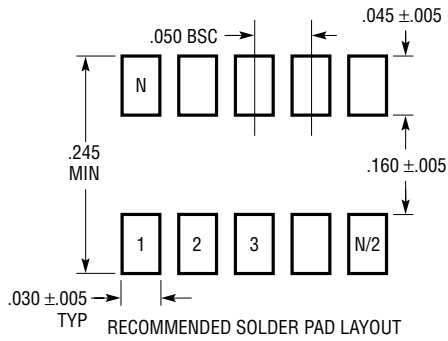

- NOTE:  
 1. DIMENSIONS IN  $\frac{\text{INCHES}}{\text{MILLIMETERS}}$   
 2. DRAWING NOT TO SCALE  
 3. THESE DIMENSIONS DO NOT INCLUDE MOLD FLASH OR PROTRUSIONS.  
 MOLD FLASH OR PROTRUSIONS SHALL NOT EXCEED .006" (0.15mm)

S14 0502

**PACKAGE DESCRIPTION**

**S5 Package**  
**5-Lead Plastic TSOT-23**  
 (Reference LTC DWG # 05-08-1635)

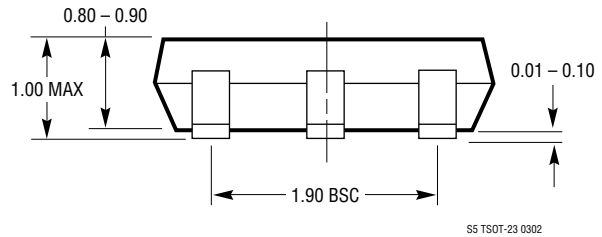
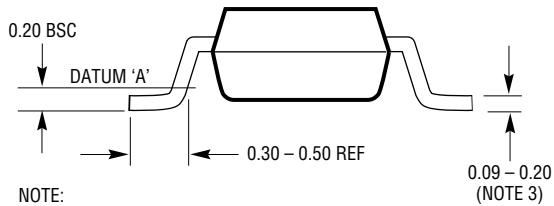
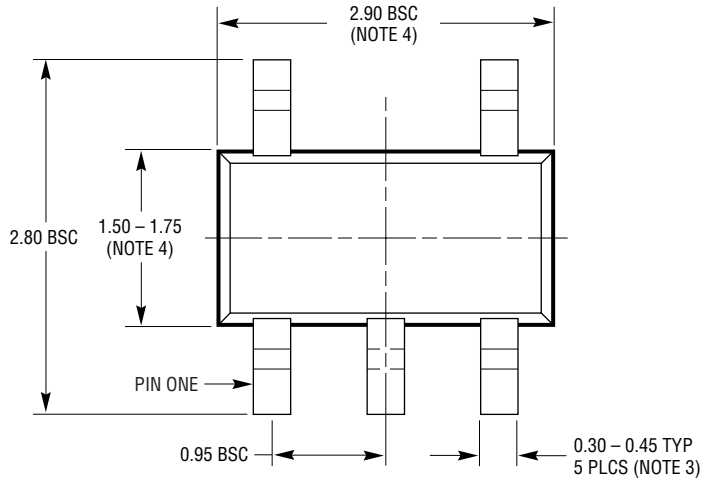
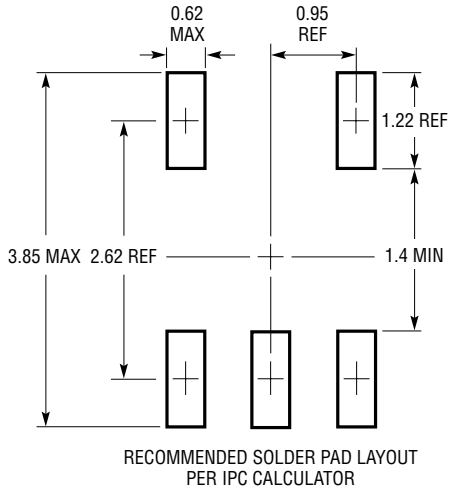

- NOTE:
1. DIMENSIONS ARE IN MILLIMETERS
  2. DRAWING NOT TO SCALE
  3. DIMENSIONS ARE INCLUSIVE OF PLATING
  4. DIMENSIONS ARE EXCLUSIVE OF MOLD FLASH AND METAL BURR
  5. MOLD FLASH SHALL NOT EXCEED 0.254mm
  6. JEDEC PACKAGE REFERENCE IS MO-193

S5 TSOT-23 0302

**TYPICAL APPLICATION**

**Low Noise Differential Amplifier with Gain Adjust and Common Mode Control**

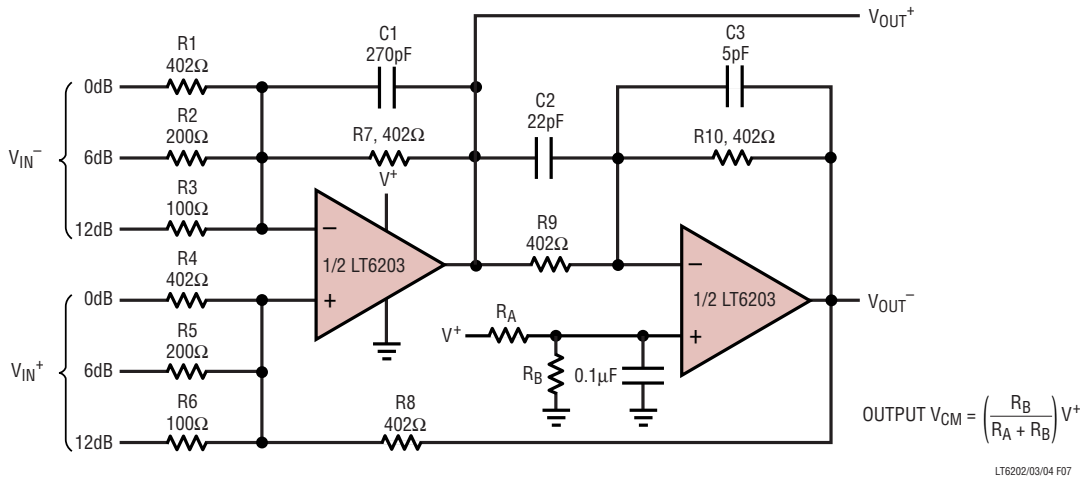

**Low Noise Differential Amplifier Frequency Response**

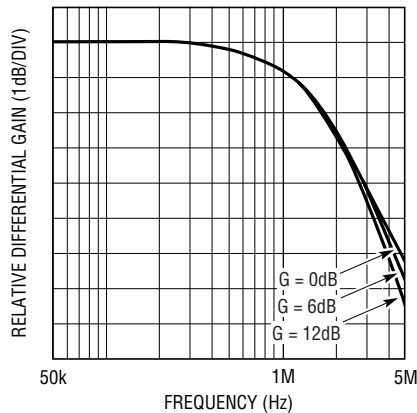

**RELATED PARTS**

| PART NUMBER          | DESCRIPTION   | COMMENTS   |
|----------------------|---|--|
| LT1028               | Single, Ultralow Noise 50MHz Op Amp                   | 1.1nV/√Hz  |
| LT1677               | Single, Low Noise Rail-to-Rail Amplifier              | 3V Operation, 2.5mA, 4.5nV/√Hz, 60µV Max V <sub>OS</sub>       |
| LT1722/LT1723/LT1724 | Single/Dual/Quad Low Noise Precision Op Amps          | 70V/µs Slew Rate, 400µV Max V <sub>OS</sub> , 3.8nV/√Hz, 3.7mA |
| LT1800/LT1801/LT1802 | Single/Dual/Quad Low Power 80MHz Rail-to-Rail Op Amps | 8.5nV/√Hz, 2mA Max Supply                                      |
| LT1806/LT1807        | Single/Dual, Low Noise 325MHz Rail-to-Rail Amplifiers | 2.5V Operation, 550µV Max V <sub>OS</sub> , 3.5nV/√Hz          |
| LT6200               | Single Ultralow Noise Rail-to-Rail Amplifier          | 0.95nV/√Hz, 165MHz Gain Bandwidth                              |