

ADM485

FEATURES

- Meets EIA RS-485 Standard
- 5 Mb/s Data Rate
- Single +5 V Supply
- 7 V to +12 V Bus Common-Mode Range
- High Speed, Low Power BiCMOS
- Thermal Shutdown Protection
- Short Circuit Protection
- Zero Skew Driver
- Driver Propagation Delay: 10 ns
- Receiver Propagation Delay: 25 ns
- High Z Outputs with Power Off
- Superior Upgrade for LTC485

APPLICATIONS

- Low Power RS-485 Systems
- DTE-DCE Interface
- Packet Switching
- Local Area Networks
- Data Concentration
- Data Multiplexers
- Integrated Services Digital Network (ISDN)

FUNCTIONAL BLOCK DIAGRAM

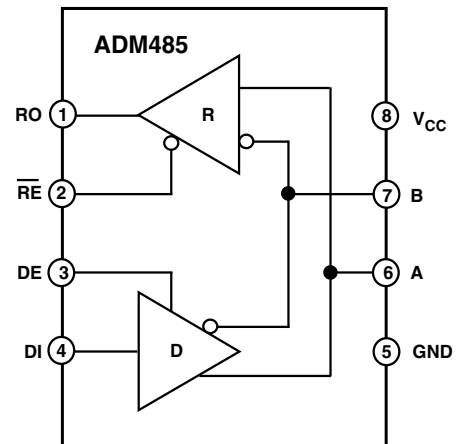

PRODUCT DESCRIPTION

The ADM485 is a differential line transceiver suitable for high speed bidirectional data communication on multipoint bus transmission lines. It is designed for balanced data transmission and complies with both EIA Standards RS-485 and RS-422. The part contains a differential line driver and a differential line receiver. Both the driver and the receiver may be enabled independently. When disabled, the outputs are tristated.

The ADM485 operates from a single +5 V power supply. Excessive power dissipation caused by bus contention or by output shorting is prevented by a thermal shutdown circuit. This feature forces the driver output into a high impedance state if during fault conditions a significant temperature increase is detected in the internal driver circuitry.

Up to 32 transceivers may be connected simultaneously on a bus, but only one driver should be enabled at any time. It is important, therefore, that the remaining disabled drivers do not load the bus. To ensure this, the ADM485 driver features high output impedance when disabled and also when powered down.

This minimizes the loading effect when the transceiver is not being utilized. The high impedance driver output is maintained over the entire common-mode voltage range from -7 V to +12 V.

The receiver contains a fail safe feature which results in a logic high output state if the inputs are unconnected (floating).

The ADM485 is fabricated on BiCMOS, an advanced mixed technology process combining low power CMOS with fast switching bipolar technology. All inputs and outputs contain protection against ESD; all driver outputs feature high source and sink current capability. An epitaxial layer is used to guard against latch-up.

The ADM485 features extremely fast switching speeds. Minimal driver propagation delays permit transmission at data rates up to 5 Mb/s while low skew minimizes EMI interference.

The part is fully specified over the commercial and industrial temperature range and is available in an 8-lead DIL/SOIC package.

REV. A

Information furnished by Analog Devices is believed to be accurate and reliable. However, no responsibility is assumed by Analog Devices for its use, nor for any infringements of patents or other rights of third parties which may result from its use. No license is granted by implication or otherwise under any patent or patent rights of Analog Devices.

One Technology Way, P.O. Box 9106, Norwood, MA 02062-9106, U.S.A.
 Tel: 781/329-4700 World Wide Web Site: <http://www.analog.com>
 Fax: 781/326-8703 © Analog Devices, Inc., 2000

ADM485—SPECIFICATIONS (V_{CC} = +5 V ± 5%. All specifications T_{MIN} to T_{MAX} unless otherwise noted)

Parameter	Min	Typ	Max	Units	Test Conditions/Comments
DRIVER					
Differential Output Voltage, V _{OD}			5.0	V	R = ∞, Figure 1
	2.0		5.0	V	V _{CC} = 5 V, R = 50 Ω (RS-422), Figure 1
	1.5		5.0	V	R = 27 Ω (RS-485), Figure 1
V _{OD3}	1.5		5.0	V	V _{TST} = -7 V to +12 V, Figure 2
Δ V _{OD} for Complementary Output States			0.2	V	R = 27 Ω or 50 Ω, Figure 1
Common-Mode Output Voltage V _{OC}			3	V	R = 27 Ω or 50 Ω, Figure 1
Δ V _{OC} for Complementary Output States			0.2	V	R = 27 Ω or 50 Ω
Output Short Circuit Current (V _{OUT} = High)	35		250	mA	-7 V ≤ V _O ≤ +12 V
Output Short Circuit Current (V _{OUT} = Low)	35		250	mA	-7 V ≤ V _O ≤ +12 V
CMOS Input Logic Threshold Low, V _{INL}			0.8	V	
CMOS Input Logic Threshold High, V _{INH}	2.0			V	
Logic Input Current (DE, DI)			±1.0	μA	
RECEIVER					
Differential Input Threshold Voltage, V _{TH}	-0.2		+0.2	V	-7 V ≤ V _{CM} ≤ +12 V
Input Voltage Hysteresis, ΔV _{TH}		70		mV	V _{CM} = 0 V
Input Resistance	12			kΩ	-7 V ≤ V _{CM} ≤ +12 V
Input Current (A, B)			+1	mA	V _{IN} = 12 V
			-0.8	mA	V _{IN} = -7 V
Logic Enable Input Current (\overline{RE})			±1	μA	
CMOS Output Voltage Low, V _{OL}			0.4	V	I _{OUT} = +4.0 mA
CMOS Output Voltage High, V _{OH}	4.0			V	I _{OUT} = -4.0 mA
Short Circuit Output Current	7		85	mA	V _{OUT} = GND or V _{CC}
Tristate Output Leakage Current			±1.0	μA	0.4 V ≤ V _{OUT} ≤ +2.4 V
POWER SUPPLY CURRENT					
I _{CC} (Outputs Enabled)		1.35	2.2	mA	Outputs Unloaded, Digital Inputs = GND or V _{CC}
I _{CC} (Outputs Disabled)		0.7	1	mA	Outputs Unloaded, Digital Inputs = GND or V _{CC}

Specifications subject to change without notice.

TIMING SPECIFICATIONS (V_{CC} = +5 V ± 5%. All specifications T_{MIN} to T_{MAX} unless otherwise noted.)

Parameter	Min	Typ	Max	Units	Test Conditions/Comments
DRIVER					
Propagation Delay Input to Output T _{PLH} , T _{PHL}	2	10	15	ns	R _L Diff = 54 Ω C _{L1} = C _{L2} = 100 pF, Figure 3
Driver O/P to $\overline{O/P}$ T _{SKREW}		0	5	ns	R _L Diff = 54 Ω C _{L1} = C _{L2} = 100 pF, Figure 3
Driver Rise/Fall Time T _R , T _F		2	10	ns	R _L Diff = 54 Ω C _{L1} = C _{L2} = 100 pF, Figure 3
Driver Enable to Output Valid		10	25	ns	
Driver Disable Timing		10	25	ns	
RECEIVER					
Propagation Delay Input to Output T _{PLH} , T _{PHL}	18	25	40	ns	C _L = 15 pF, Figure 5
Skew T _{PLH} - T _{PHL}		0	5	ns	
Receiver Enable T _{EN1}		15	25	ns	Figure 6
Receiver Disable T _{EN2}		15	25	ns	Figure 6

Specifications subject to change without notice.

ABSOLUTE MAXIMUM RATINGS*

(T_A = +25°C unless otherwise noted)

V _{CC}	+7 V
Inputs	
Driver Input (DI)	-0.3 V to V _{CC} + 0.3 V
Control Inputs (DE, RE)	-0.3 V to V _{CC} + 0.3 V
Receiver Inputs (A, B)	-14 V to +14 V
Outputs	
Driver Outputs	-14 V to +14 V
Receiver Output	-0.5 V to V _{CC} + 0.5 V
Power Dissipation 8-Pin DIP	500 mW
θ _{JA} , Thermal Impedance	+130°C/W
Power Dissipation 8-Pin SOIC	450 mW
θ _{JA} , Thermal Impedance	+170°C/W
Power Dissipation 8-Pin Cerdip	500 mW
θ _{JA} , Thermal Impedance	+125°C/W
Operating Temperature Range	
Commercial (J Version)	0°C to +70°C
Industrial (A Version)	-40°C to +85°C
Storage Temperature Range	-65°C to +150°C
Lead Temperature (Soldering, 10 sec)	+300°C
Vapour Phase (60 sec)	+215°C
Infrared (15 sec)	+220°C

*Stresses above those listed under Absolute Maximum Ratings may cause permanent damage to the device. This is a stress rating only; functional operation of the device at these or any other conditions above those indicated in the operational sections of this specification is not implied. Exposure to absolute maximum ratings for extended periods may affect device reliability.

Table I. Transmitting

RE	INPUTS		OUTPUT	
	DE	DI	B	A
X	1	1	0	1
X	1	0	1	0
X	0	X	Z	Z

Table II. Receiving

RE	INPUTS		OUTPUT RO
	DE	A-B	
0	0	≥ +0.2 V	1
0	0	≤ -0.2 V	0
0	0	Inputs Open	1
1	0	X	Z

PIN FUNCTION DESCRIPTION

Pin	Mnemonic	Function
1	RO	Receiver Output. When enabled if A > B by 200 mV, then RO = High. If A < B by 200 mV, then RO = Low.
2	\overline{RE}	Receiver Output Enable. A low level enables the receiver output, RO. A high level places it in a high impedance state.
3	DE	Driver Output Enable. A high level enables the driver differential outputs, A and B. A low level places it in a high impedance state.
4	DI	Driver Input. When the driver is enabled a logic Low on DI forces A low and B high while a logic High on DI forces A high and B low.
5	GND	Ground Connection, 0 V.
6	A	Noninverting Receiver Input A/Driver Output A.
7	B	Inverting Receiver Input B/Driver Output B.
8	V _{CC}	Power Supply, 5 V ± 5%.

PIN CONFIGURATION

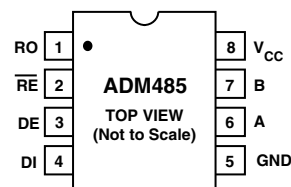

ORDERING GUIDE

Model	Temperature Range	Package Option
ADM485JN	0°C to +70°C	N-8
ADM485JR	0°C to +70°C	SO-8
ADM485AN	-40°C to +85°C	N-8
ADM485AR	-40°C to +85°C	SO-8
ADM485AQ	-40°C to +85°C	Q-8

CAUTION

ESD (electrostatic discharge) sensitive device. Electrostatic charges as high as 4000 V readily accumulate on the human body and test equipment and can discharge without detection. Although the ADM485 features proprietary ESD protection circuitry, permanent damage may occur on devices subjected to high-energy electrostatic discharges. Therefore, proper ESD precautions are recommended to avoid performance degradation or loss of functionality.



ADM485

Test Circuits

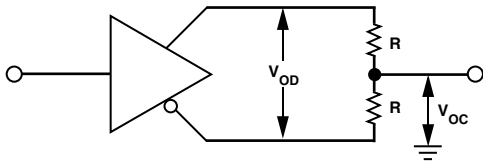

Figure 1. Driver Voltage Measurement Test Circuit

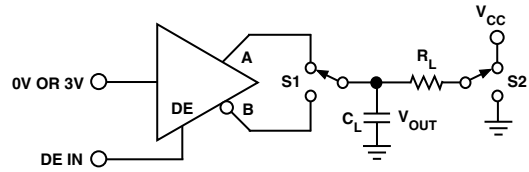

Figure 4. Driver Enable/Disable Test Circuit

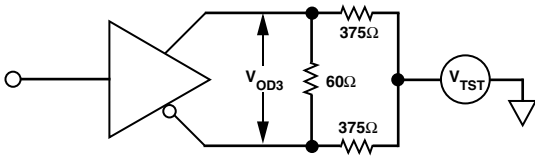

Figure 2. Driver Voltage Measurement Test Circuit 2

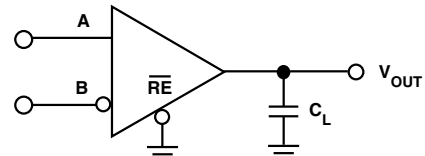

Figure 5. Receiver Propagation Delay Test Circuit

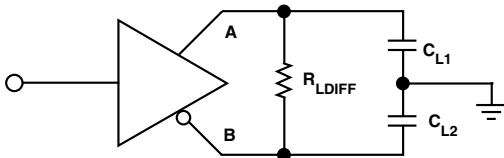

Figure 3. Driver Propagation Delay Test Circuit

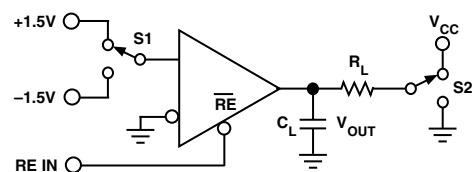

Figure 6. Receiver Enable/Disable Test Circuit

Switching Characteristics

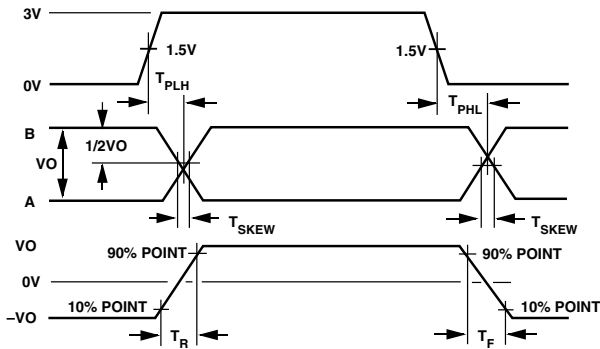

Figure 7. Driver Propagation Delay, Rise/Fall Timing

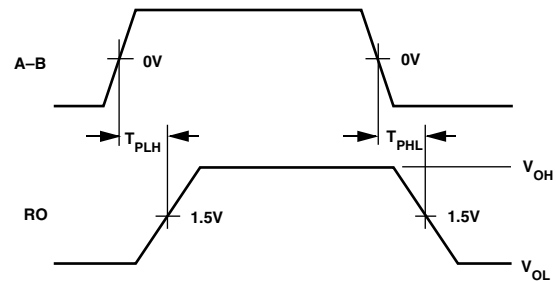

Figure 9. Receiver Propagation Delay

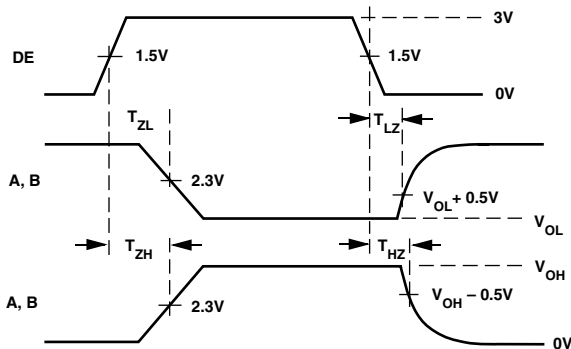

Figure 8. Driver Enable/Disable Timing

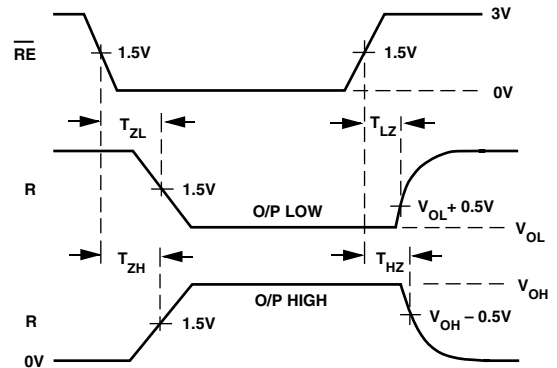

Figure 10. Receiver Enable/Disable Timing

Typical Performance Characteristics—ADM485

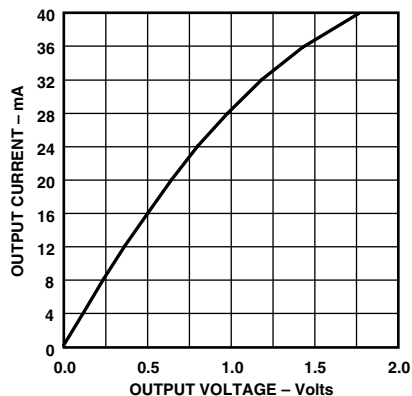

Figure 11. Receiver Output Low Voltage vs. Output Current

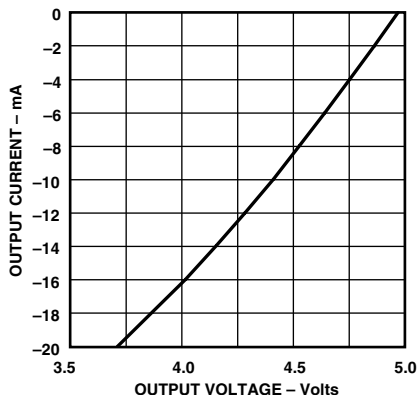

Figure 12. Receiver Output High Voltage vs. Output Current

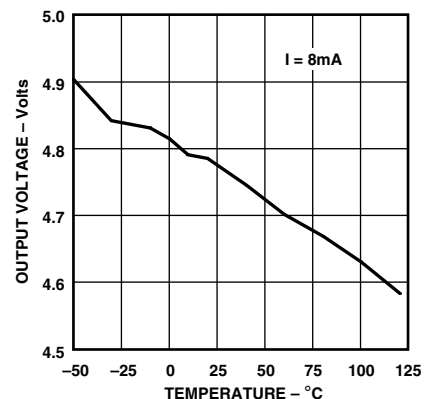

Figure 13. Receiver Output High Voltage vs. Temperature

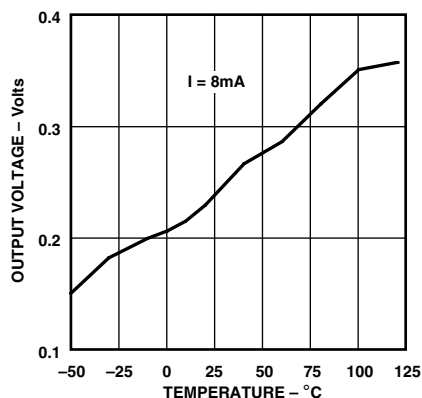

Figure 14. Receiver Output Low Voltage vs. Temperature

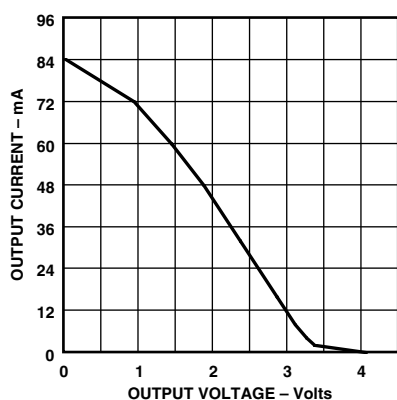

Figure 15. Driver Differential Output Voltage vs. Output Current

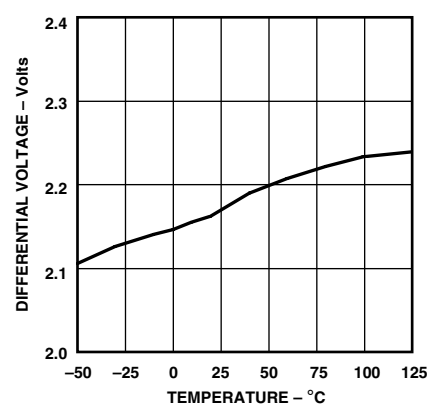

Figure 16. Driver Differential Output Voltage vs. Temperature, $R_L = 54 \Omega$

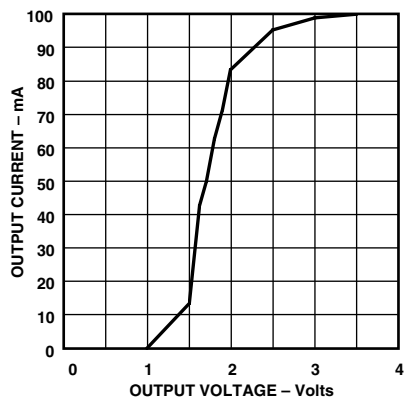

Figure 17. Driver Output Low Voltage vs. Output Current

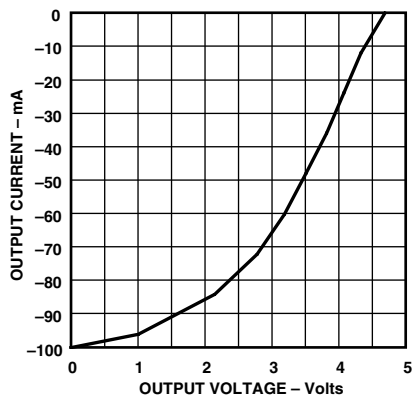

Figure 18. Driver Output High Voltage vs. Output Current

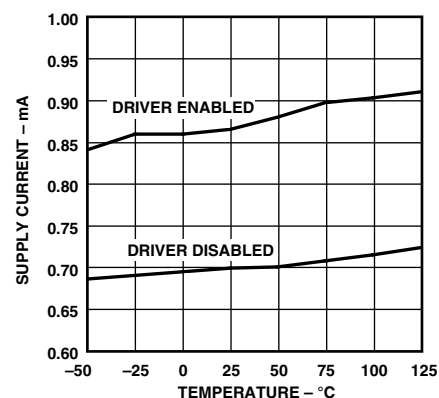

Figure 19. Supply Current vs. Temperature

ADM485—Typical Performance Characteristics

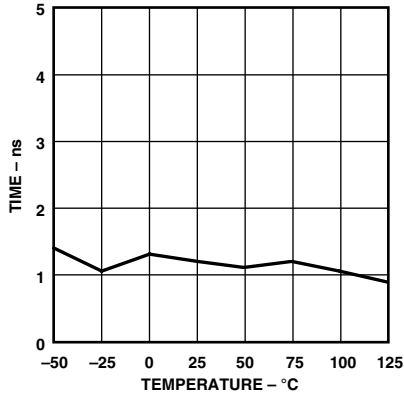

Figure 20. Receiver $t_{PLH}-t_{PHL}$ vs. Temperature

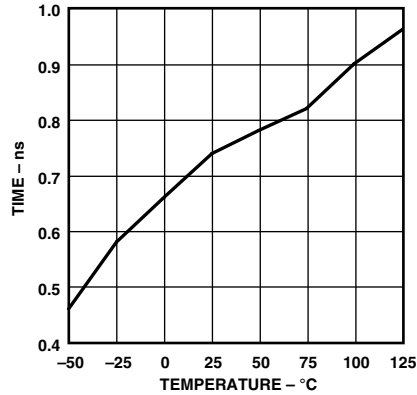

Figure 21. Driver Skew vs. Temperature

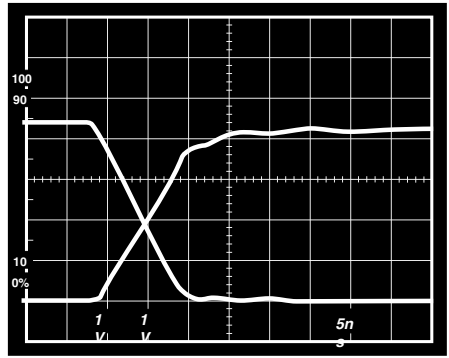

Figure 22. Unloaded Driver Differential Outputs

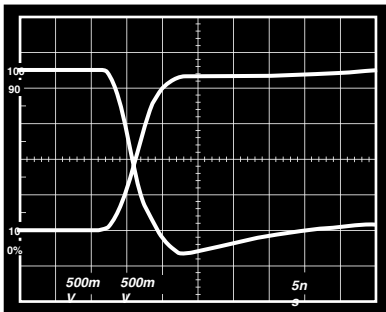

Figure 23. Loaded Driver Differential Outputs

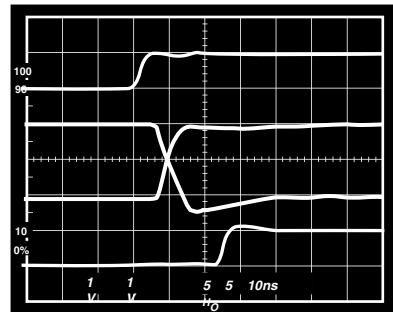

Figure 24. Driver/Receiver Propagation Delays Low to High

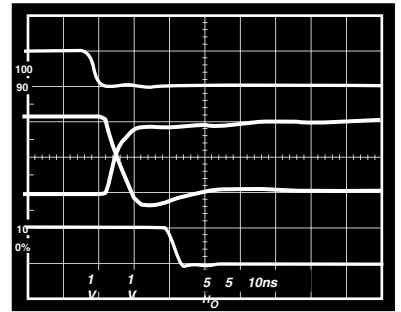

Figure 25. Driver/Receiver Propagation Delays High to Low

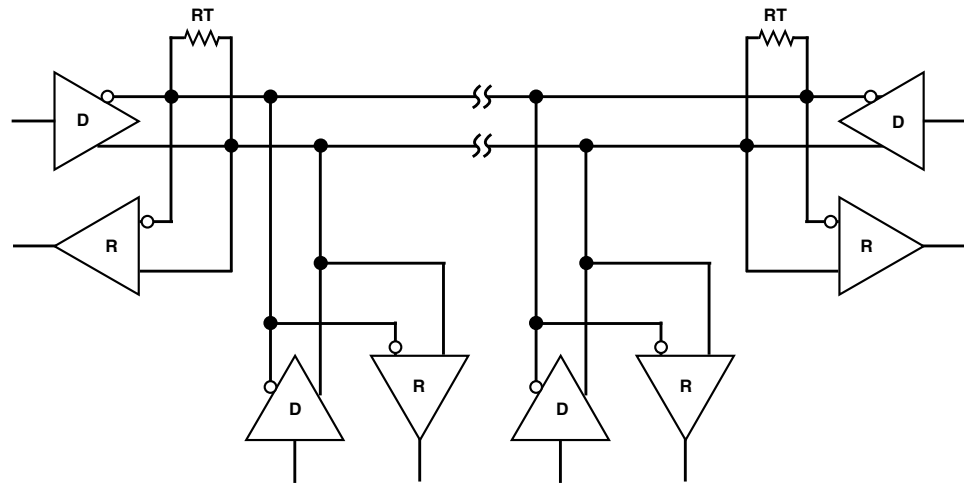

Figure 26. Typical RS-485 Network

APPLICATIONS INFORMATION

Differential Data Transmission

Differential data transmission is used to reliably transmit data at high rates over long distances and through noisy environments. Differential transmission nullifies the effects of ground shifts and noise signals which appear as common-mode voltages on the line. There are two main standards approved by the Electronics Industries Association (EIA) which specify the electrical characteristics of transceivers used in differential data transmission.

The RS-422 standard specifies data rates up to 10 MBaud and line lengths up to 4000 ft. A single driver can drive a transmission line with up to 10 receivers.

In order to cater for true multipoint communications, the RS-485 standard was defined. This standard meets or exceeds all the requirements of RS-422 but also allows for up to 32 drivers and 32 receivers to be connected to a single bus. An extended common-mode range of -7 V to $+12\text{ V}$ is defined. The most significant difference between RS-422 and RS-485 is the fact that the drivers may be disabled thereby allowing more than one (32 in fact) to be connected to a single line. Only one driver should be enabled at time, but the RS-485 standard contains additional specifications to guarantee device safety in the event of line contention.

Cable and Data Rate

The transmission line of choice for RS-485 communications is a twisted pair. Twisted pair cable tends to cancel common-mode noise and also causes cancellation of the magnetic fields generated by the current flowing through each wire, thereby, reducing the effective inductance of the pair.

The ADM485 is designed for bidirectional data communications on multipoint transmission lines. A typical application showing a multipoint transmission network is illustrated in Fig-

ure 26. An RS-485 transmission line can have as many as 32 transceivers on the bus. Only one driver can transmit at a particular time but multiple receivers may be enabled simultaneously.

As with any transmission line, it is important that reflections are minimized. This may be achieved by terminating the extreme ends of the line using resistors equal to the characteristic impedance of the line. Stub lengths of the main line should also be kept as short as possible. A properly terminated transmission line appears purely resistive to the driver.

Thermal Shutdown

The ADM485 contains thermal shutdown circuitry which protects the part from excessive power dissipation during fault conditions. Shorting the driver outputs to a low impedance source can result in high driver currents. The thermal sensing circuitry detects the increase in die temperature and disables the driver outputs. The thermal sensing circuitry is designed to disable the driver outputs when a die temperature of 150°C is reached. As the device cools, the drivers are reenabled at 140°C .

Propagation Delay

The ADM485 features very low propagation delay ensuring maximum baud rate operation. The driver is well balanced ensuring distortion free transmission.

Another important specification is a measure of the skew between the complementary outputs. Excessive skew impairs the noise immunity of the system and increases the amount of electromagnetic interference (EMI).

Receiver Open-Circuit Fail Safe

The receiver input includes a fail-safe feature which guarantees a logic high on the receiver when the inputs are open circuit or floating.

Table III. Comparison of RS-422 and RS-485 Interface Standards

Specification	RS-422	RS-485
Transmission Type	Differential	Differential
Maximum Cable Length	4000 ft.	4000 ft.
Minimum Driver Output Voltage	$\pm 2\text{ V}$	$\pm 1.5\text{ V}$
Driver Load Impedance	$100\ \Omega$	$54\ \Omega$
Receiver Input Resistance	$4\ \text{k}\Omega$ min	$12\ \text{k}\Omega$ min
Receiver Input Sensitivity	$\pm 200\ \text{mV}$	$\pm 200\ \text{mV}$
Receiver Input Voltage Range	-7 V to $+7\text{ V}$	-7 V to $+12\text{ V}$
No of Drivers/Receivers Per Line	1/10	32/32

OUTLINE DIMENSIONS

Dimensions shown in inches and (mm).

8-Lead SOIC (SO-8)

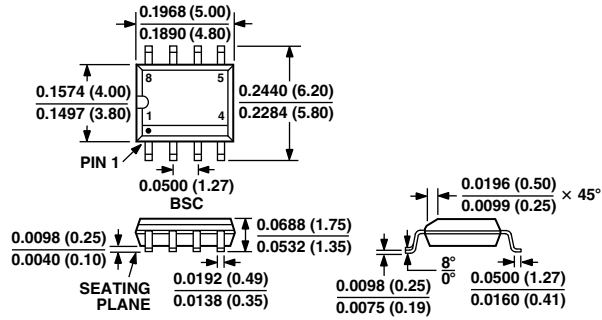

8-Lead Plastic DIP (N-8)

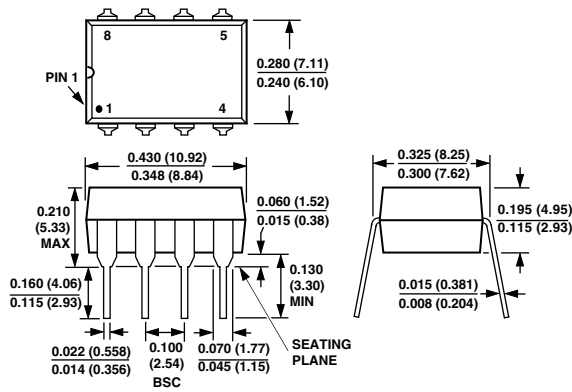

8-Lead Cerdip (Q-8)

