

# SCI7661C<sub>0A</sub>/M<sub>0A</sub>

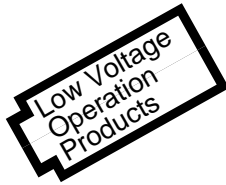

## DC-DC Converter

- 95% Typical Power Efficiency
- Doubled or Tripled Output Voltage
- Internal Voltage Regulator

### DESCRIPTION

The SCI7661C<sub>0A</sub>/M<sub>0A</sub> CMOS DC-DC Converter features high operational performance with low power dissipation. It consists of two major parts: the booster circuitry and the regulator circuitry. The booster generates a doubled output voltage (–2.4 to –12V) or tripled output voltage (–3.6 to –18V) from the input (–1.2 to –6V). The regulator is capable of setting the output to any desired voltage. The regulated voltage can be given one of the three threshold temperature gradients.

### FEATURES

- High performance with low power dissipation
- Simple conversion of  $V_{IN}$  (–5V) to  $|V_{IN}|$  (+5V),  $2|V_{IN}|$  (+10V),  $2V_{IN}$  (–10V) or  $3V_{IN}$  (–15V)
- On-chip output voltage regulator
- Power conversion efficiency–Typ. 95%
- Temperature gradient for LCD power supply – 0.1% / °C, 0.4%/°C or 0.6% / °C
- Power off by external signals – Stationary current at power off – Max. 2  $\mu$ A
- Cascade connection–two device connected:

$V_{IN}$  = –5V,  $V_{OUT}$  = –20V

- On-chip C'–R oscillator
- Package ..... SCI7661C<sub>0A</sub>: DIP-14pin(plastic)  
SCI7661M<sub>0A</sub>: SOP5-14pin(plastic)  
SCI7661M<sub>AA</sub>: SSOP2-16pin(plastic)

### BLOCK DIAGRAM

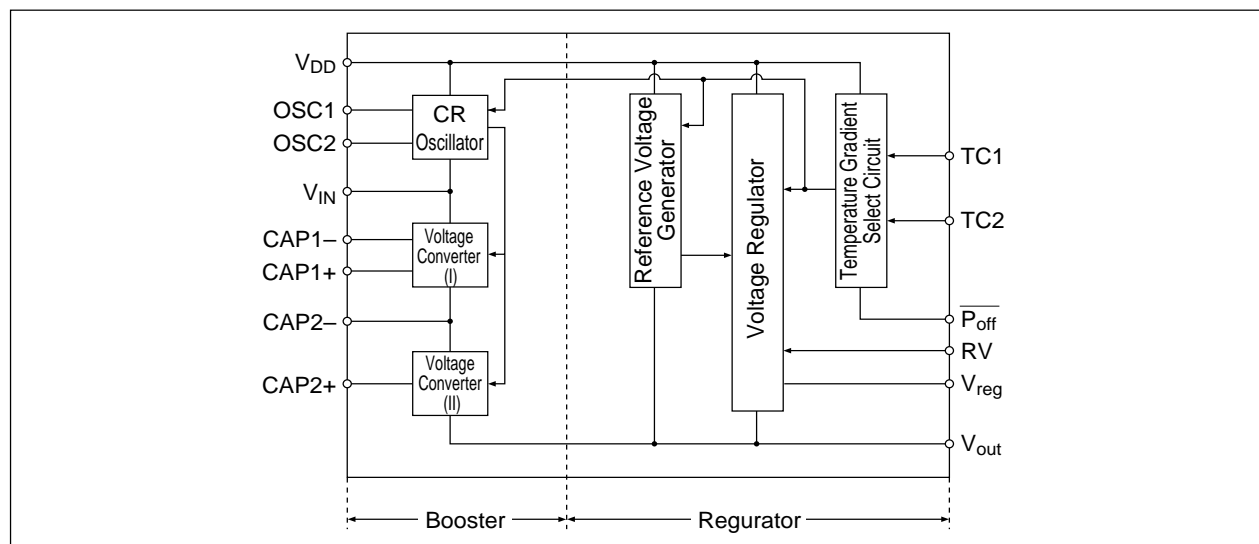

■ PIN CONFIGURATION

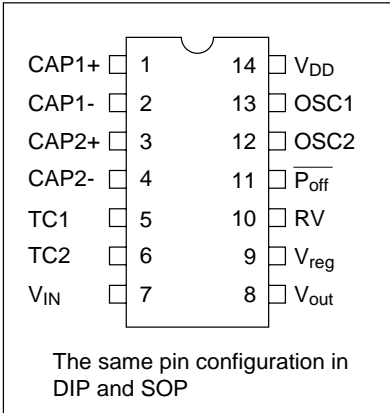

■ PIN DESCRIPTION

Pin name	No.	Function
CAP1+, CAP1-	1, 2	Terminal for connection of capacitor for doubler
CAP2+, CAP2-	3, 4	Terminal for connection of capacitor for tripler
TC1, TC2	5, 6	Temperature gradient selection terminal
V <sub>IN</sub>	7	Power supply terminal(negative, system supply GND)
V <sub>OUT</sub>	8	Output terminal at tripling
V <sub>reg</sub>	9	Regulated voltage output terminal
R <sub>V</sub>	10	Regulated voltage control terminal
P <sub>off</sub>	11	V <sub>reg</sub> output ON/OFF control terminal
OSC2, OSC1	12, 13	Oscillation resistor connection terminal
V <sub>DD</sub>	14	Power supply terminal(positive system supply VCC)

■ ABSOLUTE MAXIMUM RATINGS

(V<sub>DD</sub>=0V)

Rating	Symbol	Min.	Max.	Unit	Remark
Input supply voltage	V <sub>I</sub>	-20/N	0.5	V	N=2 : Doubler N=3 : Tripler
Input terminal voltage	V <sub>I</sub>	V <sub>IN</sub> -0.5	0.5	V	OSC1, P <sub>off</sub>
		V <sub>OUT</sub> -0.5	0.5	V	TC1, TC2, RV
Output voltage	V <sub>O</sub>	-20.0		V	
Allowable loss	P <sub>d</sub>		300	mW	
Operating temperature	T <sub>opr</sub>	-30	85	°C	Plastic package
Storage temperature	T <sub>stg</sub>	-55	150	°C	
Soldering temperature and time	T <sub>sol</sub>	260°C, 10s(at lead)		-	

Note: When this IC is soldered in the solder-reflow process, be sure to maintain the reflow furnace at the curve shown in "Fig. 1-5 Reflow Furnace Temperature Curve" of this DATA BOOK. And this IC can not be exposed to high temperature of the solder dipping.

■ ELECTRICAL CHARACTERISTICS

(V<sub>DD</sub> = 0V, V<sub>IN</sub>=-5V, T<sub>a</sub>=-30 to 85°C)

Characteristic	Symbol	Min.	Typ.	Max.	Unit	Condition
Input supply voltage	V <sub>I</sub>	-6.0		-1.2	V	
Output voltage	V <sub>O</sub>	-18.0			V	
	V <sub>reg</sub>	-18		-2.6	V	R <sub>L</sub> =∞, R <sub>RV</sub> =1MΩ, V <sub>O</sub> =-18V
Regulator operating voltage	V <sub>OUT</sub>	-18.0		-3.2	V	
Booster current consumption	I <sub>opr1</sub>		60	100	μA	R <sub>L</sub> =∞, R <sub>OSC</sub> =1MΩ
Regulator current consumption	I <sub>opr2</sub>		50	12.0	μA	R <sub>L</sub> =∞, R <sub>RV</sub> =1MΩ V <sub>OUT</sub> =-15V
Stationary current	I <sub>Q</sub>			2.0	μA	TC2=TC1=V <sub>OUT</sub> , R <sub>L</sub> =∞
Oscillation frequency	f <sub>osc</sub>	16	20	24	kHz	R <sub>OSC</sub> =1MΩ
Output impedance	R <sub>OUT</sub>		150	200	Ω	I <sub>OUT</sub> =10mA
Booster power conversion efficiency	P <sub>eff</sub>	90	95		%	I <sub>OUT</sub> =5mA
Regulated output voltage fluctuation	$\frac{\Delta V_{reg}}{\Delta V_{OUT} \cdot V_{reg}}$		0.2		%/V	-18V < V <sub>OUT</sub> < -8V, V <sub>reg</sub> =-8V, R <sub>L</sub> =∞, T <sub>a</sub> =25°C

Characteristic	Symbol	Min.	Typ.	Max.	Unit	Condition
Regulated output load fluctuation	$\frac{\Delta V_{reg}}{\Delta I_{OUT}}$		5		$\Omega$	$V_{OUT}=-15V, V_{reg}=-8V, T_a=25^\circ C$ $0 < I_{OUT} < 10mA, TC1=V_{DD}$ $TC2=V_{OUT}$
Regulated output saturation resistance	$R_{SAT}$		5		$\Omega$	$R_{SAT}=D(V_{reg}-V_{OUT})/D I_{OUT}$ $0 < I_{OUT} < 10mA, RV=V_{DD}, T_a=25^\circ C$
Reference voltage	$V_{RV0}$ $V_{RV1}$ $V_{RV2}$	-2.3 -1.7 -1.1	-1.5 -1.3 -0.9	-1.0 -1.1 -0.8	V V V	$TC2=V_{OUT}, TC1=V_{DD}, T_a=25^\circ C$ $TC2=TC1=V_{OUT}, T_a=25^\circ C$ $TC2=V_{DD}, TC1=V_{OUT}, T_a=25^\circ C$
Temperature Gradient	$CT^0$ $CT^4$ $CT^2$	-0.25 -0.5 -0.7	-0.1 -0.4 -0.6	-0.06 -0.3 -0.5	%/°C %/°C %/°C	$CT = \frac{ V_{reg}(50^\circ C)  -  V_{reg}(0^\circ C) }{50^\circ C - 0^\circ C}$ $\times \frac{1}{ V_{reg}(25^\circ C) } \times 100$
Input leakage current	$I_L$			2.0	$\mu A$	$P_{off}, TC1, TC2, OSC1, RV$ pins

RECOMMENDED OPERATING CONDITIONS

( $T_a = -30$  to  $85^\circ C$ )

Condition	Symbol	Min.	Max.	Unit	Remark
Booster start voltage	$V_{STA1}$		-1.2	V	$R_{OSC}=1M\Omega, C_3 \geq 10\mu F^*1$ $C_L/C_3 \leq 1/20, T_a = -20$ to $85^\circ C$
	$V_{STA2}$		-2.2	V	$R_{OSC}=1M\Omega$
Booster stop voltage	$V_{STP}$	-1.2		V	$R_{OSC}=1M\Omega$
Output load resistance	$R_L$	$R_L$ Min.*2		$\Omega$	
Output load current	$I_{OUT}$		20	mA	
Oscillation frequency	$f_{OSC}$	10	30	kHz	
External resistance for oscillation	$R_{OSC}$	680	2000	k $\Omega$	
Capasitor for booster	$C_1, C_2, C_3$	3.3		$\mu F$	
Regulated output adjustable resistance	$R_{RV}$	100	1000	k $\Omega$	

\*1: Recommended circuitry in low voltage operation is shown below.

\*2:  $R_L$  Min. depends on input voltage as shown below.

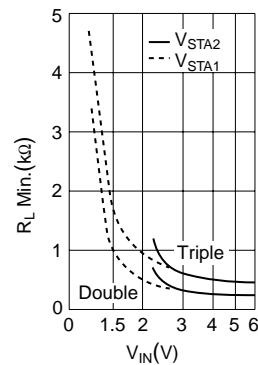
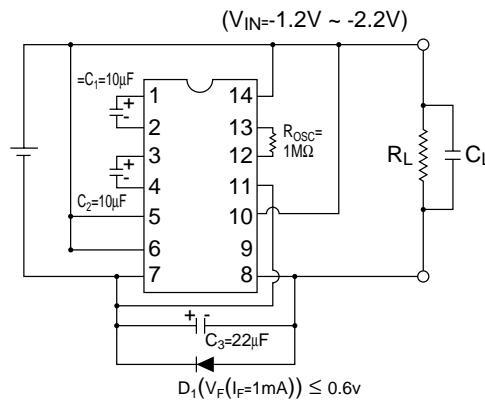

## PERFORMANCE CURVES

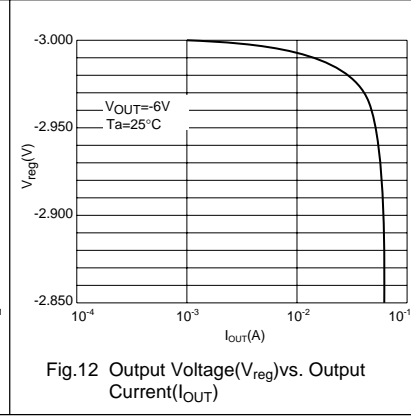
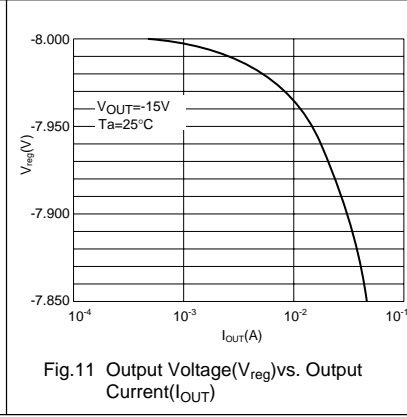
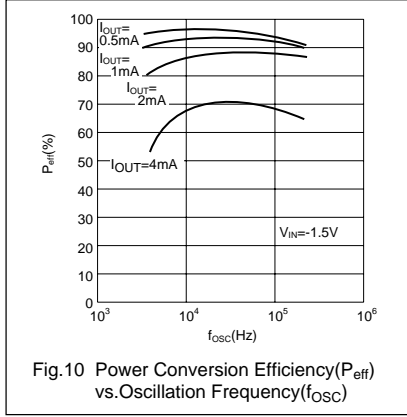
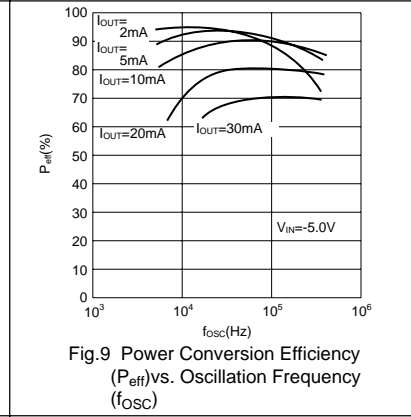
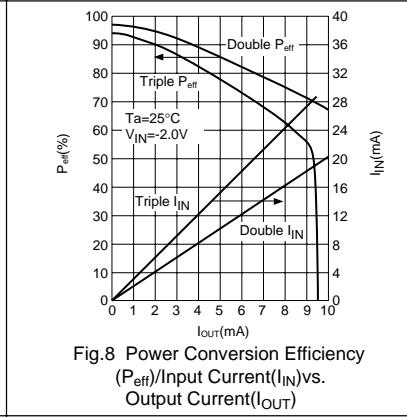
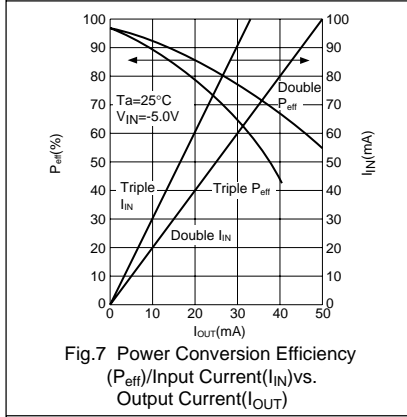
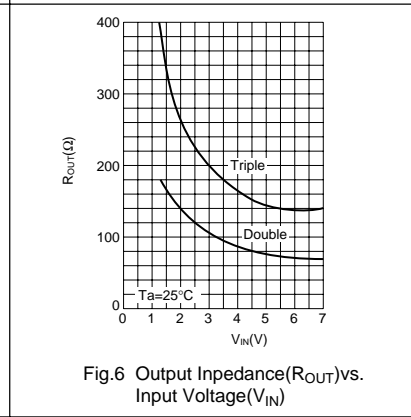
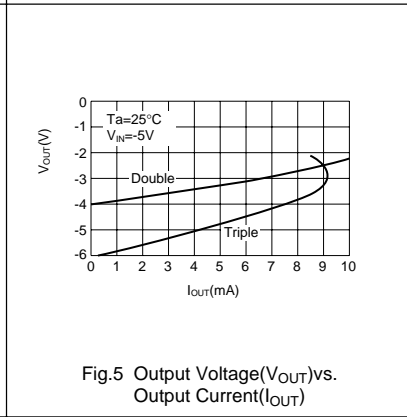
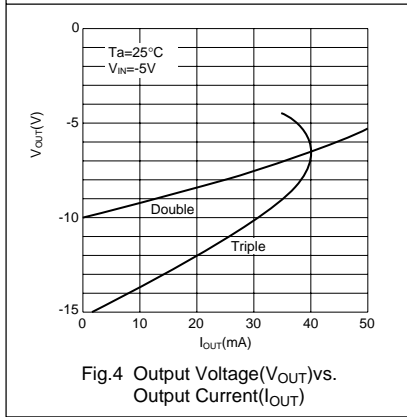
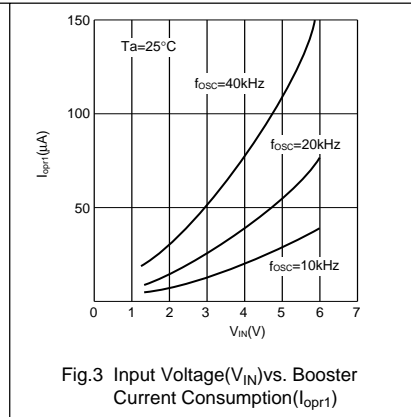
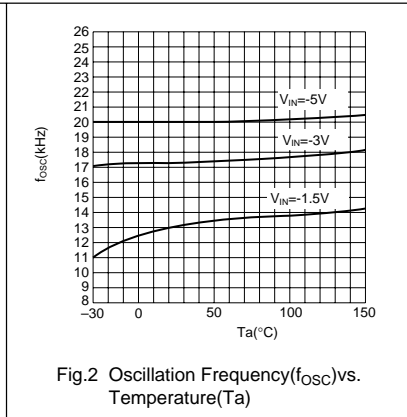
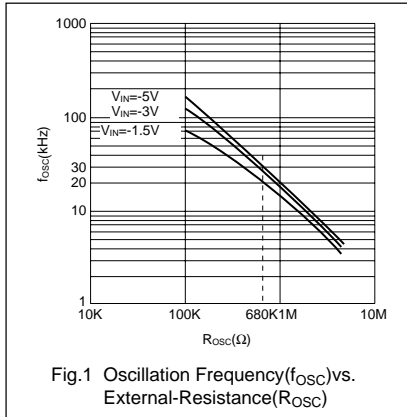

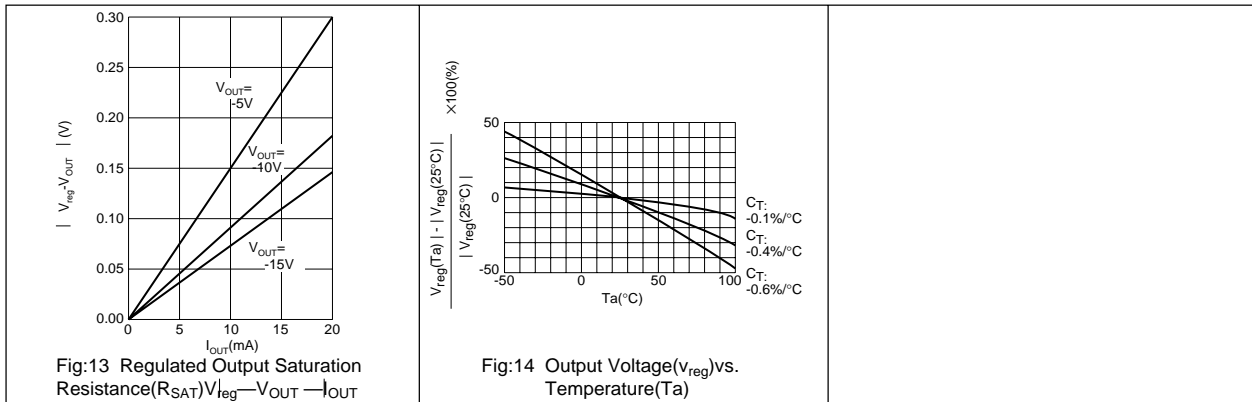

**CIRCUIT DESCRIPTION**

**C-R Oscillator**

The SCI7661C/M contains a C-R oscillator for internal oscillation. It consists of an external resistor  $R_{osc}$  connected between the OSC1 pin and OSC2 pin.

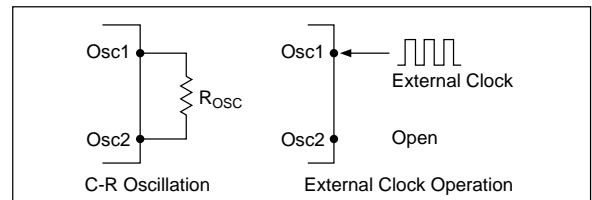

**Voltage Converters**

The voltage converters double/triple the input supply voltage ( $V_{IN}$ ) using clocks generated by the C-R oscillator

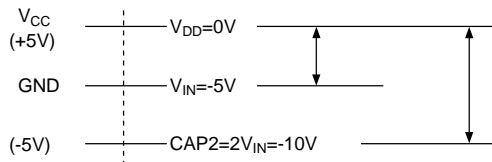

Typical Doubled Voltage Relations

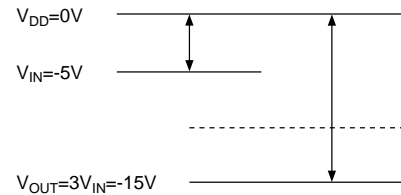

Typical Tripled Voltage Relations

**Reference Voltage Generator and Voltage Regulator**

The reference voltage generator produces reference voltage needed for operation of regulator circuit. The voltage regulator is used to regulate a boosted output voltage and its circuit contains a power-off function which uses signals from the system for on-off control of the  $V_{reg}$  output.

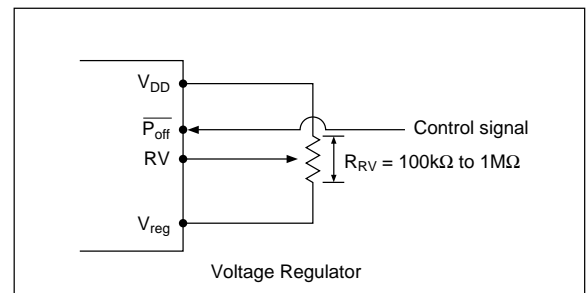

**Temperature Gradient Selector Circuit**

The SCI7661C/M provides the  $V_{reg}$  output with a temperature gradient suitable for LCD driving.

● Temperature Gradient Assignment

P <sub>off</sub>	TC2	TC1	Temp. Gradient	V <sub>reg</sub> Output	CR oscillation	Remarks
1(V <sub>DD</sub> )	L(V <sub>OUT</sub> )	L(V <sub>OUT</sub> )	-0.4%/°C	ON	ON	Cascade connection
1	L	H(V <sub>DD</sub> )	-0.1%/°C	ON	ON	
1	H(V <sub>DD</sub> )	L	-0.6%/°C	ON	ON	
1	H	H	-0.6%/°C	ON	OFF	
0(V <sub>IN</sub> )	L	L	-	OFF(Hi-Z)	OFF	
0	L	H	-	OFF(Hi-Z)	OFF	Without regulation
0	H	L	-	OFF(Hi-Z)	OFF	
0	H	H	-	OFF(Hi-Z)	ON	

NOTE: The potential at Low level is different between the P<sub>off</sub> pin and the TC1/TC2 pin.

■ BASIC EXTERNAL CONNECTION

● Voltage Doubler and Tripler

A doubled voltage can be obtained at V<sub>OUT</sub>(CAP2-) by disconnecting capacitor C<sub>2</sub> from the tripler configuration and shorting CAP2- (pin4) and V<sub>OUT</sub> (pin 8).

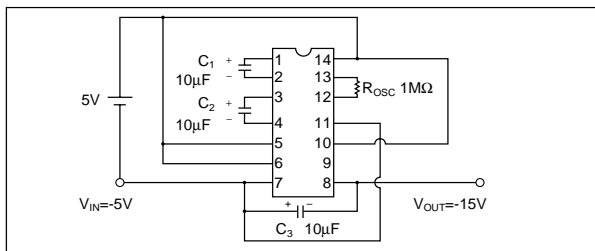

Voltage Tripler

● Voltage Tripler+Regulator

V<sub>reg</sub> output is given a temperature gradient, after boosted output V<sub>OUT</sub> regulated. In this connection, both V<sub>OUT</sub> and V<sub>reg</sub> can be taken out at the same time.

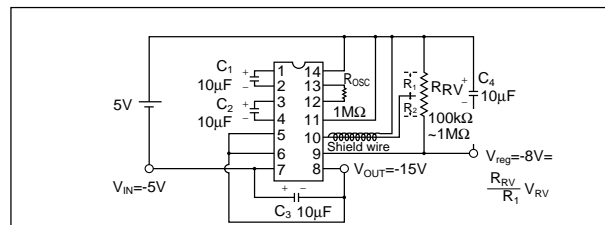

Tripler+Regulator  
(-0.4%/°C selected as temperature gradient)

● Parallel Connection

Parallel connection of n circuits can reduce R<sub>OUT</sub> to about 1/n, that output impedance R<sub>OUT</sub> can be reduced by connecting serial configuraiton. A single smoothing capacitor C<sub>3</sub> can be used commonly for all parallelly connected circuit.

In parallelly connection, a regulated output can be obtained by applying the regulation circuit to only one of the n parallelly connected circuit.

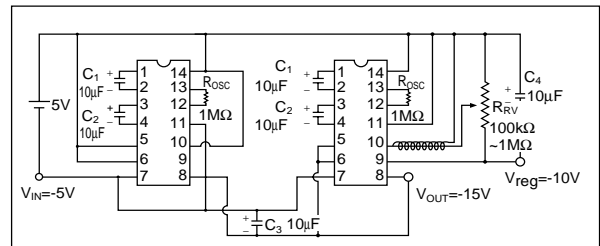

Parallel Connection

● Cascade Connection

Cascade connection of SCI7661C/M (by connecting V<sub>IN</sub> and V<sub>OUT</sub> of one stage to V<sub>DD</sub> and V<sub>IN</sub> respectively of the next stage) further increase the output voltage. Note, however, that the serial connection increases the output impedance.

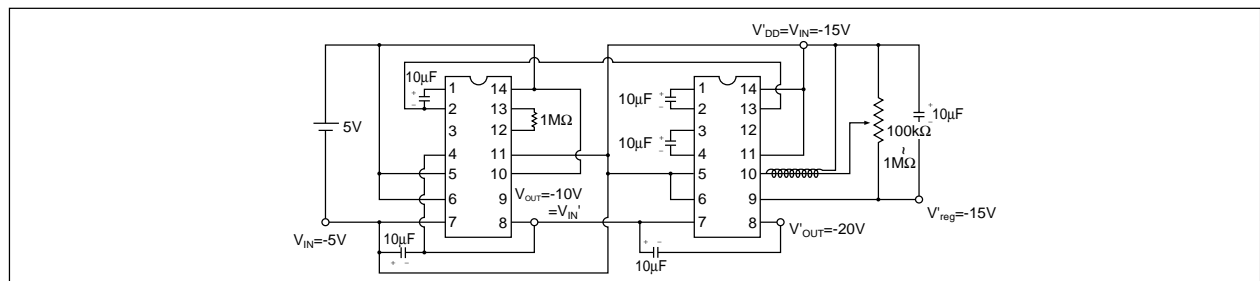

Serial Connection

● Positive Voltage Conversion

The input voltage can be doubled or tripled toward the positive side. (In the doubler configuration, capacitor  $C_2$  and diode  $D_3$  are disconnected and the diode  $D_3$  shorted at the both ends.) In this case, however, the output voltage decrease by  $V_F$ (forward voltage)

For example  $V_{DD}=0V$ ,  $V_{IN}=-5V$  and  $V_F=0.6V$ , then  $V_{OUT}=10V-3 \times 0.6V=8.2V$  (if doubled,  $5V-2 \times 0.6V=3.8V$ )

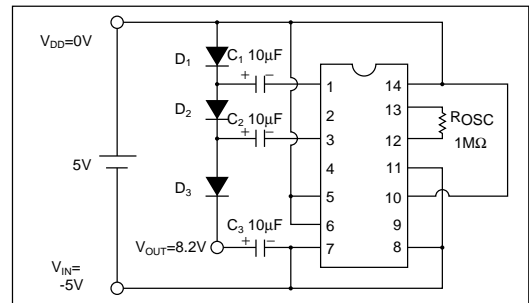

Positive Voltage Conversion  $D_1, D_2, D_3$ .: Shottky diodes with small  $V_F$  are recommended.

● Negative Voltage Conversion + Positive Voltage Conversion

This circuit produces outputs of  $-15V$  and  $+8.2V$  from the  $-5V$  input. Note that this configuration causes higher output impedance than in a single function (negative or positive voltage converter).

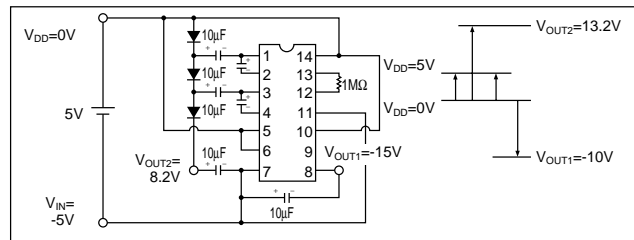

Negative Voltage Conversion +Positive Voltage Conversion

● Changing the Temperature Gradient through Use of External Temperature Sensor (Thermistor)

The SCI7661C/M has a temperature gradient selector circuit in its regulator. It selects any one of the three gradients:  $-0.1\% / ^\circ C$ ,  $-0.4\% / ^\circ C$  and  $-0.6\% / ^\circ C$ . It is necessary that the temperature gradient can be changed to any other value by connecting a thermistor in series to the output voltage control resistor  $R_{RV}$ .

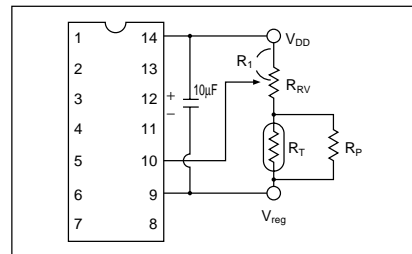

Example of Change of Temperature Gradient

■ PACKAGE DIMENSIONS

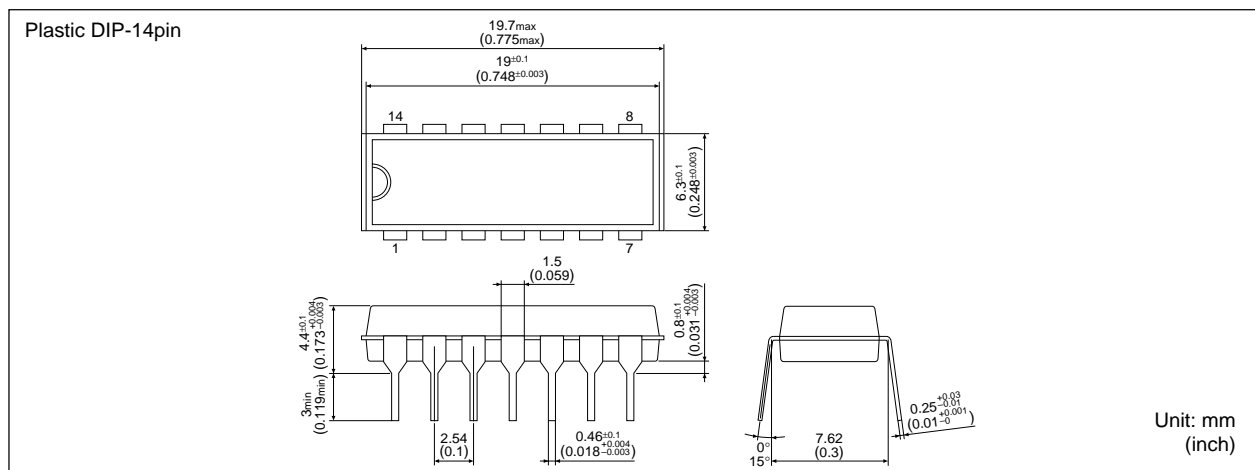

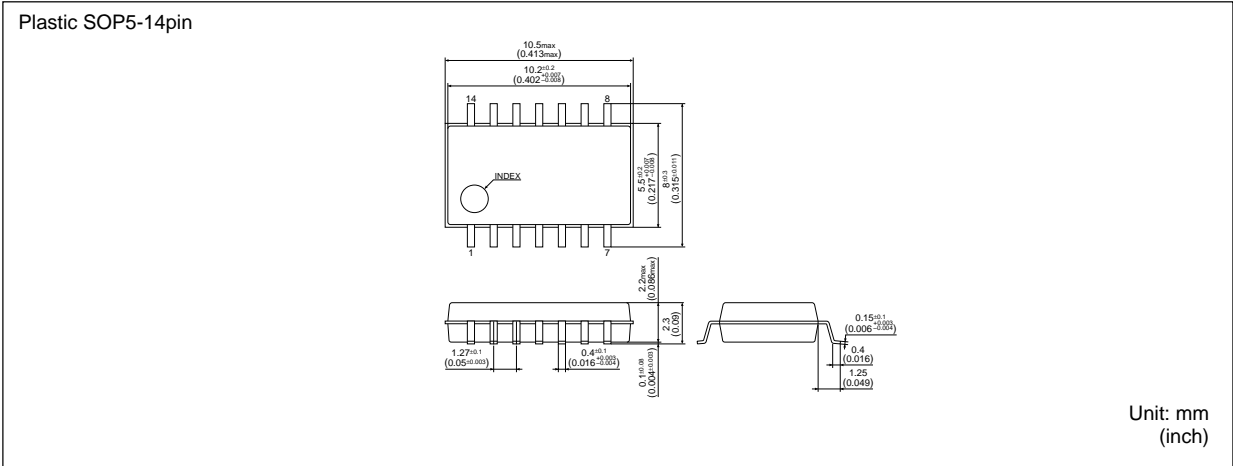



**NOTICE**

No part of this material may be reproduced or duplicated in any form or by any means without the written permission of Seiko Epson. Seiko Epson reserves the right to make changes to this material without notice. Seiko Epson does not assume any liability of any kind arising out of any inaccuracies contained in this material or due to its application or use in any product or circuit and, further, there is no representation that this material is applicable to products requiring high level reliability, such as, medical products. Moreover, no license to any intellectual property rights is granted by implication or otherwise, and there is no representation or warranty that anything made in accordance with this material will be free from any patent or copyright infringement of a third party. This material or portions thereof may contain technology or the subject relating to strategic products under the control of the Foreign Exchange and Foreign Trade Control Law of Japan and may require an export license from the Ministry of International Trade and Industry or other approval from another government agency.

All product names mentioned herein are trademarks and/or registered trademarks of their respective companies.

©Seiko Epson Corporation 1998 All rights reserved.

**SEIKO EPSON CORPORATION****ELECTRONIC DEVICES MARKETING DIVISION****Electronic Device Marketing Department  
IC Marketing & Engineering Group**

421-8, Hino, Hino-shi, Tokyo 191-8501, JAPAN  
Phone: +81-(0)42-587-5816 Fax: +81-(0)42-587-5624

**ED International Marketing Department I (Europe & U.S.A.)**

421-8, Hino, Hino-shi, Tokyo 191-8501, JAPAN  
Phone: +81-(0)42-587-5812 Fax: +81-(0)42-587-5564

**ED International Marketing Department II (Asia)**

421-8, Hino, Hino-shi, Tokyo 191-8501, JAPAN  
Phone: +81-(0)42-587-5814 Fax: +81-(0)42-587-5110

Electric Device Information of EPSON WWW server

<http://www.epson.co.jp>

