

DUAL STEPPER MOTOR DRIVER

■ GENERAL DESCRIPTION

The NJM3771 is a stepper motor driver, which circuit is especially developed for use in microstepping applications in conjunction with the matching dual DAC (Digital-to-Analog Converter) NJU39610.

The NJM3771 contains a clock oscillator, which is common for both driver channels; a set of comparators and flip-flops implementing the switching control; and two H-bridges with internal recirculation diodes. Voltage supply requirements are +5 V for logic and +10 to +45 V for the motor. Maximum output current is 650 mA per channel.

■ PACKAGE OUTLINE

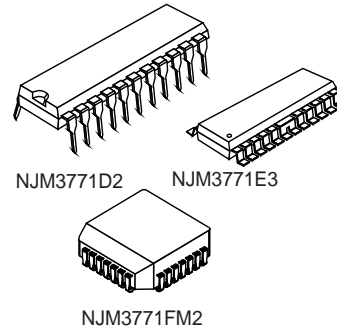

■ FEATURES

- Dual chopper driver
- 650 mA output current per channel
- Selectable slow/fast current decay for improved high-speed microstepping
- Specially matched to Dual DAC NJU39610
- Packages DIP22 / EMP24(Batwing) / PLCC28

■ BLOCK DIAGRAM

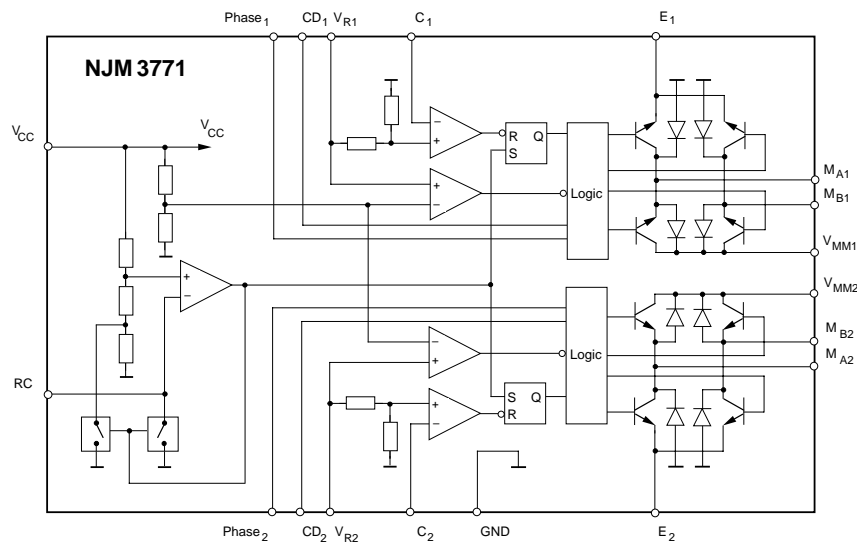

Figure 1. Block diagram

PIN CONFIGURATIONS

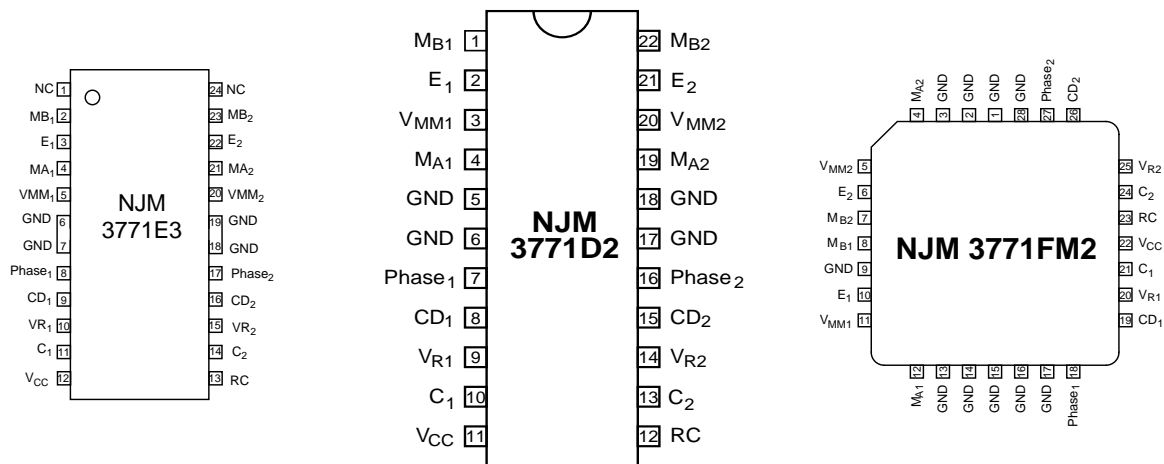

Figure 2. Pin configurations

PIN DESCRIPTION

Refer to Figure 2

| EMP | DIP | PLCC | Symbol | Description |
|---------------|---------------|--------------------|--------------------|--|
| 2 | 1 | 8 | M _{B1} | Motor output B, channel 1. Motor current flows from M _{A1} to M _{B1} when Phase ₁ is HIGH. |
| 3 | 2 | 10 | E ₁ | Common emitter, channel 1. This pin connects to a sensing resistor to ground. |
| 4 | 3 | 11 | V _{MM1} | Motor supply voltage, channel 1, 10 to 40 V. V _{MM1} and V _{MM2} should be connected together. |
| 5 | 4 | 12 | M _{A1} | Motor output A, channel 1. Motor current flows from M _{A1} to M _{B1} when Phase ₁ is HIGH. |
| 6,7, 18,19 | 5,6, 17,18 | 1-3,9, 13-17,28 | GND | Ground and negative supply. Note: these pins are used thermally for heat-sinking. Make sure that all ground pins are soldered onto a suitably large copper ground plane for efficient heat sinking. |
| 8 | 7 | 18 | Phase ₁ | Controls the direction of motor current at outputs M _{A1} and M _{B1} . Motor current flows from M _{A1} to M _{B1} when Phase ₁ is HIGH. |
| 9 | 8 | 19 | CD ₁ | Current decay control, channel 1. A logic HIGH on this input results in <i>slow</i> current decay, a LOW results in <i>fast</i> current decay, see "Functional Description." |
| 10 | 9 | 20 | V _{R1} | Reference voltage, channel 1. Controls the threshold voltage for the comparator and hence the output current. Input resistance is typically 2.5 kohms, ±20%. |
| 11 | 10 | 21 | C ₁ | Comparator input channel 1. This input senses the instantaneous voltage across the sensing resistor, filtered by an RC network. The threshold voltage for the comparator is $(0.450 / 2.5) \cdot V_{R1}$, i.e. 450 mV at V _{R1} = 2.5 V. |
| 12 | 11 | 22 | V _{CC} | Logic voltage supply, nominally +5 V. |
| 13 | 12 | 23 | RC | Clock oscillator RC pin. Connect a 15 kohm resistor to V _{CC} and a 3300 pF capacitor to ground to obtain the nominal switching frequency of 26.5 kHz. |
| 14 | 13 | 24 | C ₂ | Comparator input channel 2. This input senses the instantaneous voltage across the sensing resistor, filtered by an RC network. The threshold voltage for the comparator is $(0.450 / 2.5) \cdot V_{R1}$, i.e. 450 mV at V _{R1} = 2.5 V. |
| 15 | 14 | 25 | V _{R2} | Reference voltage, channel 2. Controls the threshold voltage for the comparator and hence the output current. Input resistance is typically 2.5 kohms, ±20%. |
| 16 | 15 | 26 | CD ₂ | Current decay control, channel 2. A logic HIGH on this input results in <i>slow</i> current decay, a LOW results in <i>fast</i> current decay, see "Functional Description." |
| 17 | 16 | 27 | Phase ₂ | Controls the direction of motor current at outputs M _{A2} and M _{B2} . Motor current flows from M _{A2} to M _{B2} when Phase ₂ is HIGH. |
| 20 | 19 | 4 | M _{A2} | Motor output A, channel 2. Motor current flows from M _{A2} to M _{B2} when Phase ₂ is HIGH. |
| 21 | 20 | 5 | V _{MM2} | Motor supply voltage, channel 2, 10 to 40 V. V _{MM1} and V _{MM2} should be connected together. |
| 22 | 21 | 6 | E ₂ | Common emitter, channel 2. This pin connects to a sensing resistor to ground. |
| 23 | 22 | 7 | M _{B2} | Motor output B, channel 2. Motor current flows from M _{A2} to M _{B2} when Phase ₂ is HIGH. |

■ FUNCTIONAL DESCRIPTION

Each channel of the NJM3771 consists of the following sections: an H-bridge output stage, capable of driving up to 650 mA continuous motor current (or 500 mA, both channels driven), a logic section that controls the output transistors, an S-R flip-flop, and two comparators. The oscillator is common to both channels.

Constant current control is achieved by switching the current to the windings. This is done by sensing the (peak) voltage across a current-sensing resistor, R_s , effectively connected in series with the motor winding, and feeding that voltage back to a comparator. When the motor current reaches a threshold level, determined by the voltage at the reference input, V_R , the comparator resets the flip-flop, which turns off the output transistors. The current decreases until the clock oscillator triggers the flip-flop, which turns on the output transistors again, and the cycle is repeated.

The current-decay rate during the turn-off portion of the switching cycle, can be selected fast or slow by the CD input.

In slow current-decay mode, only one of the lower transistors in the H-bridge (those closest to the negative supply) is switched on and off, while one of the upper transistors is held constantly on. During turn-off, the current recirculates through the upper transistor (which one depends on current direction) and the corresponding free-wheeling diode connected to V_{MM} , see figure 3.

In fast current decay mode, both the upper and lower transistors are switched. During the off-time, the freewheeling current is opposed by the supply voltage, causing a rapid discharge of energy in the winding.

Fast current decay may be required in half- and microstepping applications when rapid changes of motor current are necessary. Slow current decay, however, gives less current ripple, and should always be selected, if possible, to minimize core losses and switching noise.

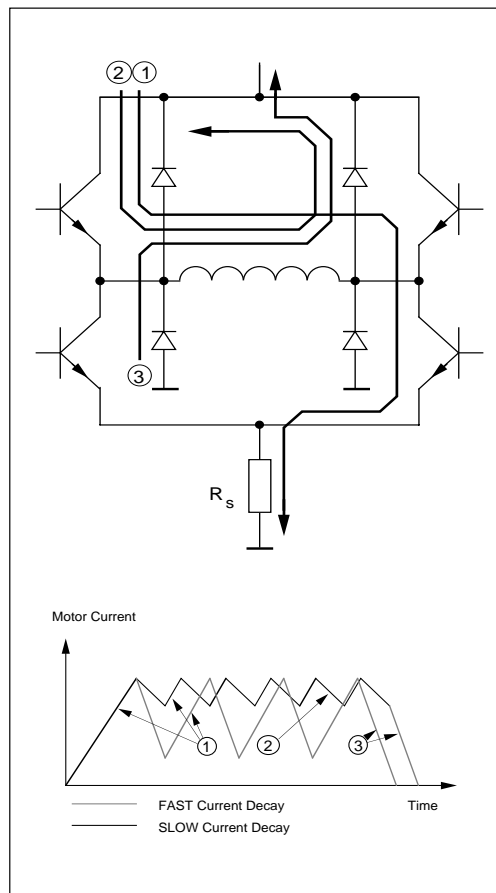

Figure 3. Output stage with current paths during turn-on, turn-off and phase shift

■ ELECTRICAL CHARACTERISTICS

 Electrical characteristics over recommended operating conditions, unless otherwise noted. $-20^{\circ}\text{C} \leq T_J \leq +125^{\circ}\text{C}$

| Parameter | Symbol | Conditions | Min | Typ | Max | Unit |
|-------------------------------------|---------------|---|------|------|------|---------------|
| General | | | | | | |
| Supply current | I_{CC} | | - | 38 | 50 | mA |
| Total power dissipation | P_D | $V_{MM} = 40\text{ V}$, $I_{M1} = 450\text{ mA}$, $I_{M2} = 0\text{ mA}$. Notes 2, 3. | | 1.4 | 1.6 | W |
| | | $V_{MM} = 40\text{ V}$, $I_{M1} = I_{M2} = 318\text{ mA}$. Notes 2, 3. | | 1.6 | 1.8 | W |
| Turn-off delay | t_d | $T_a = +25^{\circ}\text{C}$, $dV_C/dt \geq 50\text{ mV}/\mu\text{s}$. Note 3. | - | 1.0 | 1.5 | μs |
| Logic Inputs | | | | | | |
| Logic HIGH input voltage | V_{IH} | | 2.0 | - | - | V |
| Logic LOW input voltage | V_{IL} | | - | - | 0.6 | V |
| Logic HIGH input current | I_{IH} | $V_I = 2.4\text{ V}$ | - | - | 20 | μA |
| Logic LOW input current | I_{IL} | $V_I = 0.4\text{ V}$ | -0.4 | - | - | mA |
| Reference Inputs | | | | | | |
| Input resistance | R_R | $T_a = +25^{\circ}\text{C}$ | - | 5 | - | kohm |
| Input current | I_R | $T_a = +25^{\circ}\text{C}$, $V_R = 2.5\text{ V}$. | | 0.5 | 1.0 | mA |
| Turn-off voltage | V_{TO} | | 20 | 29 | 38 | mV |
| Comparator Inputs | | | | | | |
| Threshold voltage | V_{CH} | $R_C = 1\text{ kohms}$, $V_R = 2.5\text{ V}$ | 430 | 450 | 470 | mV |
| $ V_{CH1} - V_{CH2} $ mismatch | $V_{CH,diff}$ | $R_C = 1\text{ kohms}$ | - | 1 | - | mV |
| Input current | I_C | | -10 | - | 1 | μA |
| Motor Outputs | | | | | | |
| Lower transistor saturation voltage | | $I_M = 500\text{ mA}$ | - | 1.00 | 1.20 | V |
| Lower transistor leakage current | | $V_{MM} = 41\text{ V}$, $V_E = V_R = 0\text{ V}$, $V_C = V_{CC}$ | - | - | 300 | μA |
| Lower diode forward voltage drop | | $I_M = 500\text{ mA}$ | - | 1.10 | 1.25 | V |
| Upper transistor saturation voltage | | $I_M = 500\text{ mA}$ | - | 1.20 | 1.35 | V |
| Upper transistor leakage current | | $V_{MM} = 41\text{ V}$, $V_E = V_R = 0\text{ V}$, $V_C = V_{CC}$ | - | - | 300 | μA |
| Upper diode forward voltage drop | | $I_M = 500\text{ mA}$ | - | 1.00 | 1.25 | V |
| Chopper Oscillator | | | | | | |
| Chopping frequency | f_s | $C_T = 3300\text{ pF}$, $R_T = 15\text{ kohms}$ | 25.0 | 26.5 | 28.0 | kHz |

■ THERMAL CHARACTERISTICS

| Parameter | Symbol | Conditions | Min | Typ | Max | Unit |
|--------------------|------------------|-----------------------|-----|-----|-----|-----------------------------|
| Thermal resistance | $R_{th_{J-GND}}$ | DIP package. | - | 11 | - | $^{\circ}\text{C}/\text{W}$ |
| | $R_{th_{J-A}}$ | DIP package. Note 2. | - | 40 | - | $^{\circ}\text{C}/\text{W}$ |
| | $R_{th_{J-GND}}$ | PLCC package. | - | 9 | - | $^{\circ}\text{C}/\text{W}$ |
| | $R_{th_{J-A}}$ | PLCC package. Note 2. | - | 35 | - | $^{\circ}\text{C}/\text{W}$ |
| | $R_{th_{J-GND}}$ | EMP package. | - | 13 | - | $^{\circ}\text{C}/\text{W}$ |
| | $R_{th_{J-A}}$ | EMP package. Note 2. | - | 42 | - | $^{\circ}\text{C}/\text{W}$ |

Notes

1. All voltages are with respect to ground. Currents are positive into, negative out of specified terminal.
2. All ground pins soldered onto a 20 cm^2 PCB copper area with free air convection.
3. Not covered by final test program.
4. Switching duty cycle $D = 30\%$, $f_s = 26.5\text{ kHz}$

External components

The voltage across the sensing resistor is fed back to the comparator via a low-pass filter section, to prevent erroneous switching due to switching transients. The recommended filter component values, 1 kohm and 820 pF, are suitable for a wide range of motors and operational conditions.

Since the low-pass filtering action introduces a small delay of the signal to the comparator, peak voltage across the sensing resistor, and hence the peak motor current, will reach a slightly higher level than the threshold, V_C , set by the reference voltage

$$(V_C = 450 \text{ mV @ } V_R = 2.5 \text{ V}).$$

The time constant of the low-pass filter may therefore be reduced to minimize the delay and optimize low-current performance, especially if a low (12 V) supply voltage is used. Increasing the time constant may result in unstable switching.

The frequency of the clock oscillator is set by the R-C combination at pin RC. The recommended values give a nominal frequency of 26.5 kHz. A lower frequency will result in higher current ripple and may cause audible noise from the motor, while increasing the frequency results in higher switching losses and possibly increased iron losses in the motor.

The sensing resistor, R_S , should be selected for maximum motor current. The relationship between peak motor current, reference voltage and the value of R_S is described under "Current control" above. Be sure not to exceed the maximum output current which is 650 mA per channel (or 500 mA per channel, both channels fully on, see "Recommended Operating Conditions").

Motor selection

The NJM3771 is designed for bipolar motors, i.e., motors that have only one winding per phase. A unipolar motor, having windings with a center tap, can also be used, see figure 8.

The chopping principle in the NJM3771 is based on a constant frequency and a varying duty cycle. This scheme imposes certain restrictions on motor selection. Unstable chopping can occur if the chopping duty cycle exceeds approximately 50%. To avoid this, it is necessary to choose a motor with a low winding resistance. Low winding resistance means less inductance and will therefore enable higher stepping rates, however it also means less torque capability. A compromise has to be made.

Choose a motor with the lowest possible winding resistance that still gives the required torque and use as high supply voltage as possible without exceeding the maximum recommended 40 V. Check that the chopping duty cycle does not exceed 50% at maximum current.

Since the NJM3771 produces a regulated, constant output current it is not necessary to use a motor that is rated at the same voltage as the actual supply voltage. Only rated current needs to be considered. Typical motors to be used together with the NJM3771 have voltage ratings of 5 to 12 V, while the supply voltage usually ranges from 24 to 40 V.

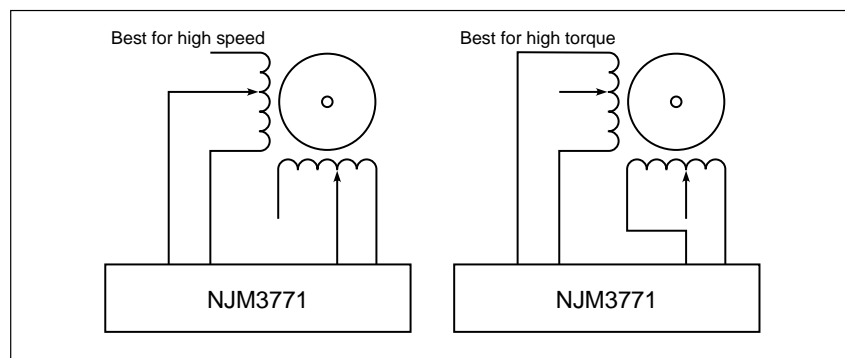

Figure 8. Connection of unipolar motors

General

Phase inputs

A logic HIGH on a Phase input gives positive current flowing out from M_A into M_B . A logic LOW gives a current in the opposite direction.

Slow/fast current decay

A logic HIGH on the CD input gives slow current decay, a logic LOW gives fast current decay.

Heat sinking

Soldering the four center pins onto a free PCB copper area of 20 cm² (approx. 1.8" x 1.8", copper foil thickness = 35 μm) permits the circuit to operate with a maximum of 320 mA output current, both channels driving, at ambient temperatures up to +70°C. Consult figures 9 and 14 in order to determine the necessary copper area for heat sinking if higher currents are required.

Thermal shutdown

The circuit is equipped with a thermal shutdown function that reduces the output current at chip temperatures above +160°C.

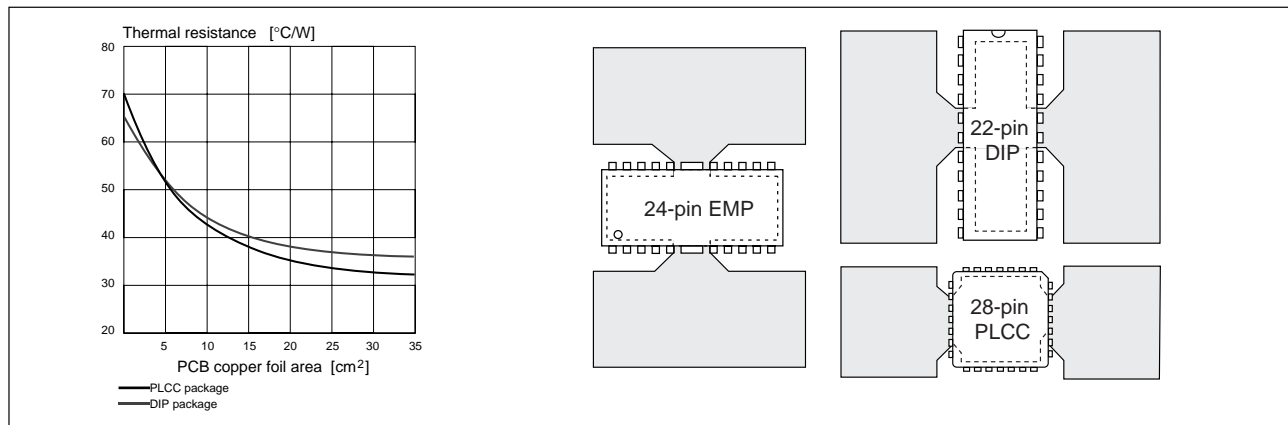

Figure 9. Thermal Resistance vs. PC Board copper area and suggested layout

■ TYPICAL CHARACTERISTICS

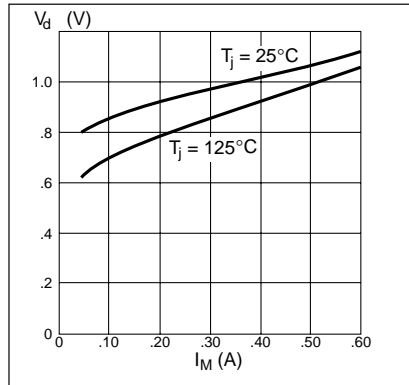

Figure 10. Typical upper diode voltage drop vs. recirculating current

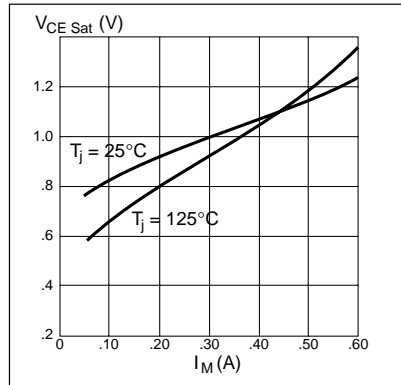

Figure 11. Typical source saturation voltage vs. output current

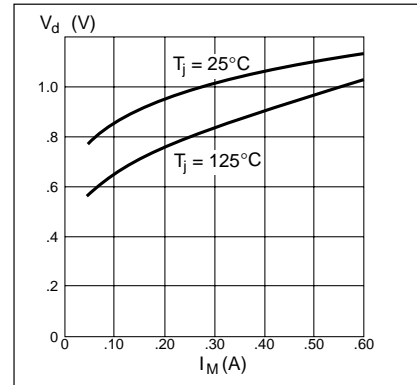

Figure 12. Typical lower diode voltage drop vs. recirculating current

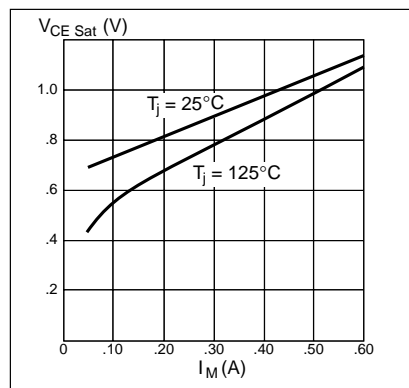

Figure 13 Typical sink saturation voltage vs. output current

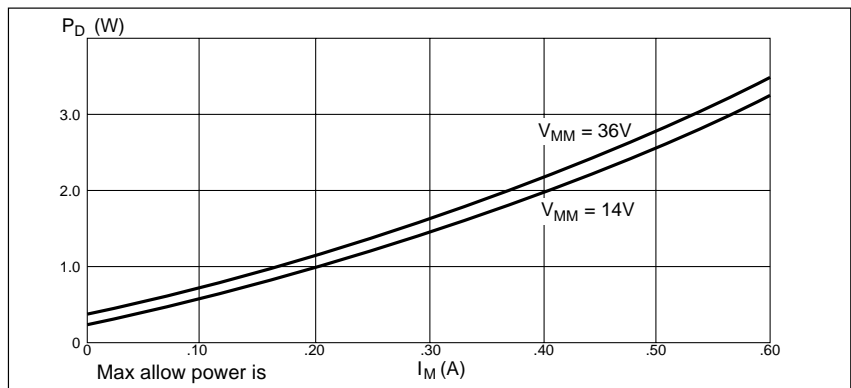

Figure 14. Power dissipation vs. motor current, both channels driven, $T_a = 25^\circ\text{C}$

The specifications on this databook are only given for information, without any guarantee as regards either mistakes or omissions. The application circuits in this databook are described only to show representative usages of the product and not intended for the guarantee or permission of any right including the industrial rights.