



**SINGLE/DUAL PRECISION HIGH SPEED MICROPOWER TIMER**

**GENERAL DESCRIPTION**

The ALD1502/ALD2502 timers are high performance single/dual monolithic timing circuits built with advanced silicon gate CMOS technology. They offer the benefits of high input impedance, thereby allowing smaller timing capacitors and a longer timing cycle; high speed, with typical cycle time of 400ns; low power dissipation for battery operated environment; reduced supply current spikes, allowing smaller and lower cost decoupling capacitors.

Each timer is capable of producing accurate time delays and oscillations in both monostable and astable operation, and operates in the one-shot (monostable) mode or 50% duty cycle free running oscillation mode with a single resistor and one capacitor. The inputs and outputs are fully compatible with CMOS, NMOS or TTL logic.

There are three matched internal resistors (approximately 200KΩ each) that set the threshold and trigger levels at two-thirds and one-third respectively of V+. These levels can be adjusted by using the control terminal. When the trigger input is below the trigger level, the output is in the high state and sourcing 2mA. When the threshold input is above the threshold level at the same time the trigger input is above the trigger level, the internal flip-flop is reset, the output goes to the low state and sinks up to 10mA. The reset input overrides all other inputs and when it is active (reset voltage less than 1V), the output is in the low state.

**FEATURES**

- High speed operation -- 2.5MHz typical oscillation at 5V
- High discharge sinking current of 80mA at 5V
- Guaranteed low operating supply voltage of 2V to 12V
- Functional equivalent to and same pin-out as NE555/NE556 with greatly expanded high and low frequency ranges
- High speed, low power, monolithic CMOS technology
- Low supply current 50µA typical for ALD1502 and 100µA typical for ALD2502
- Extremely low trigger, threshold and reset currents 10pA typical
- Operates in both monostable and astable modes
- Fixed 50% duty cycle or adjustable duty cycle
- CMOS, NMOS and TTL compatible input/output
- Low supply current spikes

**ORDERING INFORMATION**

Operating Temperature Range *		
-55°C to +125°C	0°C to +70°C	0°C to +70°C
8-Pin CERDIP Package ALD1502 DA	8-Pin Small Outline Package (SOIC) ALD1502 SA	8-Pin Plastic Dip Package ALD1502PA
14-Pin CERDIP Package ALD2502 DB	14-Pin Small Outline Package (SOIC) ALD2502 SB	14-Pin Plastic Dip Package ALD2502 PB

\* Contact factory for industrial temperature range

**APPLICATIONS**

- High speed one-shot (monostable) pulse generation
- Precision timing
- Sequential timing
- Long delay timer
- Pulse width and pulse position modulation
- Missing pulse detector
- Frequency divider
- Synchronized timer

**PIN CONFIGURATION**

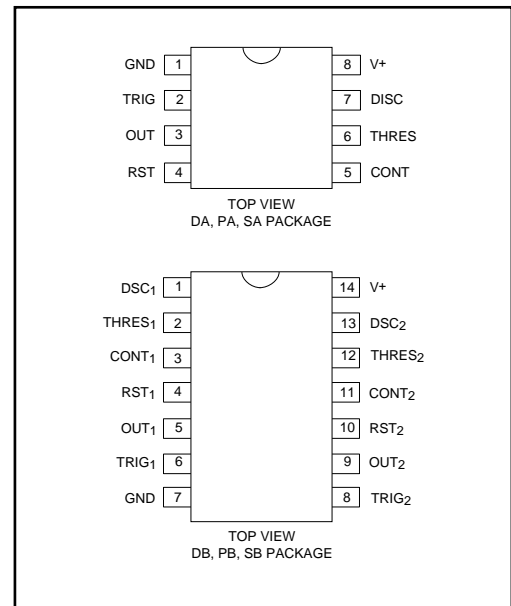

**BLOCK DIAGRAM (EACH TIMER)**

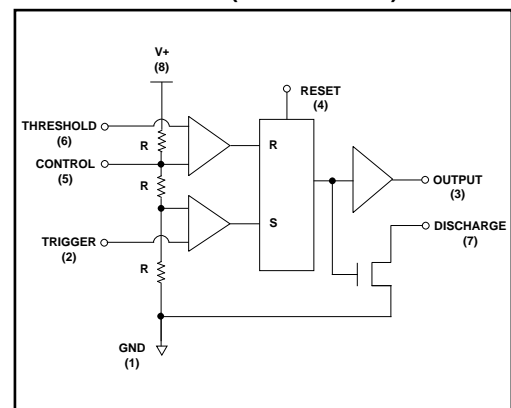

## ABSOLUTE MAXIMUM RATINGS

Supply voltage, V+ \_\_\_\_\_ 13.2V  
 Input voltage range \_\_\_\_\_ -0.3V to V+ +0.3V  
 Power dissipation \_\_\_\_\_ 600 mW  
 Operating temperature range PA, PB, SA, SB package \_\_\_\_\_ 0°C to + 70°C  
 DA, DB package \_\_\_\_\_ -55°C to +125°C  
 Storage temperature range \_\_\_\_\_ -65°C to +150°C  
 Lead temperature, 10 seconds \_\_\_\_\_ +260°C

## OPERATING ELECTRICAL CHARACTERISTICS

**T<sub>A</sub> = 25°C V+ = +5V unless otherwise specified**

Parameter	Symbol	Min	Typ	Max	Unit	Test Conditions
Supply Voltage	V+	2		12	V	
Supply Current ALD1502 Supply Current ALD2502	I <sub>S</sub> I <sub>S</sub>		50 100	90 180	μA μA	Outputs Unloaded
Timing error / Astable mode Initial Accuracy	t <sub>err</sub>		1.0	2.2	%	C = 0.1μF
Drift with Temperature <sup>1</sup> Drift with Supply Voltage <sup>1</sup>	Δt/ΔT Δt/ΔV+		10.0 0.2		ppm/°C %/V	R <sub>A</sub> = 1KΩ R <sub>B</sub> = 1KΩ
Threshold Voltage	V <sub>TH</sub>	3.233	3.333	3.433	V	
Trigger Voltage	V <sub>TRIG</sub>	1.567	1.667	1.767	V	
Trigger Current <sup>2</sup>	I <sub>TRIG</sub>		.01	0.4	nA	
Reset Voltage	V <sub>RST</sub>	0.4	0.7	1.0	V	
Reset Current <sup>2</sup>	I <sub>RST</sub>		.01	0.4	nA	
Threshold Current <sup>2</sup>	I <sub>TH</sub>		.01	0.4	nA	
Control Voltage Level	V <sub>CONT</sub>	3.233	3.333	3.433	V	
Output Voltage Drop (Low)	V <sub>OL</sub>		0.2	0.4	V	I <sub>SINK</sub> = 10mA
Output Voltage Drop (High)	V <sub>OH</sub>	4.2	4.6		V	I <sub>SOURCE</sub> = -2mA
Rise Time of Output <sup>1</sup>	t <sub>r</sub>		10	20	ns	R <sub>L</sub> = 10MΩ
Fall Time of Output <sup>1</sup>	t <sub>f</sub>		10	20	ns	C <sub>L</sub> = 10pF
Discharge Transistor Leakage Current	I <sub>DL</sub>		.01		nA	
Discharge Voltage Drop	V <sub>DISC</sub>		0.5 0.2	1.0 0.4	V V	I <sub>DISCHARGE</sub> = 80mA I <sub>DISCHARGE</sub> = 30mA
Maximum Frequency Astable Mode	f <sub>MAX</sub>	1.5	2.5		MHz	R <sub>A</sub> = 470Ω R <sub>B</sub> = 200Ω C <sub>T</sub> = 100pF
Minimum Trigger Pulse Width <sup>1</sup>	t <sub>TRIG</sub>		50	100	ns	

Notes: <sup>1</sup> Sample tested parameters.

<sup>2</sup> Consists of junction leakage currents with strong temperature dependence.

# TYPICAL PERFORMANCE CHARACTERISTICS

**DISCHARGE OUTPUT SINK CURRENT AS A FUNCTION OF DISCHARGE LOW VOLTAGE**

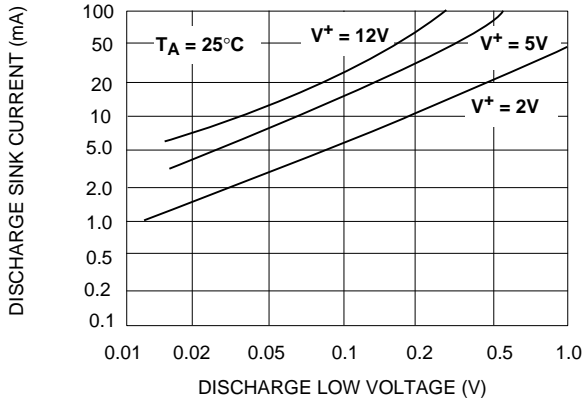

**MINIMUM PULSE WIDTH REQUIRED FOR TRIGGERING**

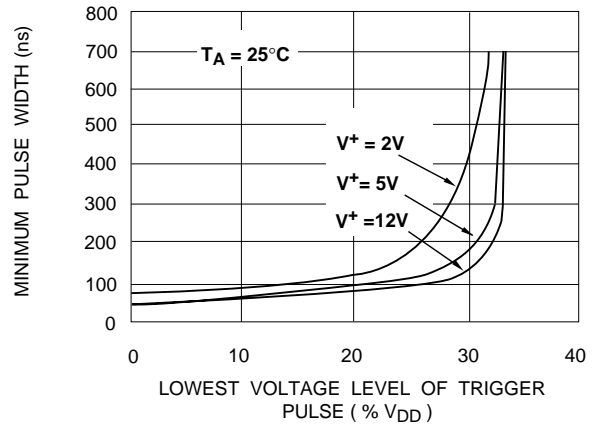

**FREE RUNNING FREQUENCY AS A FUNCTION OF  $R_A$ ,  $R_B$  AND C**

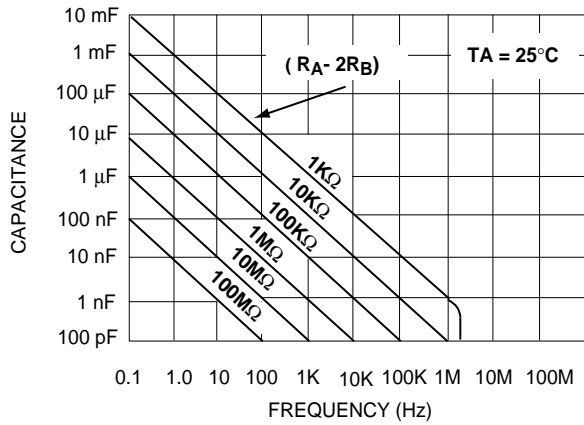

**FREQUENCY CHANGE IN THE ASTABLE MODE AS A FUNCTION OF SUPPLY VOLTAGE**

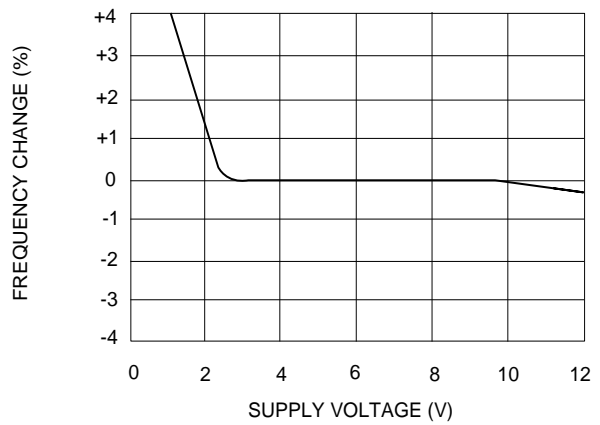

**TIME DELAY IN THE MONOSTABLE MODE AS A FUNCTION OF  $R_A$  AND C**

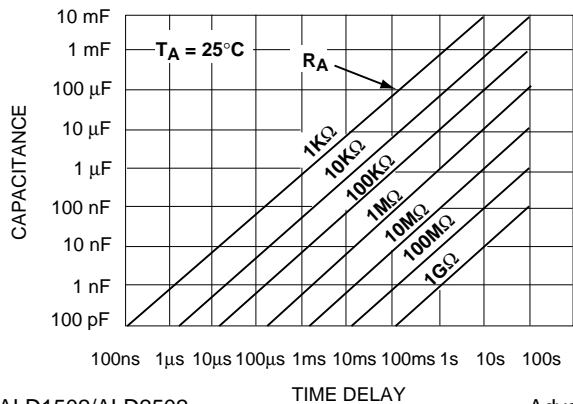

**SUPPLY CURRENT AS A FUNCTION OF SUPPLY VOLTAGE**

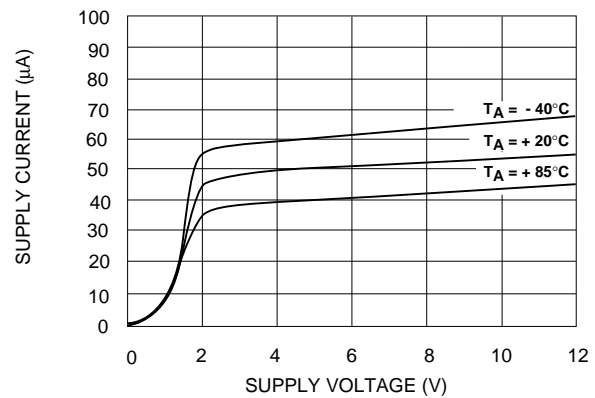

## TYPICAL PERFORMANCE CHARACTERISTICS

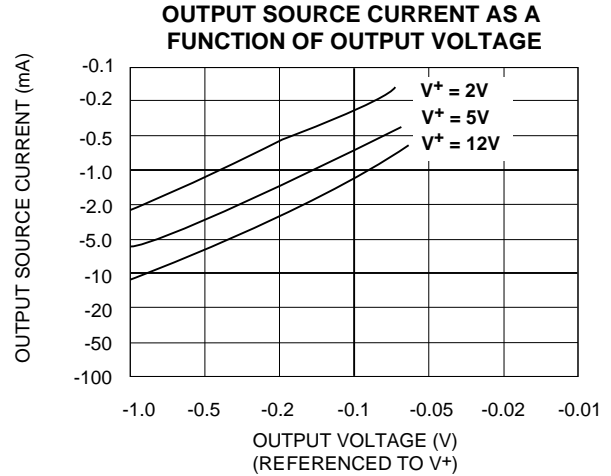
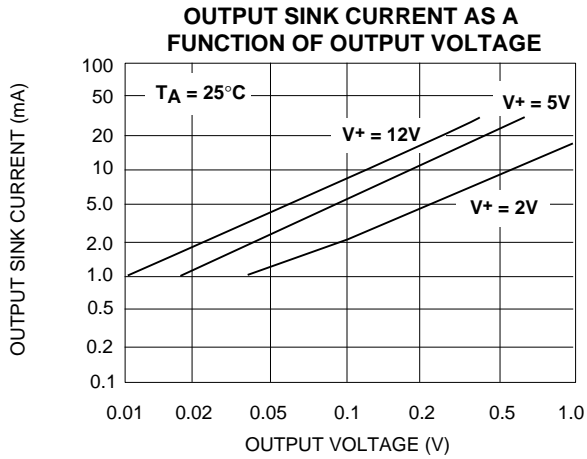

## TYPICAL APPLICATIONS ( EACH TIMER )

### ASTABLE MODE OPERATION 50% DUTY CYCLE

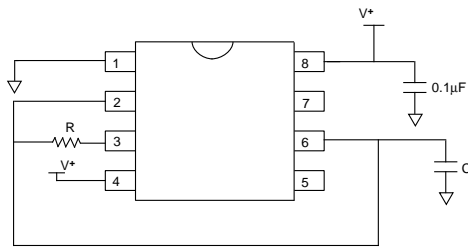

$$\text{Frequency } f = 1 / (1.4 RC)$$

### ASTABLE MODE OPERATION (FREE RUNNING OSCILLATOR)

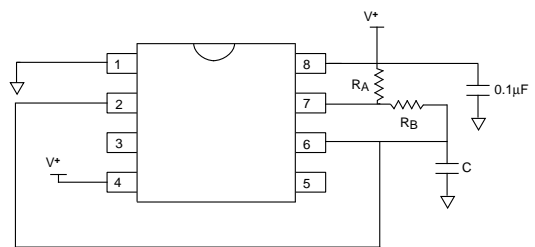

$$\text{Frequency } f = 1.46 / (R_A + 2R_B)C$$

$$\text{Duty Cycle DC} = R_B / (R_A + 2R_B)$$

### MONOSTABLE MODE OPERATION (ONE SHOT PULSE)

Pulse Delay  $t_d = 1.1 R_C$

