

MAXIM

24V Internal Switch, 100% Duty Cycle, Step-Down Converters

General Description

The MAX1836/MAX1837 high-efficiency step-down converters provide a preset 3.3V or 5V output voltage from supply voltages as high as 24V. Using external feedback resistors, the output voltage may be adjusted from 1.25V to V_{IN} . An internal current-limited switching MOSFET delivers load currents up to 125mA (MAX1836) or 250mA (MAX1837).

The unique current-limited control scheme, operating with duty cycles up to 100%, minimizes the dropout voltage (120mV at 100mA). Additionally, this control scheme reduces supply current under light loads to 12 μ A. High switching frequencies allow the use of tiny surface-mount inductors and output capacitors.

The MAX1836/MAX1837 step-down converters with internal switching MOSFETs are available in a 6-pin SOT23 package, making them ideal for low-cost, low-power, space-sensitive applications. For increased output drive capability, use the MAX1776 step-down converter that uses an internal 24V switch to deliver up to 500mA. For even higher currents, use the MAX1626/MAX1627 step-down controllers that drive an external P-channel MOSFET to deliver up to 20W.

Applications

- 9V Battery Systems
- Notebook Computers
- Distributed Power Systems
- Backup Supplies
- 4mA to 20mA Loop Power Supplies
- Industrial Control Supplies
- Hand-Held Devices

Typical Operating Circuit

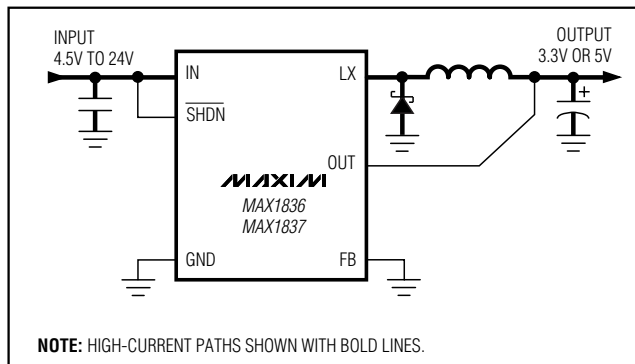

Features

- ◆ 4.5V to 24V Input Voltage Range
- ◆ Preset 3.3V or 5V Output
- ◆ Adjustable Output from 1.25V to V_{IN}
- ◆ Output Currents Up to 125mA (MAX1836) or 250mA (MAX1837)
- ◆ Internal P-Channel MOSFET
- ◆ Efficiency Over 90%
- ◆ 12 μ A Quiescent Current
- ◆ 3 μ A Shutdown Current
- ◆ 100% Maximum Duty Cycle for Low Dropout
- ◆ Current-Limiting and Overtemperature Protection
- ◆ Small 6-Pin SOT23 Package

Ordering Information

PART	TEMP RANGE	PIN-PACKAGE	TOP MARK
MAX1836EUT50-T	-40°C to +85°C	6 SOT23-6	AANW
MAX1836EUT33-T	-40°C to +85°C	6 SOT23-6	AANY
MAX1837EUT50-T	-40°C to +85°C	6 SOT23-6	AANX
MAX1837EUT33-T	-40°C to +85°C	6 SOT23-6	AANZ

Note: The MAX1836/MAX1837 require special solder temperature profile described in the Absolute Maximum Ratings.

Selector Guide

PART	PRESET OUTPUT VOLTAGE (V)	LOAD CURRENT (mA)
MAX1836EUT50	5	125
MAX1836EUT33	3.3	125
MAX1837EUT50	5	250
MAX1837EUT33	3.3	250

Pin Configuration

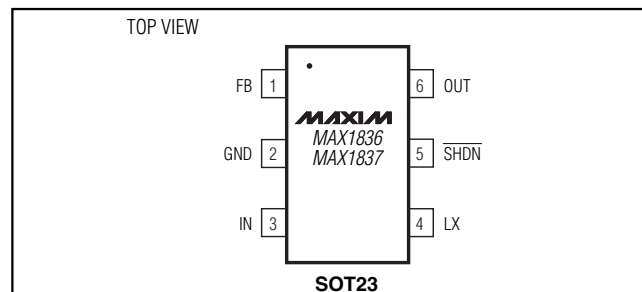
**MAXIM**

Maxim Integrated Products 1

For pricing, delivery, and ordering information, please contact Maxim/Dallas Direct! at 1-888-629-4642, or visit Maxim's website at www.maxim-ic.com.

MAX1836/MAX1837

24V Internal Switch, 100% Duty Cycle, Step-Down Converters

ABSOLUTE MAXIMUM RATINGS

IN, $\overline{\text{SHDN}}$ to GND-0.3V to +25V
 LX to GND-2V to ($V_{\text{IN}} + 0.3\text{V}$)
 OUT, FB to GND-0.3V to +6V
 Continuous Power Dissipation ($T_{\text{A}} = +70^{\circ}\text{C}$) (Note 1)
 6-Pin SOT23 (derate 8.7mW/ $^{\circ}\text{C}$ above +70 $^{\circ}\text{C}$)696mW

Operating Temperature Range-40 $^{\circ}\text{C}$ to +85 $^{\circ}\text{C}$
 Junction Temperature+150 $^{\circ}\text{C}$
 Storage Temperature Range-65 $^{\circ}\text{C}$ to +150 $^{\circ}\text{C}$
 Lead Temperature (soldering, 10s)+300 $^{\circ}\text{C}$

Note 1: Thermal properties are specified with product mounted on PC board with 1in² of copper area and still air.

Stresses beyond those listed under "Absolute Maximum Ratings" may cause permanent damage to the device. These are stress ratings only, and functional operation of the device at these or any other conditions beyond those indicated in the operational sections of the specifications is not implied. Exposure to absolute maximum rating conditions for extended periods may affect device reliability.

ELECTRICAL CHARACTERISTICS

(Circuits of Figures 1 (MAX1836) and 2 (MAX1837), $V_{\text{IN}} = 12\text{V}$, $\overline{\text{SHDN}} = \text{IN}$, $T_{\text{A}} = 0^{\circ}\text{C}$ to +85 $^{\circ}\text{C}$. Typical values are at $T_{\text{A}} = +25^{\circ}\text{C}$, unless otherwise noted.)

PARAMETER	SYMBOL	CONDITIONS		MIN	TYP	MAX	UNITS
Input Supply Range	V_{IN}			4.5		24	V
Input Undervoltage Lockout Threshold	V_{UVLO}	V_{IN} rising		3.55	4.0	4.4	V
		V_{IN} falling		3.45	3.9	4.3	
Input Supply Current	I_{IN}				12	25	μA
Input Supply Current in Dropout	$I_{\text{IN(DROP)}}$	$V_{\text{IN}} = 5\text{V}$			18		μA
Input Shutdown Current		$\overline{\text{SHDN}} = \text{GND}$			3	7	μA
Output Voltage (Preset Mode)	V_{OUT}	FB = GND, $I_{\text{LOAD}} = 0$ to 125mA (MAX1836) or 250mA (MAX1837)	MAX183_EUT50	4.80	5.00	5.20	V
			MAX183_EUT33	3.168	3.30	3.432	
Output Voltage Range (Adjustable Mode)	V_{OUT}	(Note 2)		1.25		V_{IN}	V
Feedback Set Voltage (Adjustable Mode)	V_{FB}			1.200	1.25	1.300	V
OUT Bias Current		$V_{\text{OUT}} = 5\text{V}$			2.5	7.4	μA
FB Bias Current	I_{FB}	$V_{\text{FB}} = 0$ or 1.25V, $T_{\text{A}} = +25^{\circ}\text{C}$		-25		+25	nA
FB Dual Mode™ Threshold		V_{FB} rising or falling		50	100	150	mV
LX Switch Minimum Off-Time	$t_{\text{OFF(MIN)}}$			0.2	0.4	0.6	μs
LX Switch Maximum On-Time	$t_{\text{ON(MAX)}}$	$V_{\text{FB}} = 1.3\text{V}$		7	10	13	μs
LX Switch On-Resistance	R_{LX}	$V_{\text{IN}} = 6\text{V}$			1.1	2	Ω
LX Current Limit	I_{LIM}	MAX1836		250	312	450	mA
		MAX1837		500	625	850	
LX Zero-Crossing Threshold				-75		+75	mV

Dual Mode is a trademark of Maxim Integrated Products, Inc.

24V Internal Switch, 100% Duty Cycle, Step-Down Converters

MAX1836/MAX1837

ELECTRICAL CHARACTERISTICS (continued)

(Circuits of Figures 1 (MAX1836) and 2 (MAX1837), $V_{IN} = 12V$, $\overline{SHDN} = IN$, $T_A = 0^{\circ}C$ to $+85^{\circ}C$. Typical values are at $T_A = +25^{\circ}C$, unless otherwise noted.)

PARAMETER	SYMBOL	CONDITIONS	MIN	TYP	MAX	UNITS
Zero-Crossing Timeout		LX does not rise above the threshold		30		μs
LX Switch Leakage Current		$V_{IN} = 18V$, LX = GND, $T_A = +25^{\circ}C$			1	μA
Dropout Voltage	$V_{DROPOUT}$	$I_{OUT} = 100mA$, $V_{IN} = 5V$		120		mV
Line Regulation		$V_{IN} = 5V$ to $24V$		0.05		%
Load Regulation		$I_{OUT} = 0$ to $125mA$ (MAX1836) or $250mA$ (MAX1837)		0.3		%
Shutdown Input Threshold	$V_{\overline{SHDN}}$	$V_{IN} = 4.5V$ to $24V$ (Note 3)	0.8		2.4	V
Shutdown Leakage Current	$I_{\overline{SHDN}}$	$V_{\overline{SHDN}} = 0$ or $24V$	-1		+1	μA
Thermal Shutdown		$10^{\circ}C$ hysteresis (typ)		160		$^{\circ}C$

ELECTRICAL CHARACTERISTICS

(Circuits of Figures 1 (MAX1836) and 2 (MAX1837), $V_{IN} = 12V$, $\overline{SHDN} = IN$, $T_A = -40^{\circ}C$ to $+85^{\circ}C$, unless otherwise noted.) (Note 4)

PARAMETER	SYMBOL	CONDITIONS	MIN	TYP	MAX	UNITS	
Input Supply Range	V_{IN}		4.5		24	V	
Input Undervoltage Lockout Threshold	V_{UVLO}	V_{IN} rising	3.55		4.4	V	
		V_{IN} falling	3.45		4.3		
Input Supply Current	I_{IN}				25	μA	
Input Shutdown Current		$\overline{SHDN} = GND$			7	μA	
Output Voltage (Preset Mode)	V_{OUT}	FB = GND, $I_{LOAD} = 0$ to $125mA$ (MAX1836) or $250mA$ (MAX1837)	MAX183_EUT50	4.80		5.20	V
			MAX183_EUT33	3.168		3.432	
Output Voltage Range (Adjustable Mode)	V_{OUT}	(Note 2)	1.25		V_{IN}	V	
Feedback Set Voltage (Adjustable Mode)	V_{FB}		1.200		1.300	V	
OUT Bias Current		$V_{OUT} = 5V$			7.4	μA	
FB Dual Mode Threshold		V_{FB} rising or falling	50		150	mV	
LX Switch Minimum Off-Time	$t_{OFF(MIN)}$		0.2		0.6	μs	
LX Switch Maximum On-Time	$t_{ON(MAX)}$	$V_{FB} = 1.3V$	7		13	μs	
LX Switch On-Resistance	R_{LX}	$V_{IN} = 6V$			2	Ω	
LX Current Limit	I_{LIM}	MAX1836	250		450	mA	
		MAX1837	500		900		

24V Internal Switch, 100% Duty Cycle, Step-Down Converters

ELECTRICAL CHARACTERISTICS (continued)

(Circuits of Figures 1 (MAX1836) and 2 (MAX1837), $V_{IN} = 12V$, $SHDN = IN$, $T_A = -40^{\circ}C$ to $+85^{\circ}C$, unless otherwise noted.) (Note 4)

PARAMETER	SYMBOL	CONDITIONS	MIN	TYP	MAX	UNITS
LX Zero-Crossing Threshold			-75	+75		mV
Shutdown Input Threshold	V_{SHDN}	$V_{IN} = 4.5V$ to $24V$ (Note 3)	0.8		2.4	V
Shutdown Leakage Current	I_{SHDN}	$V_{SHDN} = 0$ or $24V$	-1		+1	μA

Note 2: When using the shutdown input, the maximum output voltage allowed with external feedback is 5.5V. If the output voltage is set above 5.5V, connect shutdown to the input.

Note 3: Shutdown input minimum slew rate (rising or falling) is 10V/ms.

Note 4: Specifications to $-40^{\circ}C$ are guaranteed by design, not production tested.

Typical Operating Characteristics

(Circuits of Figures 1 (MAX1836) and 2 (MAX1837), $V_{IN} = 12V$, $SHDN = IN$, $T_A = +25^{\circ}C$.)

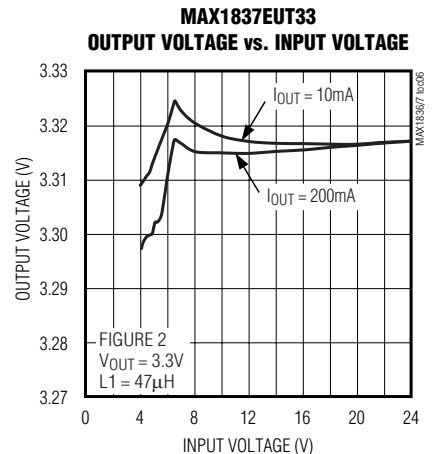
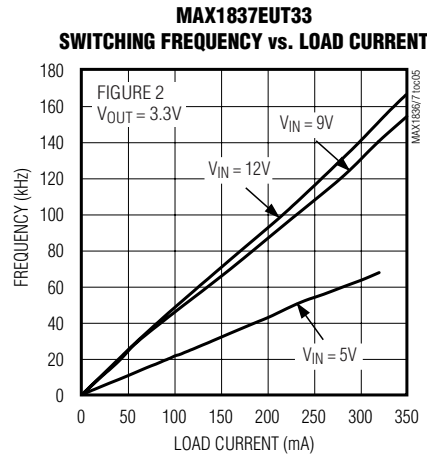
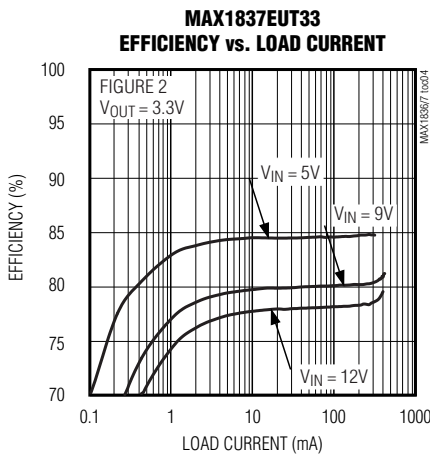
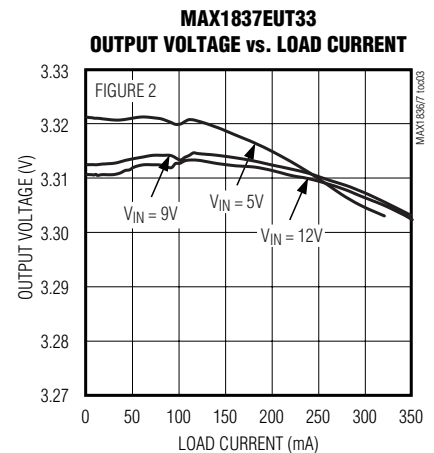
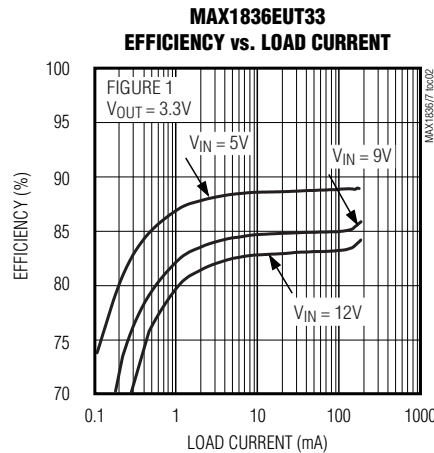
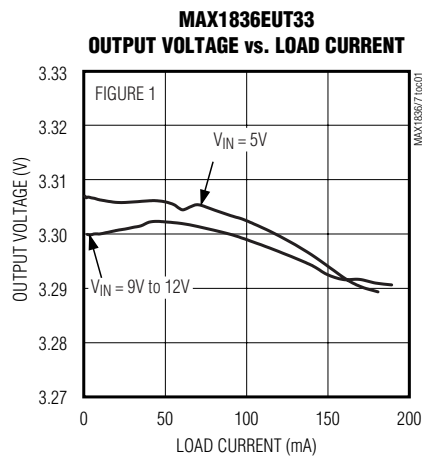

24V Internal Switch, 100% Duty Cycle, Step-Down Converters

Typical Operating Characteristics (continued)

(Circuits of Figures 1 (MAX1836) and 2 (MAX1837), $V_{IN} = 12V$, $\overline{SHDN} = IN$, $T_A = +25^\circ C$.)

MAX1836/MAX1837

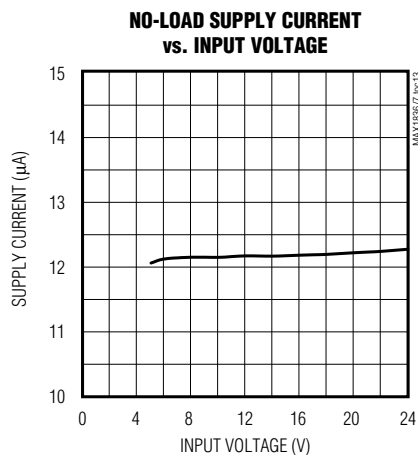
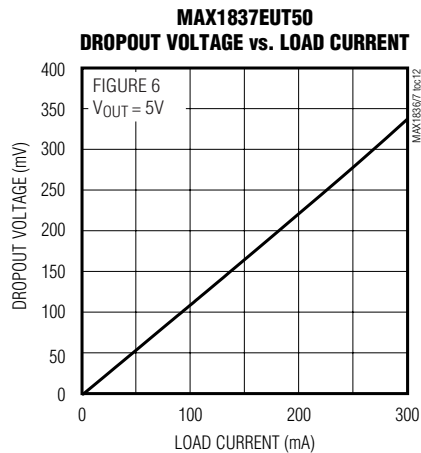
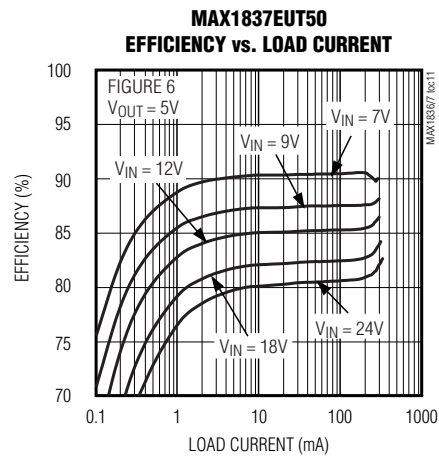
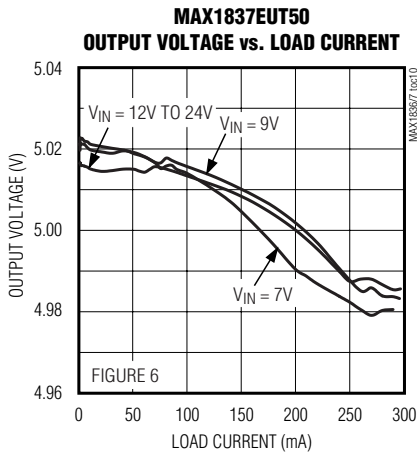
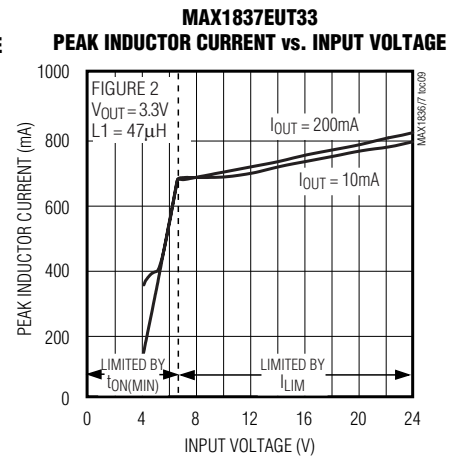
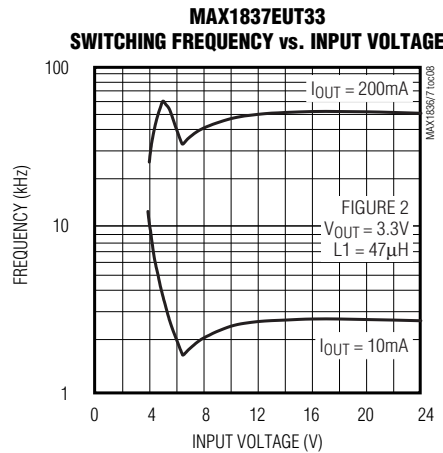
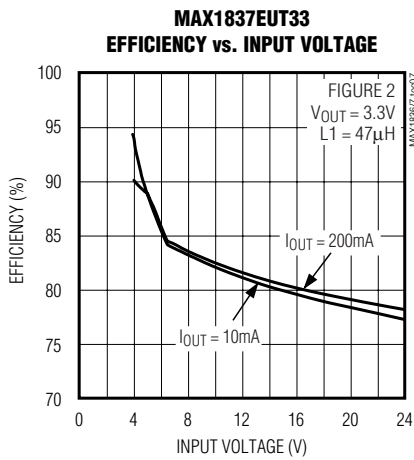

24V Internal Switch, 100% Duty Cycle, Step-Down Converters

Typical Operating Characteristics (continued)

(Circuits of Figures 1 (MAX1836) and 2 (MAX1837), $V_{IN} = 12V$, $\overline{SHDN} = IN$, $T_A = +25^\circ C$.)

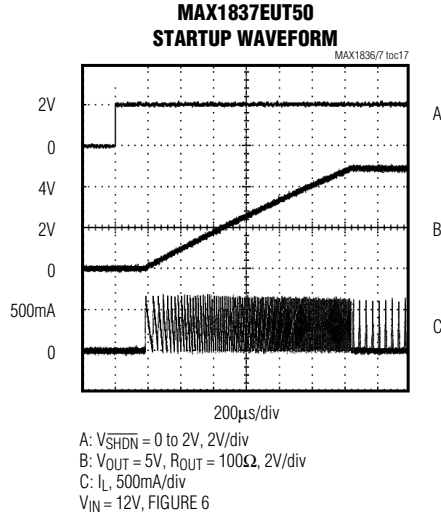
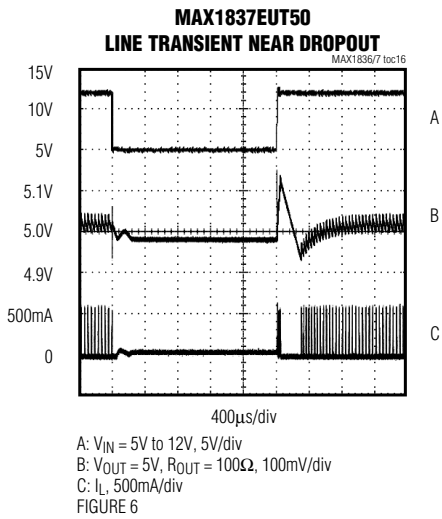
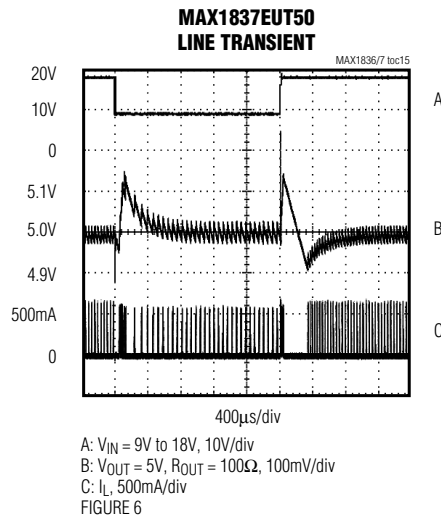
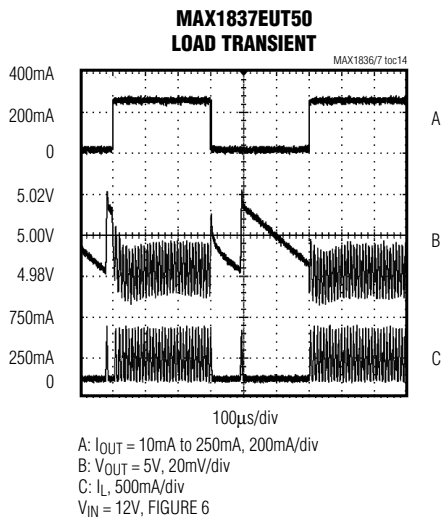

24V Internal Switch, 100% Duty Cycle, Step-Down Converters

Pin Description

MAX1836/MAX1837

PIN	NAME	FUNCTION
1	FB	Dual-Mode Feedback Input. Connect to GND for the preset 3.3V (MAX183_EUT33) or 5.0V (MAX183_EUT50) output. Connect to a resistive divider between the output and FB to adjust the output voltage between 1.25V and VIN, and connect the OUT pin to GND. When setting output voltages above 5.5V, permanently connect SHDN to IN.
2	GND	Ground
3	IN	Input Voltage. 4.5V to 24V input range. Connected to the internal P-channel power MOSFET's source.
4	LX	Inductor Connection. Connected to the internal P-channel power MOSFET's drain.
5	SHDN	Shutdown Input. A logic low shuts down the MAX1836/MAX1837 and reduces supply current to 3μA. LX is high impedance in shutdown. Connect to IN for normal operation. When setting output voltages above 5.5V, permanently connect SHDN to IN.
6	OUT	Regulated Output Voltage High-Impedance Sense Input. Internally connected to a resistive divider. Connect to the output when using the preset output voltage. Connect to GND when using an external resistive divider to adjust the output voltage.

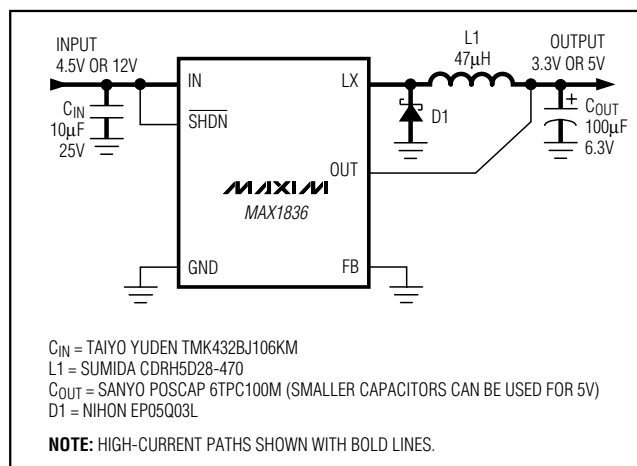

Figure 1. Typical MAX1836 Application Circuit

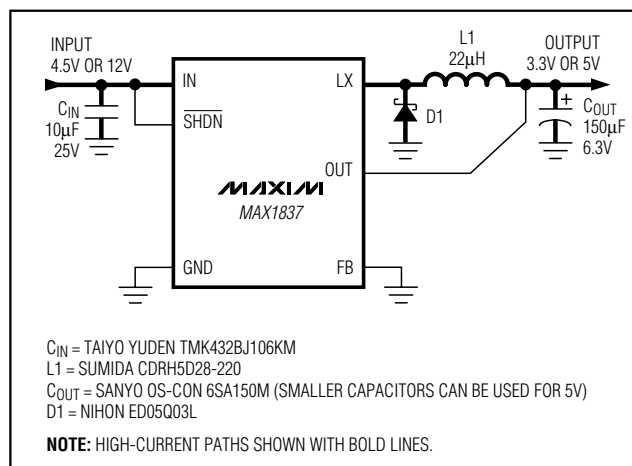

Figure 2. Typical MAX1837 Application Circuit

Detailed Description

The MAX1836/MAX1837 step-down converters are designed primarily for battery-powered devices, notebook computers, and industrial control applications. A unique current-limited control scheme provides high efficiency over a wide load range. Operation up to 100% duty cycle allows the lowest possible dropout voltage, increasing the useable supply voltage range. Under no-load, the MAX1836/MAX1837 draw only 12μA, and in shutdown mode, they draw only 3μA to further reduce power consumption and extend battery

life. Additionally, an internal 24V switching MOSFET, internal current sensing, and a high switching frequency minimize PC board space and component cost.

Current-Limited Control Architecture

The MAX1836/MAX1837 use a proprietary current-limited control scheme that operates with duty cycles up to 100%. These DC-DC converters pulse as needed to maintain regulation, resulting in a variable switching frequency that increases with the load. This eliminates the high supply currents associated with conventional con-

24V Internal Switch, 100% Duty Cycle, Step-Down Converters

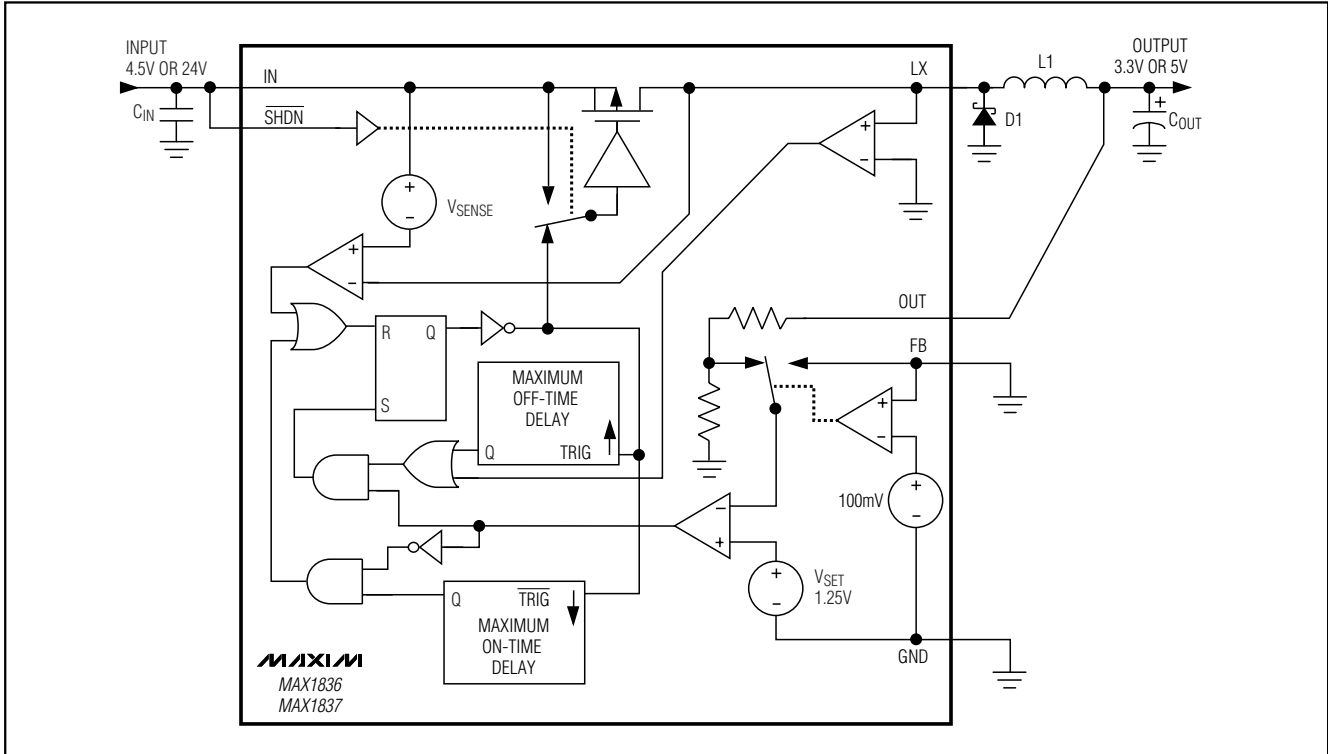

Figure 3. Functional Diagram

stant-frequency pulse-width-modulation (PWM) controllers that switch the MOSFET unnecessarily.

When the output voltage is too low, an error comparator sets a flip-flop, which turns on the internal P-channel MOSFET and begins a switching cycle (Figure 3). As shown in Figure 4, the inductor current ramps up linearly, charging the output capacitor and servicing the load. The MOSFET turns off when the current limit is reached, or when the maximum on-time is exceeded while the output voltage is in regulation. Otherwise, the MOSFET remains on, allowing a duty cycle up to 100% to ensure the lowest possible dropout voltage. Once the MOSFET turns off, the flip-flop resets, diode D1 turns on, and the current through the inductor ramps back down, transferring the stored energy to the output capacitor and load. The MOSFET remains off until the 0.5 μ s minimum off-time expires and the inductor current ramps down to zero, and the output voltage drops back below the set point.

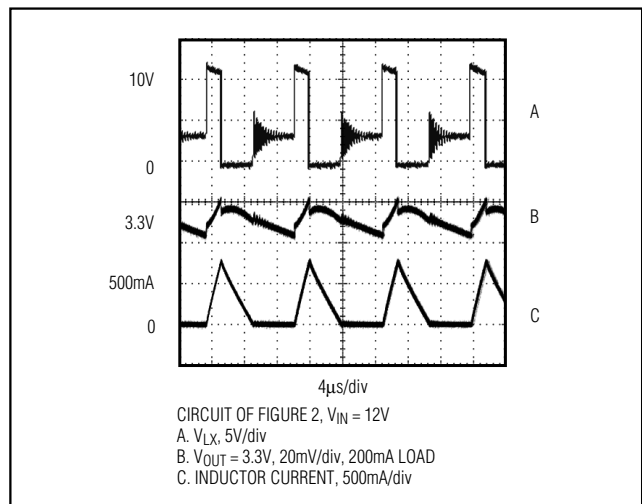

Figure 4. Discontinuous-Conduction Operation

24V Internal Switch, 100% Duty Cycle, Step-Down Converters

Input-Output (Dropout) Voltage

A step-down converter's minimum input-to-output voltage differential (dropout voltage) determines the lowest useable input supply voltage. In battery-powered systems, this limits the useful end-of-life battery voltage. To maximize battery life, the MAX1836/MAX1837 operate with duty cycles up to 100%, which minimizes the input-to-output voltage differential. When the supply voltage approaches the output voltage, the P-channel MOSFET remains on continuously to supply the load.

Dropout voltage is defined as the difference between the input and output voltages when the input is low enough for the output to drop out of regulation. For a step-down converter with 100% duty cycle, the dropout voltage depends on the MOSFET drain-to-source on-resistance ($R_{DS(ON)}$) and inductor series resistance; therefore, it is proportional to the load current:

$$V_{DROPOUT} = I_{OUT} \times (R_{DS(ON)} + R_{INDUCTOR})$$

Shutdown (\overline{SHDN})

A logic-level low voltage on \overline{SHDN} shuts down the MAX1836/MAX1837. When shut down, the supply current drops to 3 μ A to maximize battery life, and the internal P-channel MOSFET turns off to isolate the output from the input. The output capacitance and load current determine the rate at which the output voltage decays. A logic-level high voltage on \overline{SHDN} activates the MAX1836/MAX1837. Do not leave \overline{SHDN} floating. If unused, connect \overline{SHDN} to IN. When setting output voltages above 5.5V, the shutdown feature cannot be used, so \overline{SHDN} must be permanently connected to IN. The \overline{SHDN} input voltage slew rate must be greater than 10V/ms.

Thermal-Overload Protection

Thermal-overload protection limits total power dissipation in the MAX1836/MAX1837. When the junction temperature exceeds $T_J = +160^\circ\text{C}$, a thermal sensor turns off the pass transistor, allowing the IC to cool. The thermal sensor turns the pass transistor on again after the IC's junction temperature cools by 10°C , resulting in a pulsed output during continuous thermal-overload conditions.

Design Information

Output Voltage Selection

The feedback input features dual-mode operation. Connect the output to OUT and FB to GND for the preset output voltage. The MAX1836/MAX1837 are supplied with factory-set output voltages of 3.3V or 5V. The two-digit part number suffix identifies the output voltage

(see the *Selector Guide*). For example, the MAX1836EUT33 has a preset 3.3V output voltage.

The MAX1836/MAX1837 output voltage may be adjusted by connecting a voltage divider from the output to FB (Figure 5). When externally adjusting the output voltage, connect OUT to GND. Select R2 in the 10k Ω to 100k Ω range. Calculate R1 with the following equation:

$$R1 = R2 \left[\left(\frac{V_{OUT}}{V_{FB}} \right) - 1 \right]$$

where $V_{FB} = 1.25\text{V}$, and V_{OUT} may range from 1.25V to V_{IN} . When setting output voltages above 5.5V, the shutdown feature cannot be used, so \overline{SHDN} must be permanently connected to IN.

Inductor Selection

When selecting the inductor, consider these four parameters: inductance value, saturation current rating, series resistance, and size. The MAX1836/MAX1837 operate with a wide range of inductance values. For most applications, values between 10 μ H and 100 μ H work best with the controller's switching frequency. Calculate the minimum inductance value as follows:

$$L_{(MIN)} = \frac{(V_{IN(MAX)} - V_{OUT})t_{ON(MIN)}}{I_{LIM}}$$

where $t_{ON(MIN)} = 1.0\mu\text{s}$. Inductor values up to six times $L_{(MIN)}$ are acceptable. Low-value inductors may be smaller in physical size and less expensive, but they result in higher peak-current overshoot due to current-sense comparator propagation delay (300ns). Peak-current overshoot reduces efficiency and could exceed the current ratings of the internal switching MOSFET and external components.

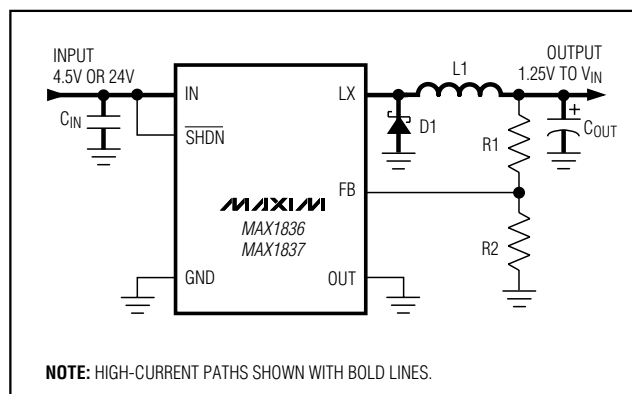

Figure 5. Adjustable Output Voltage

24V Internal Switch, 100% Duty Cycle, Step-Down Converters

The inductor's saturation current rating must be greater than the peak switching current, which is determined by the switch current limit plus the overshoot due to the 300ns current-sense comparator propagation delay:

$$I_{PEAK} = I_{LIM} + \frac{(V_{IN} - V_{OUT}) 300ns}{L}$$

where the switch current-limit (I_{LIM}) is typically 312mA (MAX1836) or 625mA (MAX1837). Saturation occurs when the inductor's magnetic flux density reaches the maximum level the core can support, and the inductance starts to fall.

Inductor series resistance affects both efficiency and dropout voltage (see the *Input-Output Voltage* section). High series resistance limits the maximum current available at lower input voltages and increases the dropout voltage. For optimum performance, select an inductor with the lowest possible DC resistance that fits in the allotted dimensions. Typically, the inductor's series resistance should be significantly less than that of the internal P-channel MOSFET's on-resistance (1.1 Ω typ). Inductors with a ferrite core, or equivalent, are recommended.

The maximum output current of the MAX1836/MAX1837 current-limited converter is limited by the peak inductor current. For the typical application, the maximum output current is approximately:

$$I_{OUT(MAX)} = \frac{1}{2} I_{PEAK}$$

Output Capacitor

Choose the output capacitor to supply the maximum load current with acceptable voltage ripple. The output ripple has two components: variations in the charge stored in the output capacitor with each LX pulse, and the voltage drop across the capacitor's equivalent series resistance (ESR) caused by the current into and out of the capacitor:

$$V_{RIPPLE} \approx V_{RIPPLE(ESR)} + V_{RIPPLE(C)}$$

The output voltage ripple as a consequence of the ESR and output capacitance is:

$$V_{RIPPLE(ESR)} = I_{PEAK} ESR$$

$$V_{RIPPLE(C)} = \frac{L(I_{PEAK} - I_{OUT})^2}{2C_{OUT}V_{OUT}} \left(\frac{V_{IN}}{V_{IN} - V_{OUT}} \right)$$

where I_{PEAK} is the peak inductor current (see the *Inductor Selection* section). These equations are suit-

able for initial capacitor selection, but final values should be set by testing a prototype or evaluation circuit. As a general rule, a smaller amount of charge delivered in each pulse results in less output ripple. Since the amount of charge delivered in each oscillator pulse is determined by the inductor value and input voltage, the voltage ripple increases with larger inductance but decreases with lower input voltages.

With low-cost aluminum electrolytic capacitors, the ESR-induced ripple can be larger than that caused by the current into and out of the capacitor. Consequently, high-quality low-ESR aluminum-electrolytic, tantalum, polymer, or ceramic filter capacitors are required to minimize output ripple. Best results at reasonable cost are typically achieved with an aluminum-electrolytic capacitor in the 100 μ F range, in parallel with a 0.1 μ F ceramic capacitor.

Input Capacitor

The input filter capacitor reduces peak currents drawn from the power source and reduces noise and voltage ripple on the input caused by the circuit's switching. The input capacitor must meet the ripple-current requirement (I_{RMS}) imposed by the switching currents defined by the following equation:

$$I_{RMS} = I_{LOAD} \frac{\sqrt{V_{OUT}(V_{IN} - V_{OUT})}}{V_{IN}}$$

For most applications, nontantalum chemistries (ceramic, aluminum, polymer, or OS-CON) are preferred due to their robustness with high inrush currents typical of systems with low-impedance battery inputs. Alternatively, two (or more) smaller-value low-ESR capacitors can be connected in parallel for lower cost. Choose an input capacitor that exhibits $<+10^{\circ}\text{C}$ temperature rise at the RMS input current for optimal circuit longevity.

Diode Selection

The current in the external diode (D1) changes abruptly from zero to its peak value each time the LX switch turns off. To avoid excessive losses, the diode must have a fast turn-on time and a low forward voltage. Use a diode with an RMS current rating of 0.5A or greater, and with a breakdown voltage $>V_{IN}$. Schottky diodes are preferred. For high-temperature applications, Schottky diodes may be inadequate due to their high leakage currents. In such cases, ultra-high-speed silicon rectifiers are recommended, although a Schottky diode with a higher reverse voltage rating can often provide acceptable performance.

24V Internal Switch, 100% Duty Cycle, Step-Down Converters

MAX1836/MAX1837

Table 1. Component Suppliers

SUPPLIER	PHONE	FAX	WEBSITE
INDUCTORS			
Coilcraft	847-639-6400	847-639-1469	www.coilcraft.com
Coiltronics	561-241-7876	561-241-9339	www.coiltronics.com
Sumida USA	847-956-0666	847-956-0702	www.sumida.com
Toko	847-297-0070	847-699-1194	www.tokoam.com
CAPACITORS			
AVX	803-946-0690	803-626-3123	www.avxcorp.com
Kemet	408-986-0424	408-986-1442	www.kemet.com
Panasonic	847-468-5624	847-468-5815	www.panasonic.com
Sanyo	619-661-6835	619-661-1055	www.secc.co.jp
Taiyo Yuden	408-573-4150	408-573-4159	www.t-yuden.com
DIODES			
Central Semiconductor	516-435-1110	516-435-1824	www.centalsemi.com
International	310-322-3331	310-322-3332	www.irf.com
Nihon	847-843-7500	847-843-2798	www.niec.co.jp
On Semiconductor	602-303-5454	602-994-6430	www.onsemi.com
Zetex	516-543-7100	516-864-7630	www.zetex.com

MAX1836/MAX1837 Stability

Commonly, instability is caused by excessive noise on the feedback signal or ground due to poor layout or improper component selection. When seen, instability typically manifests itself as “motorboating,” which is characterized by grouped switching pulses with large gaps and excessive low-frequency output ripple during no-load or light-load conditions.

PC Board Layout and Grounding

High switching frequencies and large peak currents make PC board layout an important part of the design. Poor layout may introduce switching noise into the feedback path, resulting in jitter, instability, or degraded performance. High-power traces, bolded in the typical application circuits (Figures 1 and 2), should be as short and wide as possible. Additionally, the current loops formed by the power components (C_{IN} , C_{OUT} , L1, and D1) should be as tight as possible to avoid radiated noise. Connect the ground pins of these power components at a common node in a star-ground configuration. Separate the noisy traces, such as the LX node, from the feedback network with grounded copper. Furthermore, keep the extra copper on the board, and integrate it into a pseudoground plane. When using external feedback, place the resistors as close to the feedback pin as possible to minimize noise

coupling. The MAX1837 evaluation kit shows the recommended layout.

Applications Information

High-Voltage Step-Down Converter

The typical application circuits' (Figures 1 and 2) components were selected for 9V battery applications. However, the MAX1836/MAX1837 input voltage range allows supply voltages up to 24V. Figure 6 shows a modified application circuit for high-voltage applications. When using higher input voltages, verify that the input capacitor's voltage rating exceeds $V_{IN(MAX)}$ and that the inductor value exceeds the minimum inductance recommended in the *Inductor Selection* section.

Inverter Configuration

Figure 7 shows the MAX1836/MAX1837 in a floating ground configuration. By connecting what would normally be the output to the supply-voltage ground, the IC's ground pin is forced to regulate to -5V (MAX183_EUT50) or -3.3V (MAX183_EUT33). Avoid exceeding the maximum ratings of 24V between IN and GND, and 5.5V between OUT and GND. Other negative voltages may be generated by placing a resistive divider across the output capacitor and connecting the tap to FB in the same manner as the normal step-down configuration.

24V Internal Switch, 100% Duty Cycle, Step-Down Converters

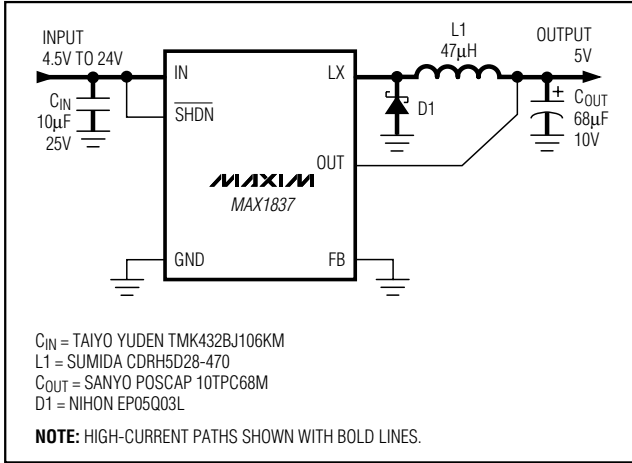

Figure 6. High-Voltage Application

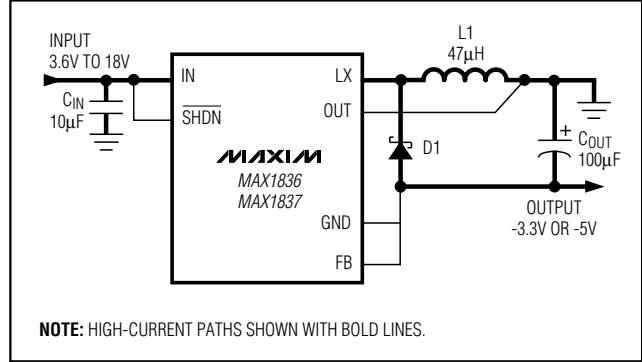

Figure 7. MAX1836/MAX1837 Inverter Configuration

Chip Information

TRANSISTOR COUNT: 731

PROCESS: BiCMOS

24V Internal Switch, 100% Duty Cycle, Step-Down Converters

Package Information

(The package drawing(s) in this data sheet may not reflect the most current specifications. For the latest package outline information, go to www.maxim-ic.com/packages.)

MAX1836/MAX1837

6LSOT-EPS

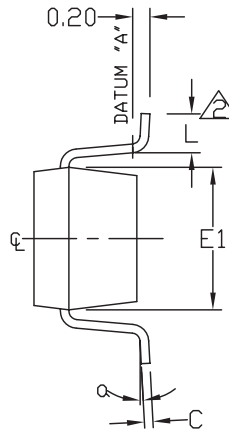
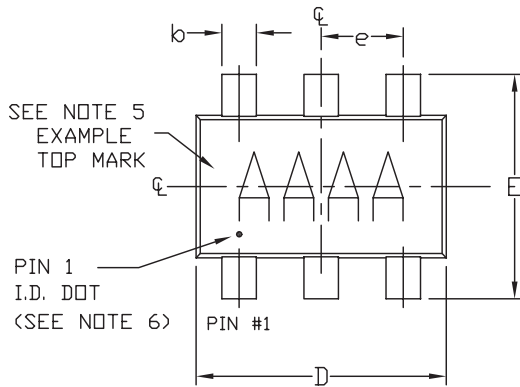

SYMBOL	MIN	MAX
A	0.90	1.45
A1	0.00	0.15
A2	0.90	1.30
b	0.35	0.50
C	0.08	0.20
D	2.80	3.00
E	2.60	3.00
E1	1.50	1.75
L	0.35	0.55
e	0.95 REF	
a	0°	10°

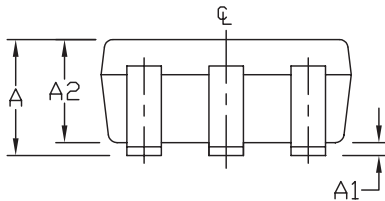

NOTES:

- ALL DIMENSIONS ARE IN MILLIMETERS.
- FOOT LENGTH MEASURED AT INTERCEPT POINT BETWEEN DATUM A & LEAD SURFACE.
- PACKAGE OUTLINE EXCLUSIVE OF MOLD FLASH & METAL BURR.
- PACKAGE OUTLINE INCLUSIVE OF SOLDER PLATING.
- PIN 1 IS LOWER LEFT PIN WHEN READING TOP MARK FROM LEFT TO RIGHT. (SEE EXAMPLE TOP MARK)
- PIN 1 I.D. DOT IS 0.3 MM ϕ MIN. LOCATED ABOVE PIN 1.
- MEETS JEDEC MO178.

MAXIM		
PROPRIETARY INFORMATION		
TITLE:		
PACKAGE OUTLINE, SOT-23, 6L		
APPROVAL	DOCUMENT CONTROL NO.	REV
	21-0058	E 1/1

Maxim cannot assume responsibility for use of any circuitry other than circuitry entirely embodied in a Maxim product. No circuit patent licenses are implied. Maxim reserves the right to change the circuitry and specifications without notice at any time.

Maxim Integrated Products, 120 San Gabriel Drive, Sunnyvale, CA 94086 408-737-7600 13