

MAIN FEATURES:

| Symbol | Value | Unit |
|-------------------|-------------|---------|
| $I_{T(RMS)}$ | 0.8 | A |
| V_{DRM}/V_{RRM} | 400 and 600 | V |
| I_{GT} | 5 to 200 | μ A |

DESCRIPTION

Thanks to highly sensitive triggering levels, the P01 SCR series is suitable for all applications where available gate current is limited, such as ground fault circuit interruptors, pilot circuits in solid state relays, stand-by mode power supplies, smoke and alarm detectors.

Available in through-hole or surface mount packages, the voltage capability of this series has been upgraded since its introduction, to reach 600 V.

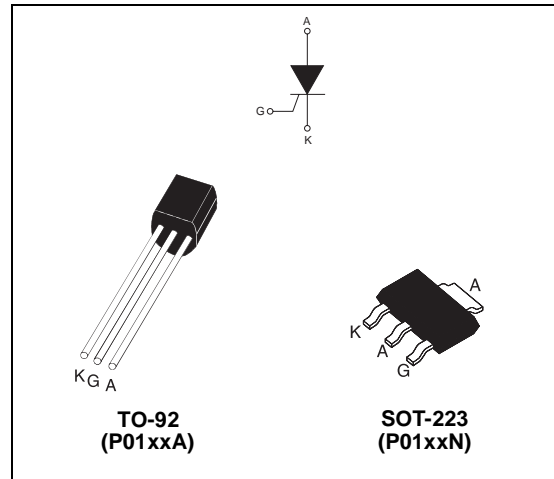
ABSOLUTE RATINGS (limiting values)

| Symbol | Parameter | Value | Unit |
|-----------------|--|--------------------------|--------------------------------------|
| $I_{T(RMS)}$ | RMS on-state current (180° conduction angle) | TO-92 Tl = 55°C | 0.8 A |
| | | SOT-223 Tamb = 70°C | |
| $I_{T(AV)}$ | Average on-state current (180° conduction angle) | TO-92 Tl = 55°C | 0.5 A |
| | | SOT-223 Tamb = 70°C | |
| I_{TSM} | Non repetitive surge peak on-state current | tp = 8.3 ms Tj = 25°C | 8 A |
| | | tp = 10 ms | |
| I_t^2 | I_t^2 Value for fusing | tp = 10ms Tj = 25°C | 0.24 A ² S |
| di/dt | Critical rate of rise of on-state current $I_G = 2 \times I_{GT}$, tr ≤ 100 ns | F = 60 Hz Tj = 125°C | 50 A/μs |
| I_{GM} | Peak gate current | tp = 20 μs Tj = 125°C | 1 A |
| $P_{G(AV)}$ | Average gate power dissipation | Tj = 125°C | 0.1 W |
| T_{stg} Tj | Storage junction temperature range Operating junction temperature range | | - 40 to + 150 - 40 to + 125 °C |

P01 Series

ELECTRICAL CHARACTERISTICS (T_j = 25°C, unless otherwise specified)

| Symbol | Test Conditions | | | P01xx | | | Unit | |
|--------------------------------------|--|------------------------|------------------------|------------------------|------|------|------|------|
| | | | | 02 | 11 | 18 | | |
| I _{GT} | V _D = 12 V R _L = 140 Ω | | | MIN. | - | 4 | 0.5 | μA |
| | | | | MAX. | 200 | 25 | 5 | |
| V _{GT} | | | | MAX. | 0.8 | | V | |
| V _{GD} | V _D = V _{DRM} R _L = 3.3 kΩ R _{GK} = 1 kΩ | T _j = 125°C | | MIN. | 0.1 | | V | |
| V _{RG} | I _{RG} = 10 μA | | | MIN. | 8 | | V | |
| I _H | I _T = 50 mA R _{GK} = 1 kΩ | | | MAX. | 5 | | mA | |
| I _L | I _G = 1 mA R _{GK} = 1 kΩ | | | MAX. | 6 | | mA | |
| dV/dt | V _D = 67 % V _{DRM} R _{GK} = 1 kΩ | T _j = 125°C | | MIN. | 75 | 80 | 75 | V/μs |
| V _{TM} | I _{TM} = 1.6 A tp = 380 μs | | T _j = 25°C | MAX. | 1.95 | | V | |
| V _{t0} | Threshold voltage | | | T _j = 125°C | MAX. | 0.95 | | V |
| R _d | Dynamic resistance | | | T _j = 125°C | MAX. | 600 | | mΩ |
| I _{DRM} I _{RDM} | V _{DRM} = V _{RDM} = 400 V R _{GK} = 1 kΩ | | T _j = 25°C | MAX. | 1 | | μA | |
| | V _{DRM} = V _{RDM} = 600 V R _{GK} = 1 kΩ | | | | 10 | | μA | |
| | V _{DRM} = V _{RDM} R _{GK} = 1 kΩ | | T _j = 125°C | MAX. | 100 | | μA | |

THERMAL RESISTANCES

| Symbol | Parameter | Value | Unit | |
|----------------------|-----------------------|-----------------------|---------|------|
| R _{th(j-i)} | Junction to case (DC) | TO-92 | 80 | °C/W |
| R _{th(j-t)} | Junction to tab (DC) | SOT-223 | 30 | °C/W |
| R _{th(j-a)} | Junction to ambient | TO-92 | 150 | |
| | | S = 5 cm ² | SOT-223 | 60 |

S = Copper surface under tab

PRODUCT SELECTOR

| Part Number | Voltage | | Sensitivity | Package |
|-------------|---------|-------|-------------|---------|
| | 400 V | 600 V | | |
| P0102DA | X | | 200 μA | TO-92 |
| P0102DN | X | | 200 μA | SOT-223 |
| P0102MA | | X | 200 μA | TO-92 |
| P0102MN | | X | 200 μA | SOT-223 |
| P0111DA | X | | 25 μA | TO-92 |
| P0111DN | X | | 25 μA | SOT-223 |
| P0111MA | | X | 25 μA | TO-92 |
| P0111MN | | X | 25 μA | SOT-223 |
| P0118DA | X | | 5 μA | TO-92 |
| P0118DN | X | | 5 μA | SOT-223 |
| P0118MA | | X | 5 μA | TO-92 |
| P0118MN | | X | 5 μA | SOT-223 |

ORDERING INFORMATION

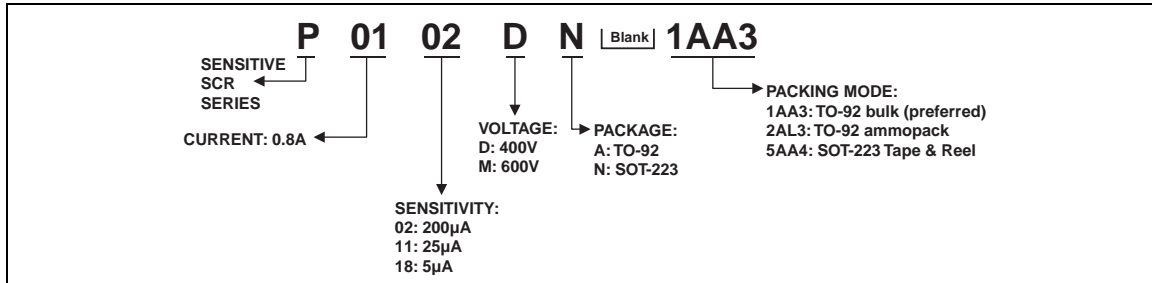

OTHER INFORMATION

| Part Number | Marking | Weight | Base Quantity | Packing mode |
|--------------|---------|--------|---------------|--------------|
| P01xxyA 1AA3 | P01xxyA | 0.2 g | 2500 | Bulk |
| P01xxyA 2AL3 | P01xxyA | 0.2 g | 2000 | Ampack |
| P0102yN 5AA4 | P2y | 0.12 g | 1000 | Tape & reel |
| P0111yN 5AA4 | P1y | 0.12 g | 1000 | Tape & reel |
| P0118yN 5AA4 | P8y | 0.12 g | 1000 | Tape & reel |

Note: xx = sensitivity, y = voltage

Fig. 1: Maximum average power dissipation versus average on-state current.

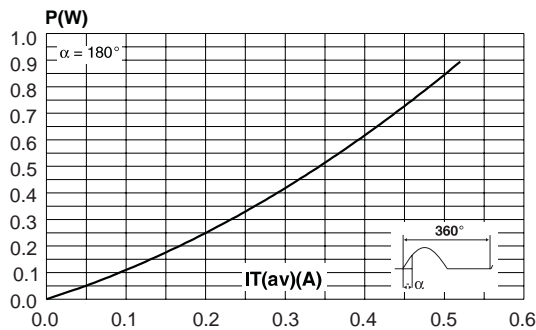

Fig. 2-2: Average and D.C. on-state current versus ambient temperature (device mounted on FR4 with recommended pad layout for SOT-223).

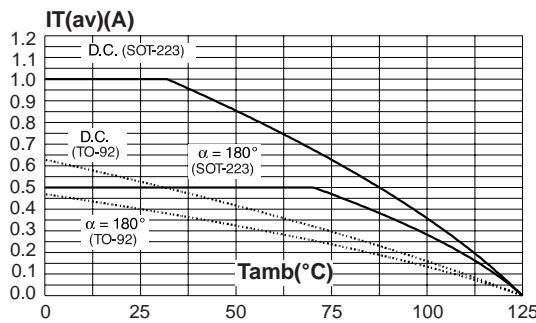

Fig. 2-1: Average and D.C. on-state current versus lead temperature.

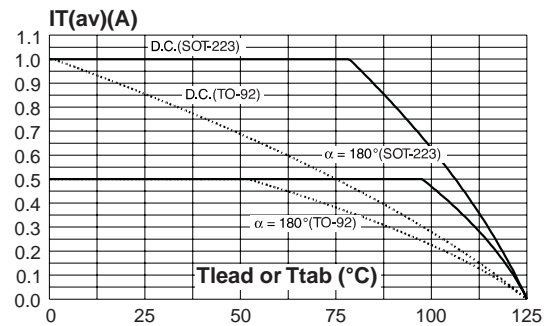

Fig. 3: Relative variation of thermal impedance junction to ambient versus pulse duration.

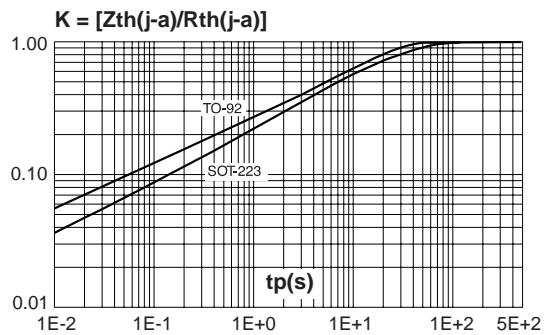

Fig. 4: Relative variation of gate trigger current, holding current and latching current versus junction temperature (typical values).

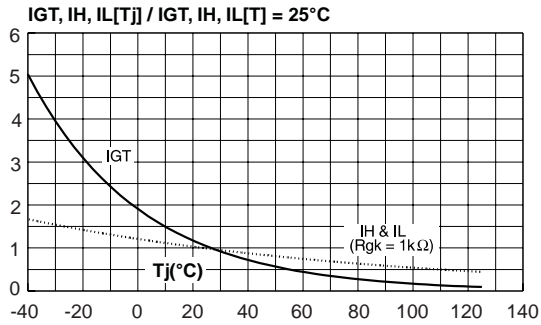

Fig. 6: Relative variation of dV/dt immunity versus gate-cathode resistance (typical values).

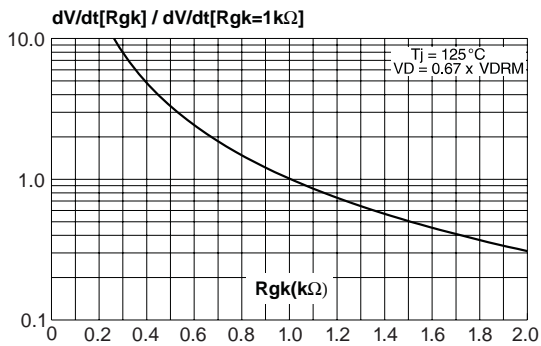

Fig. 8: Surge peak on-state current versus number of cycles.

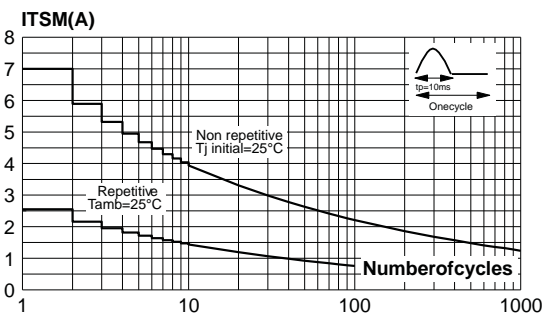

Fig. 5: Relative variation of holding current versus gate-cathode resistance (typical values).

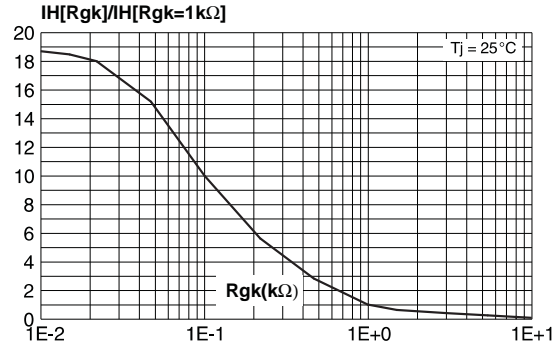

Fig. 7: Relative variation of dV/dt immunity versus gate-cathode capacitance (typical values).

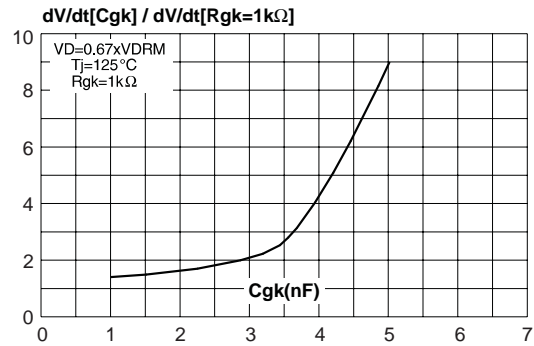

Fig. 9: Non-repetitive surge peak on-state current for a sinusoidal pulse with width $t_p < 10$ ms, and corresponding value of I^2t .

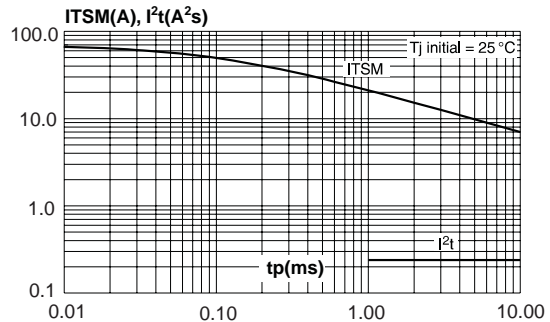

Fig. 10: On-state characteristics (maximum values).

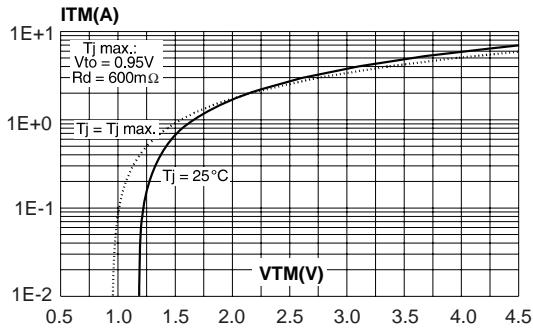
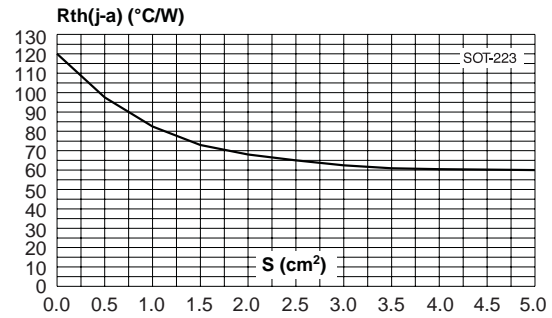

Fig. 11: SOT-223 Thermal resistance junction to ambient versus copper surface under tab (Epoxy printed circuit board FR4, copper thickness: $35\ \mu\text{m}$).



PACKAGE MECHANICAL DATA

TO-92 (Plastic)

The drawing shows a TO-92 package with dimensions labeled: A (width of the top flange), B (height of the top flange), C (width of the body), D (width of the body), E (length of the body), F (width of the bottom flange), and a (thickness of the bottom flange).

| REF. | DIMENSIONS | | | | | |
|------|-------------|------|------|--------|-------|-------|
| | Millimeters | | | Inches | | |
| | Min. | Typ. | Max. | Min. | Typ. | Max. |
| A | | 1.35 | | | 0.053 | |
| B | | | 4.70 | | | 0.185 |
| C | | 2.54 | | | 0.100 | |
| D | 4.40 | | | 0.173 | | |
| E | 12.70 | | | 0.500 | | |
| F | | | 3.70 | | | 0.146 |
| a | | | 0.50 | | | 0.019 |

P01 Series

PACKAGE MECHANICAL DATA

SOT-223 (Plastic)

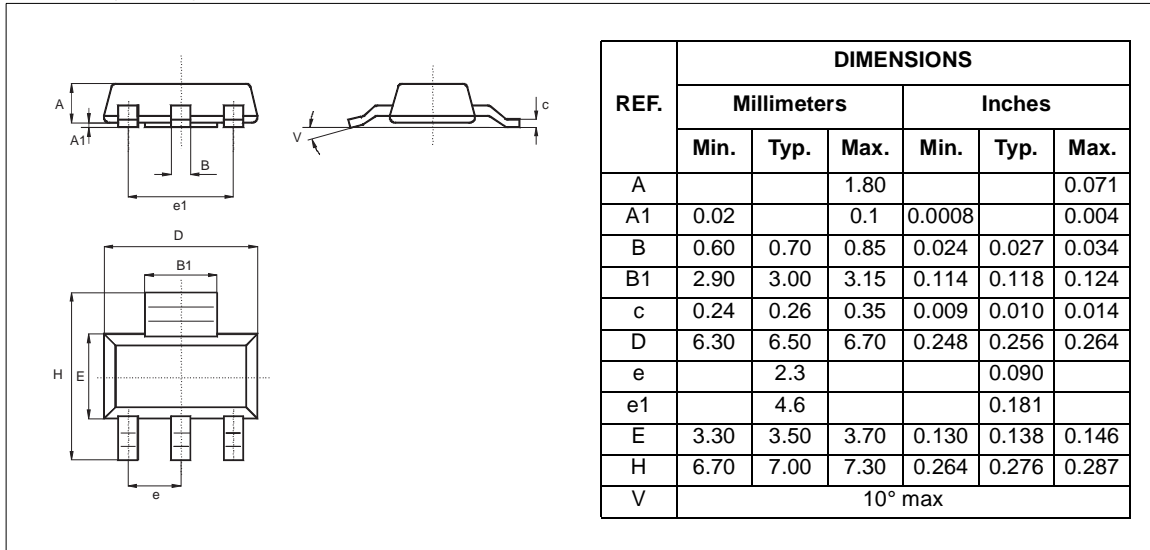

FOOTPRINT DIMENSIONS (in millimeters)

SOT-223 (Plastic)

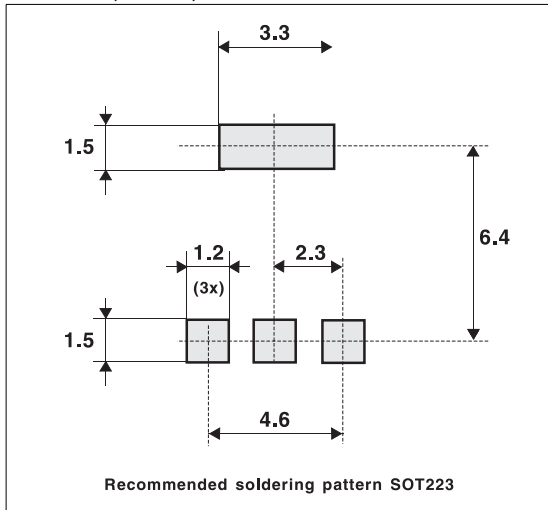

Information furnished is believed to be accurate and reliable. However, STMicroelectronics assumes no responsibility for the consequences of use of such information nor for any infringement of patents or other rights of third parties which may result from its use. No license is granted by implication or otherwise under any patent or patent rights of STMicroelectronics. Specifications mentioned in this publication are subject to change without notice. This publication supersedes and replaces all information previously supplied. STMicroelectronics products are not authorized for use as critical components in life support devices or systems without express written approval of STMicroelectronics.

© The ST logo is a registered trademark of STMicroelectronics

© 2000 STMicroelectronics - Printed in Italy - All Rights Reserved

STMicroelectronics GROUP OF COMPANIES

Australia - Brazil - China - Finland - France - Germany - Hong Kong - India - Italy - Japan - Malaysia - Malta - Morocco
Singapore - Spain - Sweden - Switzerland - United Kingdom

<http://www.st.com>