

AT-42085

Up to 6 GHz Medium Power Silicon Bipolar Transistor

Data Sheet

Description

Avago's AT-42085 is a general purpose NPN bipolar transistor that offers excellent high frequency performance. The AT-42085 is housed in a low cost .085" diameter plastic package. The 4 micron emitter-to-emitter pitch enables this transistor to be used in many different functions. The 20 emitter finger interdigitated geometry yields a medium sized transistor with impedances that are easy to match for low noise and medium power applications. Applications include use in wireless systems as an LNA, gain stage, buffer, oscillator, and mixer. An optimum noise match near 50Ω up to 1 GHz, makes this device easy to use as a low noise amplifier.

The AT-42085 bipolar transistor is fabricated using Avago's 10 GHz fT Self-Aligned-Transistor (SAT) process. The die is nitride passivated for surface protection. Excellent device uniformity, performance and reliability are produced by the use of ion-implantation, self-alignment techniques, and gold metalization in the fabrication of this device.

Features

- High Output Power:
20.5 dBm Typical P1 dB at 2.0 GHz
- High Gain at 1 dB Compression:
14.0 dB Typical G1 dB at 2.0 GHz
- Low Noise Figure:
2.0 dB Typical NFO at 2.0 GHz
- High Gain-Bandwidth Product: 8.0 GHz Typical fT
- Low Cost Plastic Package
- Lead-free Option Available

85 Plastic Package

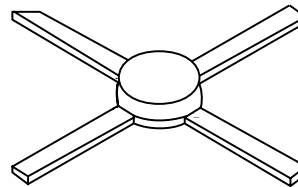

AT-42085 Absolute Maximum Ratings

Symbol	Parameter	Units	Absolute Maximum ^[1]
V _{EBO}	Emitter-Base Voltage	V	1.5
V _{CB0}	Collector-Base Voltage	V	20
V _{CE0}	Collector-Emitter Voltage	V	12
I _C	Collector Current	mA	80
P _T	Power Dissipation ^[2,3]	mW	500
T _j	Junction Temperature	°C	150
T _{STG}	Storage Temperature	°C	-65 to 150

Thermal Resistance^[2,4]:

$$\theta_{jc} = 130^{\circ}\text{C}/\text{W}$$

Notes:

1. Permanent damage may occur if any of these limits are exceeded.
2. T_{case} = 25°C.
3. Derate at 7.7 mW/°C for T_c > 85°C.
4. See MEASUREMENTS section "Thermal Resistance" for more information.

Electrical Specifications, T_A = 25°C

Symbol	Parameters and Test Conditions	Units	Min.	Typ.	Max.
S _{21E} ²	Insertion Power Gain; V _{CE} = 8 V, I _C = 35 mA	dB	15.5	17.0	
				11.0	
				5.0	
P _{1 dB}	Power Output @ 1 dB Gain Compression V _{CE} = 8 V, I _C = 35 mA	dBm		20.5	
				20.0	
G _{1 dB}	1 dB Compressed Gain; V _{CE} = 8 V, I _C = 35 mA	dB		14.0	
				9.5	
NF ₀	Optimum Noise Figure: V _{CE} = 8 V, I _C = 10 mA	dB		2.0	
				3.5	
G _A	Gain @ NF ₀ ; V _{CE} = 8 V, I _C = 10 mA	dB		13.5	
				9.5	
f _T	Gain Bandwidth Product: V _{CE} = 8 V, I _C = 35 mA	GHz		8.0	
h _{FE}	Forward Current Transfer Ratio; V _{CE} = 8 V, I _C = 35 mA	—	30	150	270
I _{CB0}	Collector Cutoff Current; V _{CB} = 8 V	μA			0.2
I _{EBO}	Emitter Cutoff Current; V _{EB} = 1 V	μA			2.0
C _{CB}	Collector Base Capacitance ^[1] : V _{CB} = 8 V, f = 1 MHz	pF		0.32	

Note:

1. For this test, the emitter is grounded.

AT-42085 Typical Performance, $T_A = 25^\circ\text{C}$

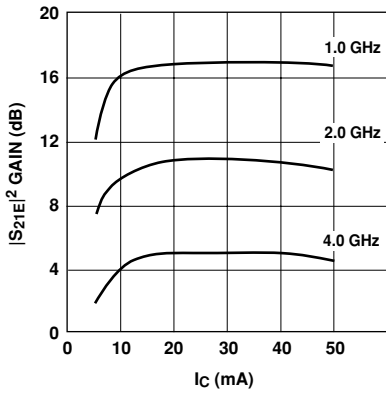

Figure 1. Insertion Power Gain vs. Collector Current and Frequency. $V_{CE} = 8\text{ V}$.

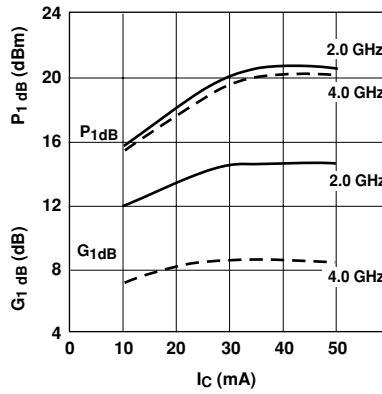

Figure 2. Output Power and 1 dB Compressed Gain vs. Collector Current and Frequency. $V_{CE} = 8\text{ V}$.

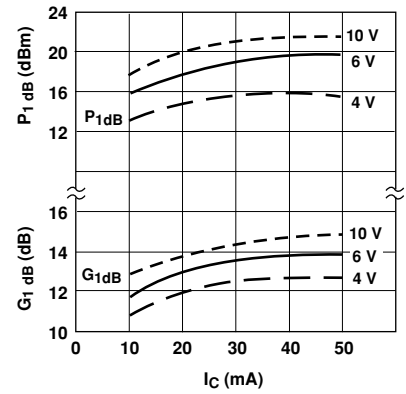

Figure 3. Output Power and 1 dB Compressed Gain vs. Collector Current and Voltage. $f = 2.0\text{ GHz}$.

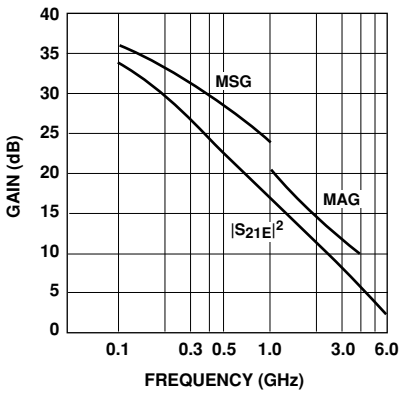

Figure 4. Insertion Power Gain, Maximum Available Gain and Maximum Stable Gain vs. Frequency. $V_{CE} = 8\text{ V}$, $I_C = 35\text{ mA}$.

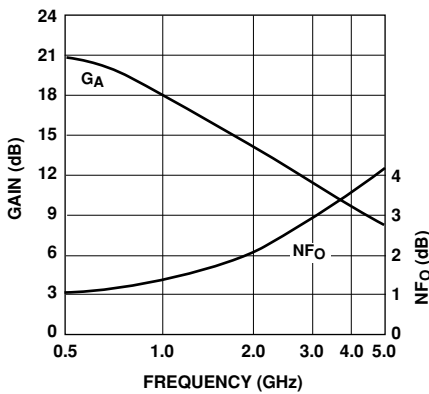

Figure 5. Noise Figure and Associated Gain vs. Frequency. $V_{CE} = 8\text{ V}$, $I_C = 10\text{ mA}$.

AT-42085 Typical Scattering Parameters,

Common Emitter, $Z_0 = 50 \Omega$, $T_A = 25^\circ\text{C}$, $V_{CE} = 8 \text{ V}$, $I_C = 10 \text{ mA}$

Freq. GHz	S_{11}			S_{21}			S_{12}		S_{22}	
	Mag.	Ang.	dB	Mag.	Ang.	dB	Mag.	Ang.	Mag.	Ang.
0.1	.72	-50	28.5	26.52	152	-37.0	.014	73	.90	-16
0.5	.66	-139	21.0	11.23	103	-29.2	.035	36	.53	-32
1.0	.65	-168	15.5	5.96	84	-28.6	.037	39	.45	-33
1.5	.65	175	12.2	4.06	71	-27.0	.045	46	.43	-36
2.0	.65	163	9.7	3.06	60	-25.3	.054	51	.42	-41
2.5	.66	157	8.0	2.51	55	-24.0	.063	60	.42	-42
3.0	.68	149	6.3	2.07	46	-22.8	.072	65	.41	-48
3.5	.68	141	5.1	1.79	38	-21.4	.085	64	.43	-55
4.0	.69	133	3.9	1.57	29	-19.7	.104	64	.45	-61
4.5	.69	125	3.0	1.41	21	-18.5	.119	63	.46	-66
5.0	.69	114	2.2	1.28	12	-17.1	.139	58	.47	-71
5.5	.71	103	1.4	1.17	3	-15.9	.161	55	.44	-76
6.0	.75	91	0.6	1.07	-6	-15.1	.177	49	.40	-85

AT-42085 Typical Scattering Parameters,

Common Emitter, $Z_0 = 50 \Omega$, $T_A = 25^\circ\text{C}$, $V_{CE} = 8 \text{ V}$, $I_C = 35 \text{ mA}$

Freq. GHz	S_{11}			S_{21}			S_{12}		S_{22}	
	Mag.	Ang.	dB	Mag.	Ang.	dB	Mag.	Ang.	Mag.	Ang.
0.1	.54	-90	33.1	45.38	137	-40.1	.010	66	.76	-26
0.5	.61	-163	22.6	13.45	95	-32.8	.023	52	.38	-30
1.0	.61	178	16.8	6.90	79	-29.5	.034	61	.34	-28
1.5	.62	167	13.4	4.67	68	-26.4	.048	68	.32	-31
2.0	.63	156	10.9	3.52	59	-23.9	.064	66	.31	-36
2.5	.64	152	9.2	2.89	54	-22.5	.075	68	.31	-40
3.0	.66	146	7.6	2.39	45	-21.2	.088	69	.30	-48
3.5	.67	139	6.3	2.07	37	-19.8	.102	67	.31	-58
4.0	.68	131	5.2	1.81	28	-18.6	.117	65	.33	-67
4.5	.68	123	4.2	1.62	19	-17.2	.138	60	.35	-73
5.0	.68	114	3.4	1.48	10	-16.4	.152	56	.35	-79
5.5	.71	103	2.5	1.34	1	-15.3	.171	50	.34	-85
6.0	.74	93	1.7	1.21	-8	-14.5	.188	46	.31	-96

A model for this device is available in the DEVICE MODELS section.

AT-42085 Noise Parameters: $V_{CE} = 8 \text{ V}$, $I_C = 10 \text{ mA}$

Freq. GHz	NF_0 dB	Γ_{opt}		$R_N/50$
		Mag	Ang	
0.1	1.1	.05	16	0.13
0.5	1.2	.06	77	0.13
1.0	1.3	.10	131	0.12
2.0	2.0	.24	-179	0.11
4.0	3.5	.46	-128	0.25

Ordering Information

Part Numbers	No. of Devices
AT-42085	10
AT-42085G	100

Note: Order part number with a "G" suffix if lead-free option is desired.

85 Plastic Package Dimensions

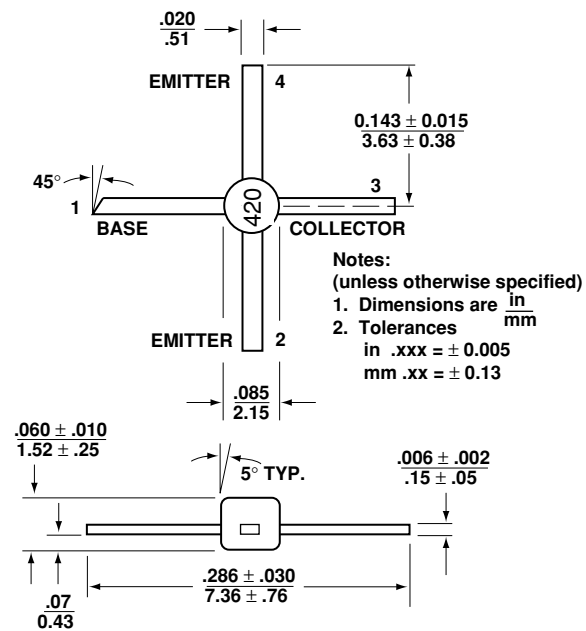

For product information and a complete list of distributors, please go to our web site: www.avagotech.com

Avago, Avago Technologies, and the A logo are trademarks of Avago Technologies, Limited in the United States and other countries. Data subject to change. Copyright © 2008 Avago Technologies, Limited. All rights reserved. Obsoletes 5989-2655EN AV02-1219EN May 5, 2008

Avago
TECHNOLOGIES