



# PHOTOCOUPLER PS2865-1

## HIGH ISOLATION VOLTAGE AC INPUT RESPONSE TYPE 4-PIN SOP PHOTOCOUPLER

–NEPOC Series–

### DESCRIPTION

The PS2865-1 is an optically coupled isolator containing GaAs light emitting diodes and an NPN silicon phototransistor.

The PS2865-1 meets insulation thickness 0.4 mm and BSI's insulation supplementary approved.

The package has shield effect to cut off ambient light, and is mounted in a plastic SOP (Small Outline Package) for high density applications.

### FEATURES

- Isolation distance (0.4 mm MIN.)
- AC input response
- High isolation voltage ( $BV = 2\,500\text{ V r.m.s.}$ )
- SOP (Small Outline Package) type
- High-speed switching ( $t_r = 4\ \mu\text{s TYP.}$ ,  $t_f = 5\ \mu\text{s TYP.}$ )
- Ordering number of tape product: PS2865-1-F3, F4
- Safety standards: PS2865-1
  - UL approved: File No. E72422 (S)
  - BSI approved: No. 8514, 8515

### APPLICATIONS

- Modem
- Programmable logic controllers
- Power supply

The information in this document is subject to change without notice. Before using this document, please confirm that this is the latest version.

★ PACKAGE DIMENSIONS (UNIT: mm)

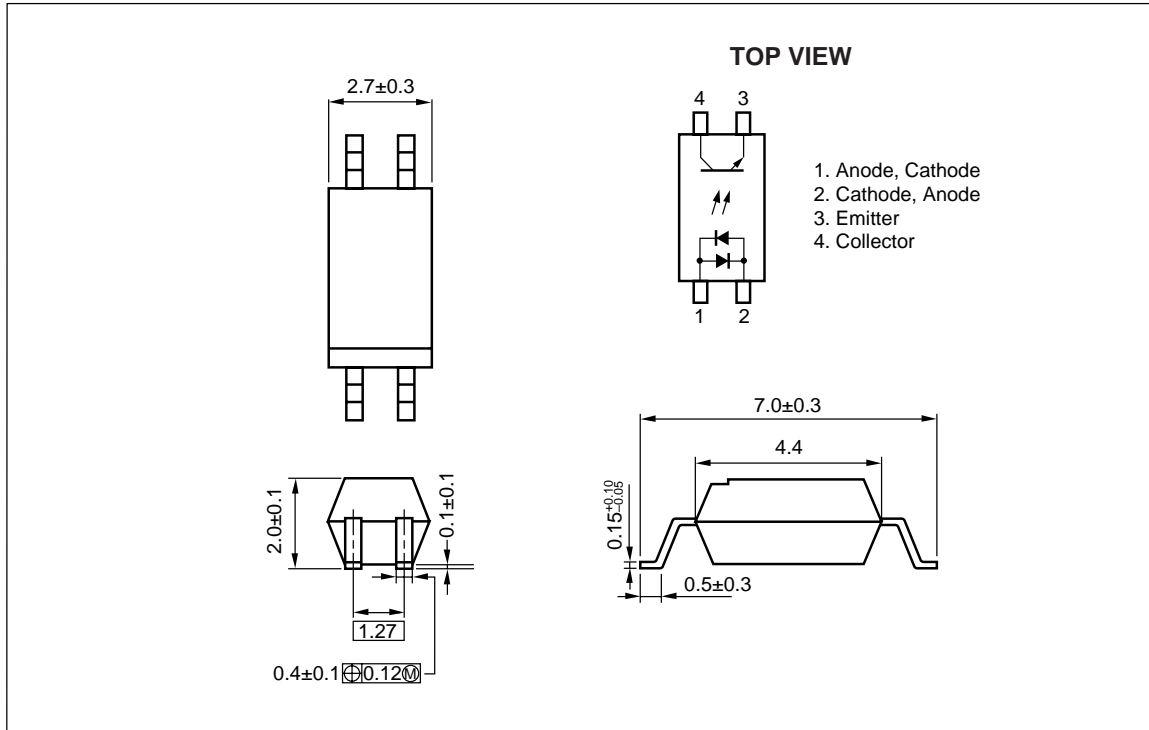

PHOTOCOUPLER CONSTRUCTION

Parameter	Unit (MIN.)
Air Distance	4.5 mm
Creepage Distance	4.5 mm
Isolation Distance	0.4 mm

MARKING

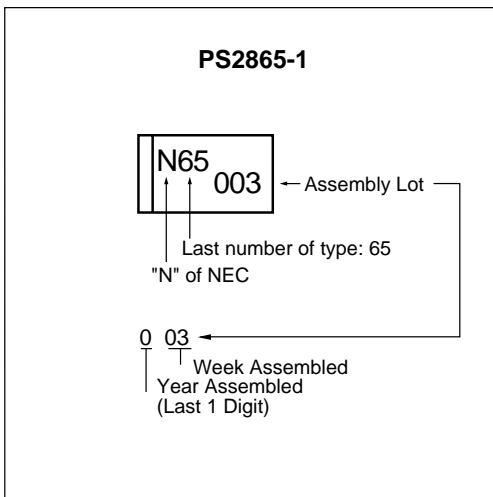

**ORDERING INFORMATION (Solder Contains Lead)**

Part Number	Package	Packing Style	Application Part Number <sup>*1</sup>
★ PS2865-1	4-pin SOP	50 pcs (Tape 50 pcs cut)	PS2865-1
PS2865-1-F3		Embossed Tape 3 500 pcs/reel	
PS2865-1-F4			

\*1 For the application of the Safety Standard, following part number should be used.

**ORDERING INFORMATION (Pb-Free)**

Part Number	Package	Packing Style	Application Part Number <sup>*1</sup>
★ PS2865-1-A	4-pin SOP	50 pcs (Tape 50 pcs cut)	PS2865-1
PS2865-1-F3-A		Embossed Tape 3 500 pcs/reel	
PS2865-1-F4-A			

\*1 For the application of the Safety Standard, following part number should be used.

**ABSOLUTE MAXIMUM RATINGS (T<sub>A</sub> = 25 °C, unless otherwise specified)**

Parameter		Symbol	Ratings	Unit
Diode	Forward Current (DC)	I <sub>F</sub>	± 50	mA
	Power Dissipation	P <sub>D</sub>	60	mW
	Peak Forward Current <sup>*1</sup>	I <sub>FP</sub>	± 1.0	A
Transistor	Collector to Emitter Voltage	V <sub>CEO</sub>	40	V
	Emitter to Collector Voltage	V <sub>ECO</sub>	5	V
	Collector Current	I <sub>C</sub>	40	mA
	Power Dissipation Derating	ΔP <sub>C</sub> /°C	1.2	mW/°C
	Power Dissipation	P <sub>C</sub>	120	mW
Isolation Voltage <sup>*2</sup>		BV	2 500	Vr.m.s.
Operating Ambient Temperature		T <sub>A</sub>	-55 to +100	°C
Storage Temperature		T <sub>stg</sub>	-55 to +150	°C

\*1 PW = 100 μs, Duty Cycle = 1 %

\*2 AC voltage for 1 minute at T<sub>A</sub> = 25 °C, RH = 60 % between input and output

**ELECTRICAL CHARACTERISTICS (T<sub>A</sub> = 25 °C)**

Parameter		Symbol	Conditions	MIN.	TYP.	MAX.	Unit
Diode	Forward Voltage	V <sub>F</sub>	I <sub>F</sub> = ± 5 mA		1.1	1.4	V
	Terminal Capacitance	C <sub>i</sub>	V = 0 V, f = 1 MHz		30		pF
Transistor	Collector to Emitter Dark Current	I <sub>CEO</sub>	I <sub>F</sub> = 0 mA, V <sub>CE</sub> = 40 V			100	nA
Coupled	Current Transfer Ratio (I <sub>C</sub> /I <sub>F</sub> ) *1	CTR	I <sub>F</sub> = ± 5 mA, V <sub>CE</sub> = 5 V	50	200	400	%
	Collector Saturation Voltage	V <sub>CE(sat)</sub>	I <sub>F</sub> = ± 10 mA, I <sub>C</sub> = 2 mA			0.3	V
	Isolation Resistance	R <sub>I-O</sub>	V <sub>I-O</sub> = 1 kV <sub>DC</sub>	10 <sup>11</sup>			Ω
	Isolation Capacitance	C <sub>I-O</sub>	V = 0 V, f = 1 MHz		0.4		pF
	Rise Time*2	t <sub>r</sub>	V <sub>CC</sub> = 5 V, I <sub>C</sub> = 2 mA, R <sub>L</sub> = 100 Ω		4		μs
	Fall Time*2	t <sub>f</sub>			5		

\*1 CTR rank

N: 50 to 400 (%)

\*2 Test circuit for switching time

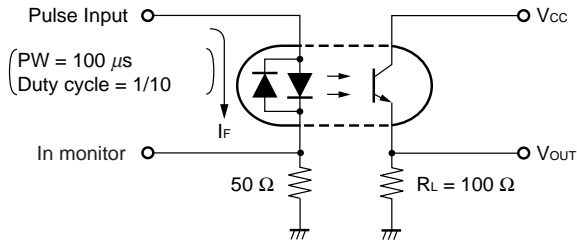

**TYPICAL CHARACTERISTICS ( $T_A = 25\text{ }^\circ\text{C}$ , unless otherwise specified)**

**DIODE POWER DISSIPATION vs. AMBIENT TEMPERATURE**

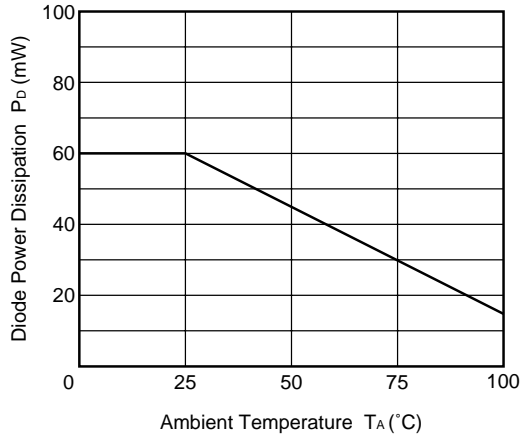

**TRANSISTOR POWER DISSIPATION vs. AMBIENT TEMPERATURE**

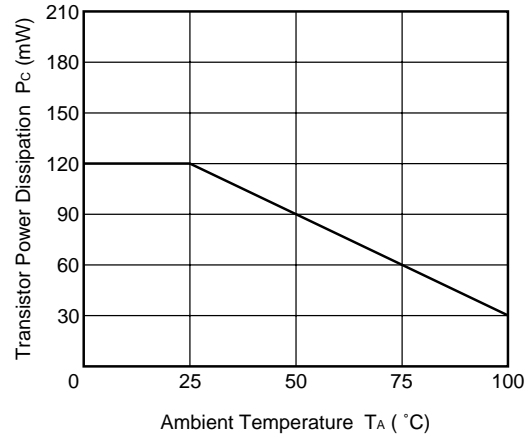

**FORWARD CURRENT vs. FORWARD VOLTAGE**

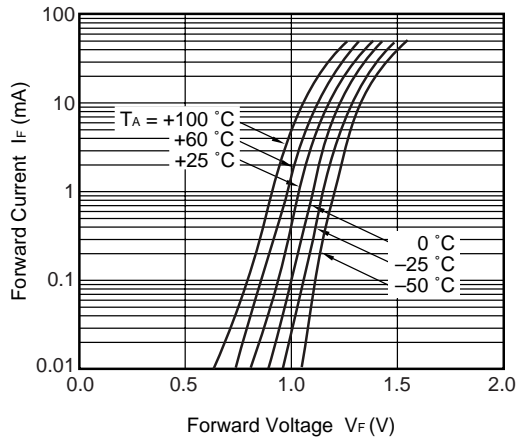

**COLLECTOR CURRENT vs. COLLECTOR TO EMITTER VOLTAGE**

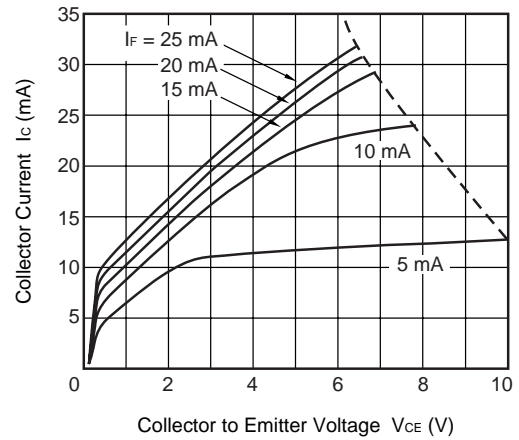

**COLLECTOR TO EMITTER DARK CURRENT vs. AMBIENT TEMPERATURE**

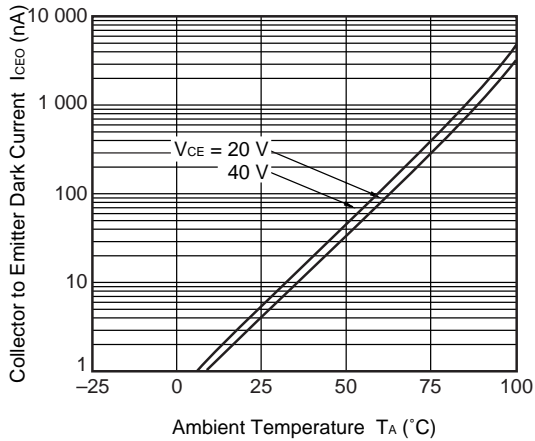

**COLLECTOR CURRENT vs. COLLECTOR SATURATION VOLTAGE**

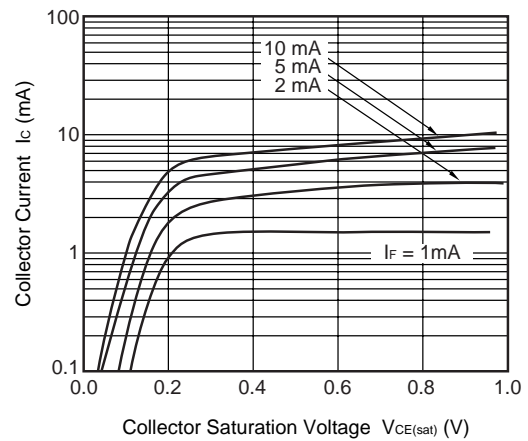

NORMALIZED CURRENT TRANSFER RATIO vs. AMBIENT TEMPERATURE

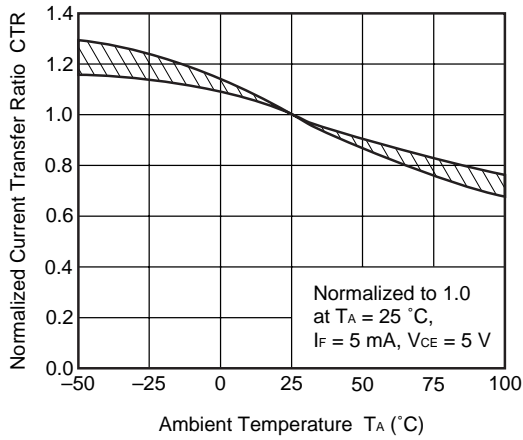

CURRENT TRANSFER RATIO vs. FORWARD CURRENT

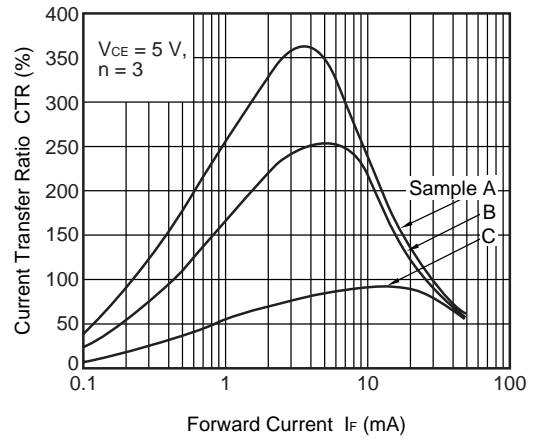

SWITCHING TIME vs. LOAD RESISTANCE

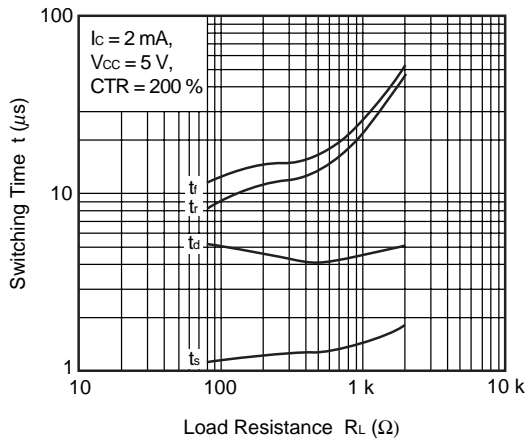

SWITCHING TIME vs. LOAD RESISTANCE

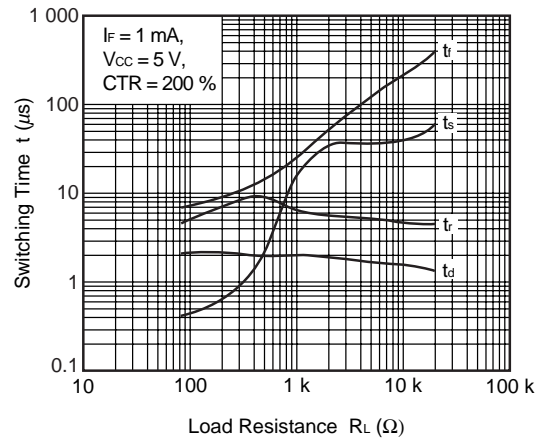

FREQUENCY RESPONSE

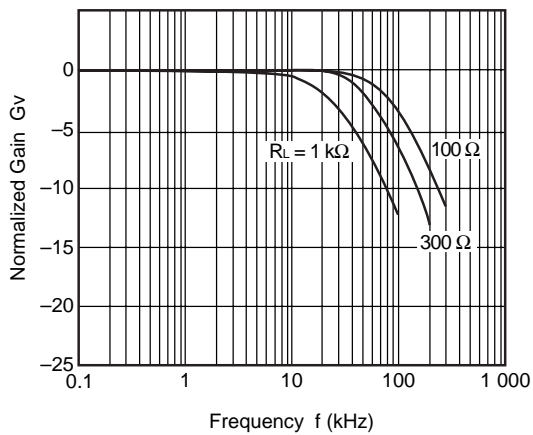

LONG TERM CTR DEGRADATION

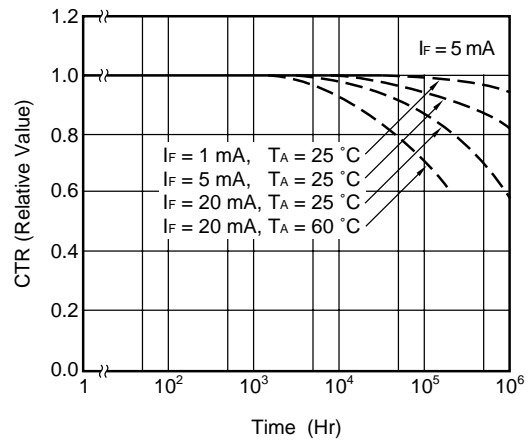

**Remark** The graphs indicate nominal characteristics.

★ TAPING SPECIFICATIONS (UNIT: mm)

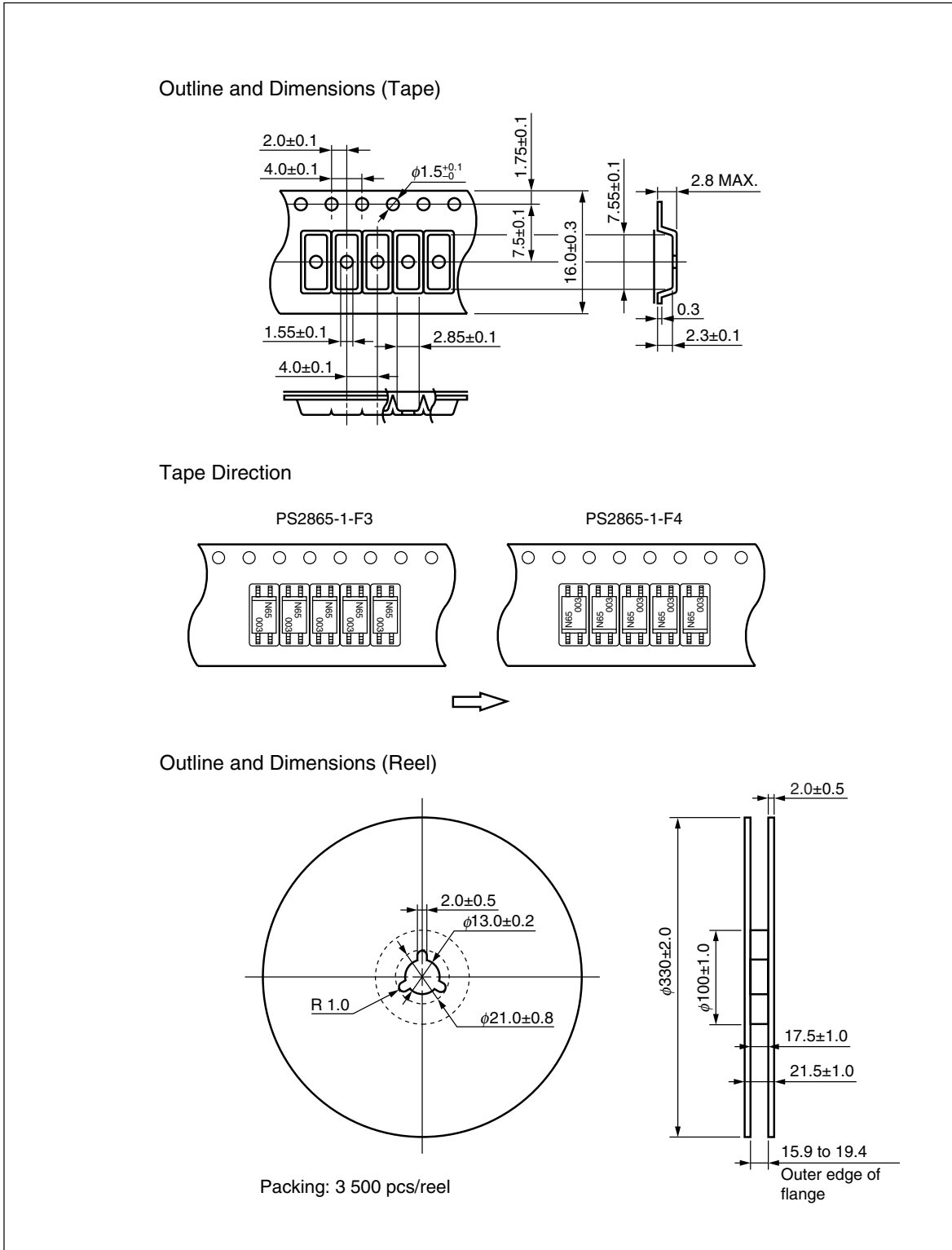

## NOTES ON HANDLING

### 1. Recommended soldering conditions

#### (1) Infrared reflow soldering

- Peak reflow temperature 235 °C or below (package surface temperature)
- Time of temperature higher than 210 °C 30 seconds or less
- Number of reflows Three
- Flux Rosin flux containing small amount of chlorine (The flux with a maximum chlorine content of 0.2 Wt % is recommended.)

Recommended Temperature Profile of Infrared Reflow

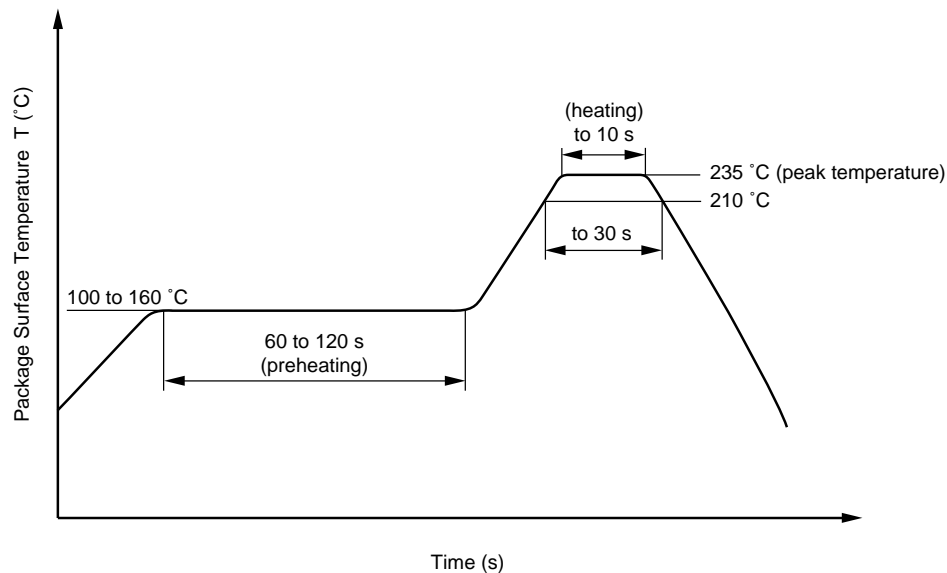

#### (2) Dip soldering

- Temperature 260 °C or below (molten solder temperature)
- Time 10 seconds or less
- Number of times One (Allowed to be dipped in solder including plastic mold portion.)
- Flux Rosin flux containing small amount of chlorine (The flux with a maximum chlorine content of 0.2 Wt % is recommended.)

#### (3) Cautions

- Fluxes  
Avoid removing the residual flux with freon-based and chlorine-based cleaning solvent.

## 2. Cautions regarding noise

Be aware that when voltage is applied suddenly between the photocoupler's input and output or between corrector-emitters at startup, the output side may enter the on state, even if the voltage is within the absolute maximum ratings.



Subject: Compliance with EU Directives

CEL certifies, to its knowledge, that semiconductor and laser products detailed below are compliant with the requirements of European Union (EU) Directive 2002/95/EC Restriction on Use of Hazardous Substances in electrical and electronic equipment (RoHS) and the requirements of EU Directive 2003/11/EC Restriction on Penta and Octa BDE.

CEL Pb-free products have the same base part number with a suffix added. The suffix –A indicates that the device is Pb-free. The –AZ suffix is used to designate devices containing Pb which are exempted from the requirement of RoHS directive (\*). In all cases the devices have Pb-free terminals. All devices with these suffixes meet the requirements of the RoHS directive.

This status is based on CEL’s understanding of the EU Directives and knowledge of the materials that go into its products as of the date of disclosure of this information.

Restricted Substance per RoHS	Concentration Limit per RoHS (values are not yet fixed)	Concentration contained in CEL devices	
		-A	-AZ
Lead (Pb)	< 1000 PPM	Not Detected	(*)
Mercury	< 1000 PPM	Not Detected	
Cadmium	< 100 PPM	Not Detected	
Hexavalent Chromium	< 1000 PPM	Not Detected	
PBB	< 1000 PPM	Not Detected	
PBDE	< 1000 PPM	Not Detected	

If you should have any additional questions regarding our devices and compliance to environmental standards, please do not hesitate to contact your local representative.

**Important Information and Disclaimer:** Information provided by CEL on its website or in other communications concerning the substance content of its products represents knowledge and belief as of the date that it is provided. CEL bases its knowledge and belief on information provided by third parties and makes no representation or warranty as to the accuracy of such information. Efforts are underway to better integrate information from third parties. CEL has taken and continues to take reasonable steps to provide representative and accurate information but may not have conducted destructive testing or chemical analysis on incoming materials and chemicals. CEL and CEL suppliers consider certain information to be proprietary, and thus CAS numbers and other limited information may not be available for release.

In no event shall CEL’s liability arising out of such information exceed the total purchase price of the CEL part(s) at issue sold by CEL to customer on an annual basis.

See CEL Terms and Conditions for additional clarification of warranties and liability.