

10-line IPAD™, EMI filter and ESD protection for LCD and cameras

Features

- Lead-free package
- EMI symmetrical (I/O) low-pass filter
- High efficiency in EMI filtering
- 400 µm pitch
- Compatible with high speed data rate
- Very low PCB space occupation: < 4mm²
- Very thin package: 0.60 mm
- High efficiency in ESD suppression
- High reliability offered by monolithic integration
- High reduction of parasitic elements through integration and wafer level packaging

Complies with the following standards

- IEC61000-4-2 level 4 on inputs and outputs
 - 15 kV (air discharge)
 - 8 kV (contact discharge)
- MIL STD 883E - Method 3015-6 Class 3

Applications

Where EMI filtering in ESD sensitive equipment is required :

- LCD for mobile phones
- Computers and printers
- Communication systems
- MCU boards

Description

The EMIF10-LCD02F3 is a 10-line highly integrated device designed to suppress EMI/RFI noise in all systems subjected to electromagnetic interference. The EMIF10 Flip Chip packaging means the package size is equal to the die size.

This filter includes ESD protection circuitry, which prevents damage to the protected device when subjected to ESD surges up to 15kV.

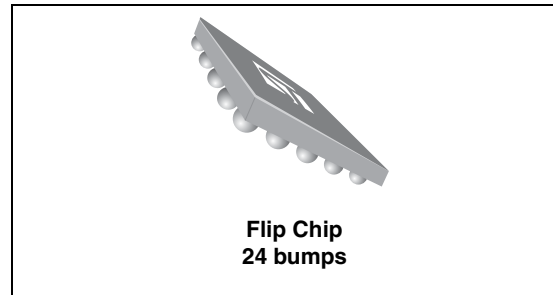


Figure 1. Pin layout (bump side)

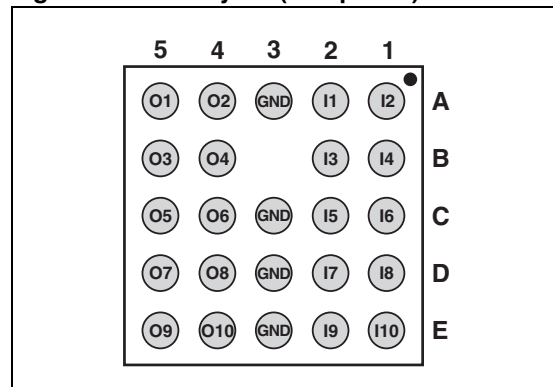
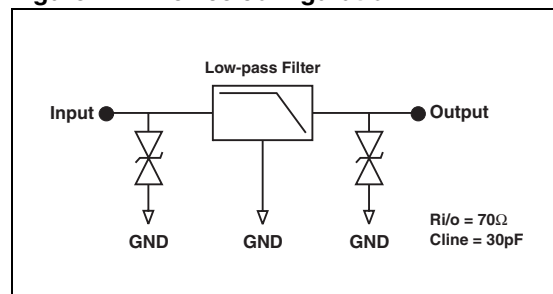


Figure 2. Device configuration



TM: IPAD is a trademark of STMicroelectronics.

1 Characteristics

Table 1. Absolute maximum ratings ($T_{amb} = 25\text{ }^{\circ}\text{C}$)

Symbol	Parameter and test conditions	Value	Unit
T_j	Maximum junction temperature	125	$^{\circ}\text{C}$
T_{op}	Operating temperature range	-40 to +85	$^{\circ}\text{C}$
T_{stg}	Storage temperature range	-55 to 150	$^{\circ}\text{C}$

Table 2. Electrical characteristics ($T_{amb} = 25\text{ }^{\circ}\text{C}$)

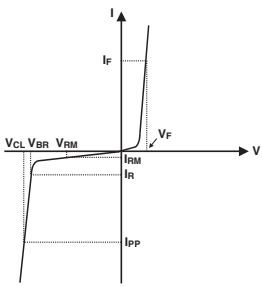
Symbol	Parameters				
V_{BR}	Breakdown voltage				
I_{RM}	Leakage current @ V_{RM}				
V_{RM}	Stand-off voltage				
V_{CL}	Clamping voltage				
I_{PP}	Peak pulse current				
$R_{I/O}$	Series resistance between Input & Output				
C_{line}	Input capacitance per line				
Symbol	Test conditions	Min	Typ	Max	Unit
V_{BR}	$I_R = 1\text{ mA}$	6	8	10	V
I_{RM}	$V_{RM} = 3\text{ V}$		50	200	nA
R_2	Tolerance $\pm 20\%$		70		Ω
C_{line}	$V_{line} = 0\text{ V}$, $V_{OSC} = 30\text{ mV}$, $F = 1\text{ MHz}$			30	pF

Figure 3. S21(dB) all lines attenuation measurement and APlac simulation

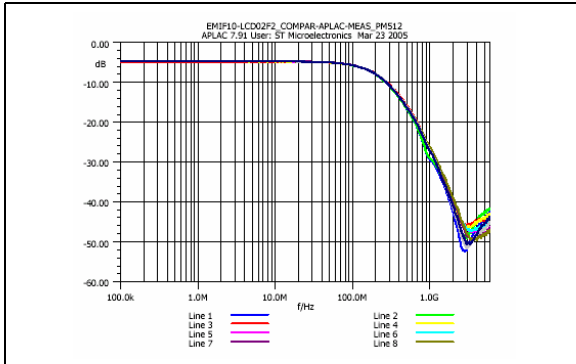


Figure 4. Analog cross talk measurement

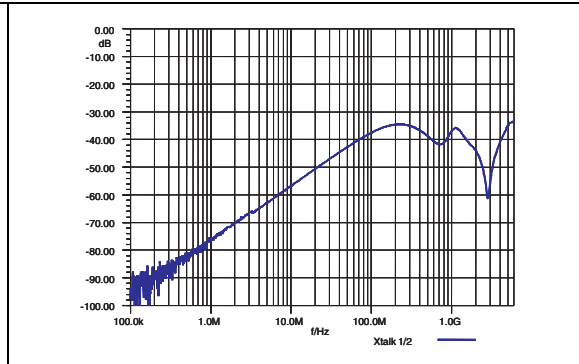


Figure 5. ESD response to IEC 61000-4-2 (+15 kV air discharge) on one input and on one output

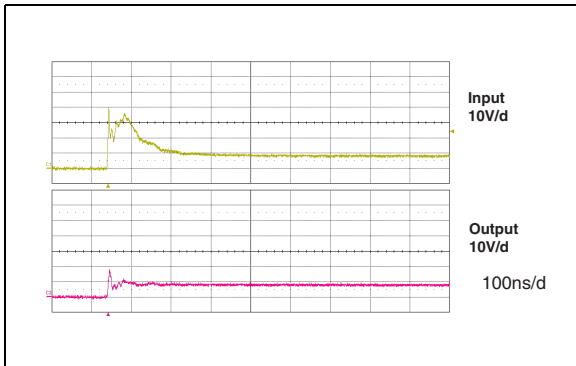


Figure 6. ESD response to IEC 61000-4-2 (-15 kV air discharge) on one input and on one output

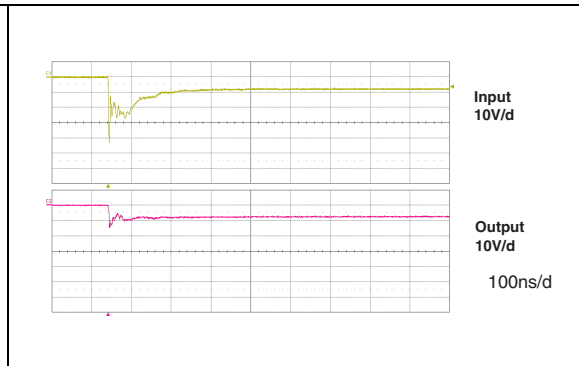
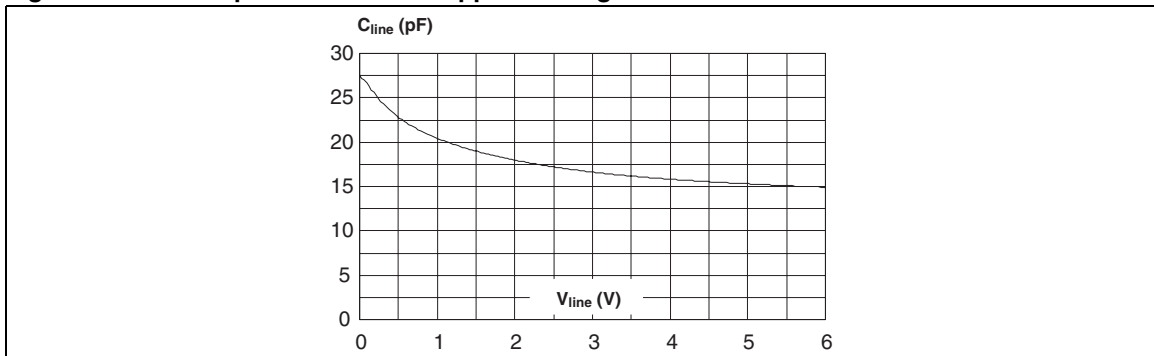


Figure 7. Line capacitance versus applied voltage



2 Application information

Figure 8. Device structure (one cell)

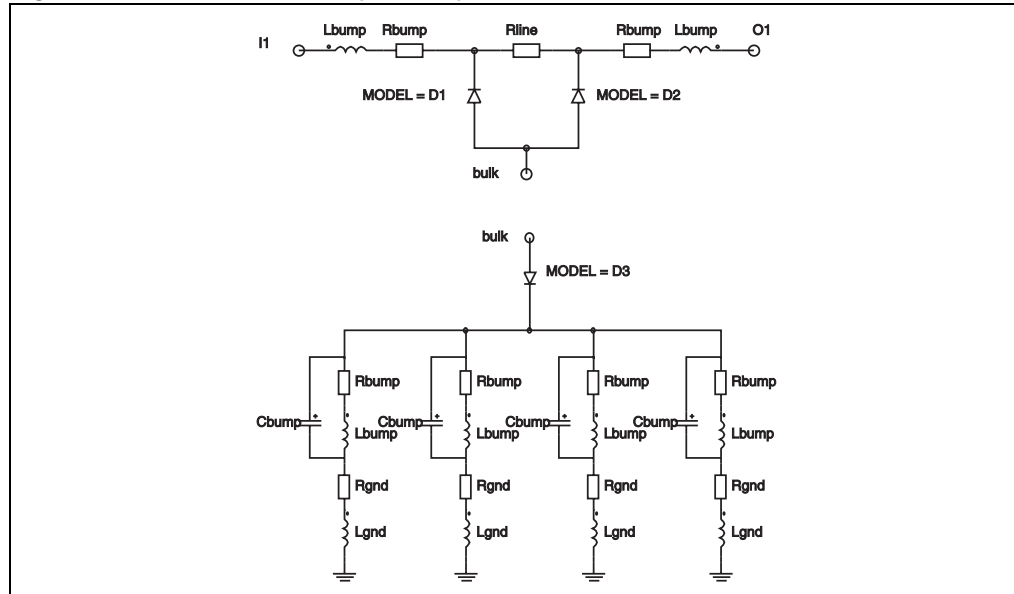
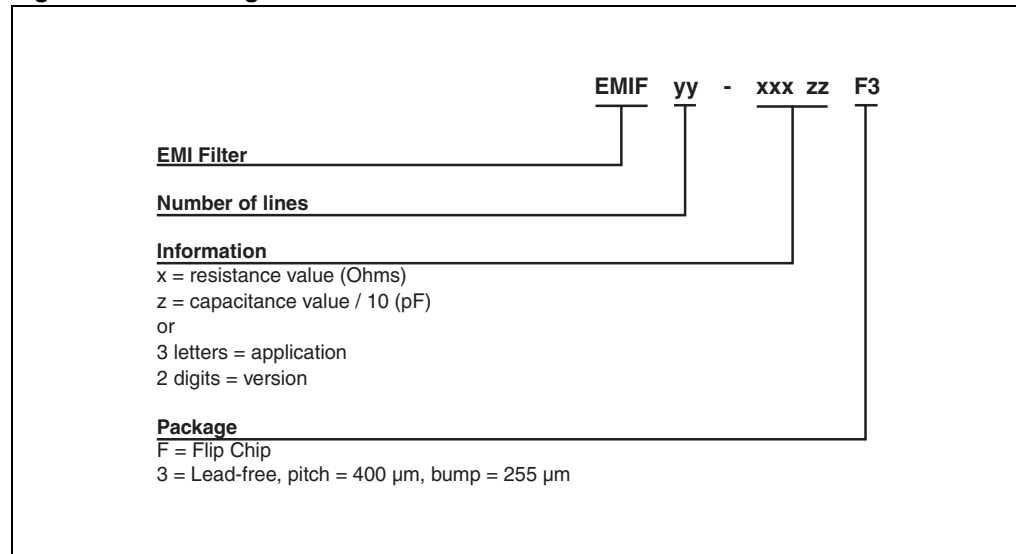


Figure 9. APlac model variables

aplacvar Rline 70			
aplacvar C_d1 15p			
aplacvar C_d2 15p			
aplacvar C_d3 600p			
aplacvar Ls 950pH	Diode D1	Diode D2	Diode D3
aplacvar Rs 150m	BV=7	BV=7	BV=7
aplacvar Lbump 50pH	IBV=1m	IBV=1m	IBV=1m
aplacvar Rbump 20m	CJO=C_d1	CJO=C_d2	CJO=C_d3
aplacvar Cbump 150f	M=0.28	M=0.28	M=0.28
aplacvar Lgnd 50pH	RS=0.1	RS=0.1	RS=0.01
aplacvar Rgnd 100m	VJ=0.6	VJ=0.6	VJ=0.6
aplacvar Rsub 10m	TT=100n	TT=100n	TT=100n

3 Ordering information scheme

Figure 10. Ordering information scheme



4 Package information

In order to meet environmental requirements, ST offers these devices in ECOPACK[®] packages. These packages have a lead-free second level interconnect. The category of second level interconnect is marked on the inner box label, in compliance with JEDEC Standard JESD97. The maximum ratings related to soldering conditions are also marked on the inner box label. ECOPACK is an ST trademark. ECOPACK specifications are available at www.st.com.

Figure 11. Package dimensions

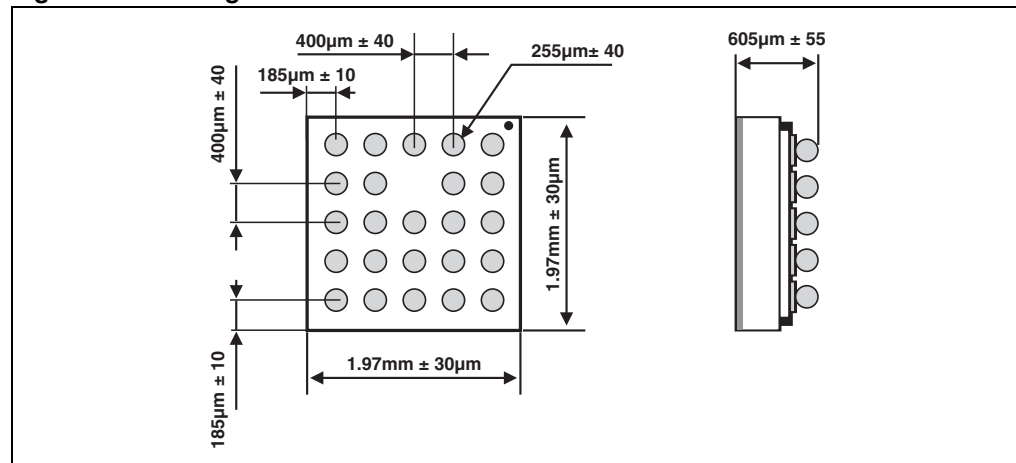


Figure 12. Footprint

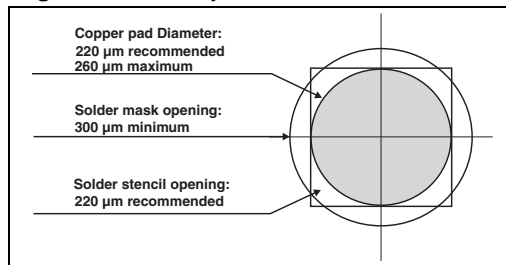


Figure 13. Marking

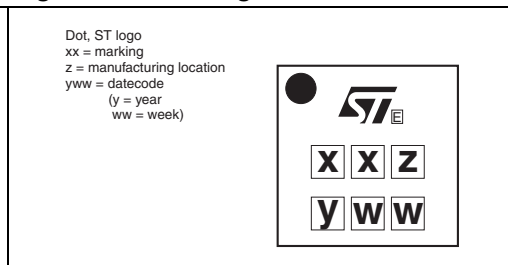
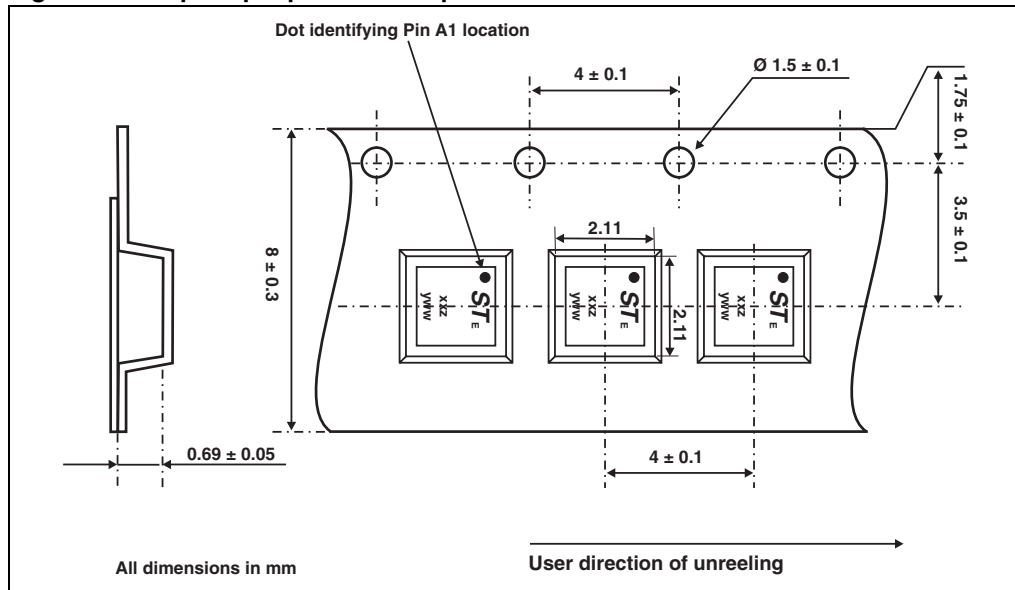


Figure 14. Flip Chip tape and reel specification



Note:

More information is available in the application notes:

N2348: "STMicroelectronics 400 micro-metre Flip Chip: Package description and recommendation for use"

AN1751: "EMI Filters: Recommendations and measurements"

5 Ordering information

Table 3. Ordering information

Order code	Marking	Package	Weight	Base qty	Delivery mode
EMIF10-LCD02F3	GY	Flip Chip	5.0 mg	5000	Tape and reel 7"

6 Revision history

Table 4. Document revision history

Date	Revision	Changes
11-Jul-2005	1	First issue.
28-Apr-2008	2	Updated ECOPACK statement. Updated Figure 10 , Figure 11 , Figure 12 and Figure 14 . Reformatted to current standards.

Please Read Carefully:

Information in this document is provided solely in connection with ST products. STMicroelectronics NV and its subsidiaries ("ST") reserve the right to make changes, corrections, modifications or improvements, to this document, and the products and services described herein at any time, without notice.

All ST products are sold pursuant to ST's terms and conditions of sale.

Purchasers are solely responsible for the choice, selection and use of the ST products and services described herein, and ST assumes no liability whatsoever relating to the choice, selection or use of the ST products and services described herein.

No license, express or implied, by estoppel or otherwise, to any intellectual property rights is granted under this document. If any part of this document refers to any third party products or services it shall not be deemed a license grant by ST for the use of such third party products or services, or any intellectual property contained therein or considered as a warranty covering the use in any manner whatsoever of such third party products or services or any intellectual property contained therein.

UNLESS OTHERWISE SET FORTH IN ST'S TERMS AND CONDITIONS OF SALE ST DISCLAIMS ANY EXPRESS OR IMPLIED WARRANTY WITH RESPECT TO THE USE AND/OR SALE OF ST PRODUCTS INCLUDING WITHOUT LIMITATION IMPLIED WARRANTIES OF MERCHANTABILITY, FITNESS FOR A PARTICULAR PURPOSE (AND THEIR EQUIVALENTS UNDER THE LAWS OF ANY JURISDICTION), OR INFRINGEMENT OF ANY PATENT, COPYRIGHT OR OTHER INTELLECTUAL PROPERTY RIGHT.

UNLESS EXPRESSLY APPROVED IN WRITING BY AN AUTHORIZED ST REPRESENTATIVE, ST PRODUCTS ARE NOT RECOMMENDED, AUTHORIZED OR WARRANTED FOR USE IN MILITARY, AIR CRAFT, SPACE, LIFE SAVING, OR LIFE SUSTAINING APPLICATIONS, NOR IN PRODUCTS OR SYSTEMS WHERE FAILURE OR MALFUNCTION MAY RESULT IN PERSONAL INJURY, DEATH, OR SEVERE PROPERTY OR ENVIRONMENTAL DAMAGE. ST PRODUCTS WHICH ARE NOT SPECIFIED AS "AUTOMOTIVE GRADE" MAY ONLY BE USED IN AUTOMOTIVE APPLICATIONS AT USER'S OWN RISK.

Resale of ST products with provisions different from the statements and/or technical features set forth in this document shall immediately void any warranty granted by ST for the ST product or service described herein and shall not create or extend in any manner whatsoever, any liability of ST.

ST and the ST logo are trademarks or registered trademarks of ST in various countries.

Information in this document supersedes and replaces all information previously supplied.

The ST logo is a registered trademark of STMicroelectronics. All other names are the property of their respective owners.

© 2008 STMicroelectronics - All rights reserved

STMicroelectronics group of companies

Australia - Belgium - Brazil - Canada - China - Czech Republic - Finland - France - Germany - Hong Kong - India - Israel - Italy - Japan - Malaysia - Malta - Morocco - Singapore - Spain - Sweden - Switzerland - United Kingdom - United States of America

www.st.com