

# LM6181

## 100 mA, 100 MHz Current Feedback Amplifier

### General Description

The LM6181 current-feedback amplifier offers an unparalleled combination of bandwidth, slew-rate, and output current. The amplifier can directly drive up to 100 pF capacitive loads without oscillating and a 10V signal into a 50Ω or 75Ω back-terminated coax cable system over the full industrial temperature range. This represents a radical enhancement in output drive capability for an 8-pin DIP high-speed amplifier making it ideal for video applications.

Built on National's advanced high-speed VIP™ II (Vertically Integrated PNP) process, the LM6181 employs current-feedback providing bandwidth that does not vary dramatically with gain; 100 MHz at  $A_v = -1$ , 60 MHz at  $A_v = -10$ . With a slew rate of 2000V/μs, 2nd harmonic distortion of -50 dBc at 10 MHz and settling time of 50 ns (0.1%) the LM6181 dynamic performance makes it ideal for data acquisition, high speed ATE, and precision pulse amplifier applications.

### Features

(Typical unless otherwise noted)

- Slew rate: 2000 V/μs
- Settling time (0.1%): 50 ns
- Characterized for supply ranges: ±5V and ±15V
- Low differential gain and phase error: 0.05%, 0.04°
- High output drive: ±10V into 100Ω
- Guaranteed bandwidth and slew rate
- Improved performance over EL2020, OP160, AD844, LT1223 and HA5004

### Applications

- Coax cable driver
- Video amplifier
- Flash ADC buffer
- High frequency filter
- Scanner and Imaging systems

### Typical Application

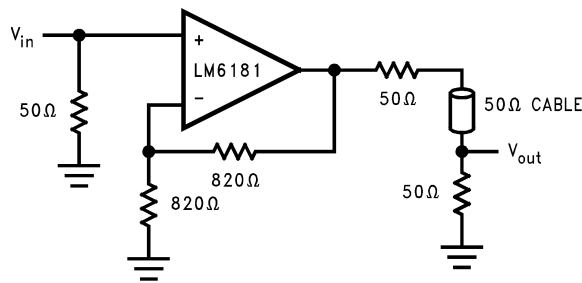

Cable Driver

01132801

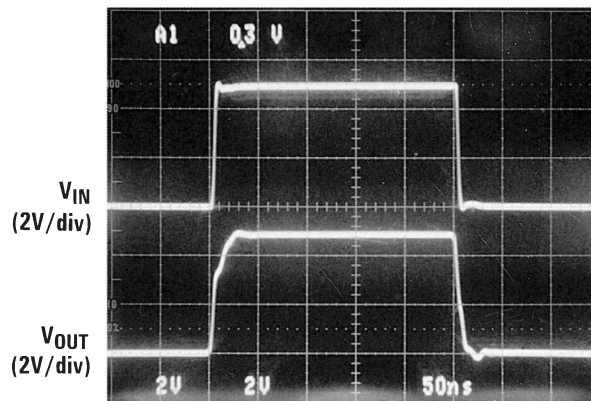

TIME (50ns/div)

01132802

VIP™ is a registered trademark of National Semiconductor Corporation.

**Absolute Maximum Ratings** (Note 1)

If Military/Aerospace specified devices are required, please contact the National Semiconductor Sales Office/Distributors for availability and specifications.

Supply Voltage	±18V
Differential Input Voltage	±6V
Input Voltage	±Supply Voltage
Inverting Input Current	15 mA
Soldering Information	
Dual-In-Line Package (N)	
Soldering (10 sec)	260°C
Small Outline Package (M)	
Vapor Phase (60 seconds)	215°C
Infrared (15 seconds)	220°C
Output Short Circuit	(Note 7)

Storage Temperature Range	$-65^{\circ}\text{C} \leq T_J \leq +150^{\circ}\text{C}$
Maximum Junction Temperature	150°C
ESD Rating (Note 2)	±3000V

**Operating Ratings**

Supply Voltage Range	7V to 32V
Junction Temperature Range (Note 3)	
LM6181AM	$-55^{\circ}\text{C} \leq T_J \leq +125^{\circ}\text{C}$
LM6181AI, LM6181I	$-40^{\circ}\text{C} \leq T_J \leq +85^{\circ}\text{C}$
Thermal Resistance ( $\theta_{JA}$ , $\theta_{JC}$ )	
8-pin DIP (N)	102°C/W, 42°C/W
8-pin SO (M-8)	153°C/W, 42°C/W
16-pin SO (M)	70°C/W, 38°C/W

**±15V DC Electrical Characteristics**

The following specifications apply for Supply Voltage = ±15V,  $R_F = 820\Omega$ , and  $R_L = 1\text{ k}\Omega$  unless otherwise noted. **Boldface** limits apply at the temperature extremes; all other limits  $T_J = 25^{\circ}\text{C}$ .

Symbol	Parameter	Conditions	LM6181AM		LM6181AI		LM6181I		Units
			Typical (Note 4)	Limit (Note 5)	Typical (Note 4)	Limit (Note 5)	Typical (Note 4)	Limit (Note 5)	
$V_{OS}$	Input Offset Voltage		2.0	3.0 <b>4.0</b>	2.0	3.0 <b>3.5</b>	3.5	5.0 <b>5.5</b>	mV max
$TC_{V_{OS}}$	Input Offset Voltage Drift		5.0		5.0		5.0		$\mu\text{V}/^{\circ}\text{C}$
$I_B$	Inverting Input Bias Current		2.0	5.0 <b>12.0</b>	2.0	5.0 <b>12.0</b>	5.0	10 <b>17.0</b>	$\mu\text{A}$ max
	Non-Inverting Input Bias Current		0.5	1.5 <b>3.0</b>	0.5	1.5 <b>3.0</b>	2.0	3.0 <b>5.0</b>	
$TC_{I_B}$	Inverting Input Bias Current Drift		30		30		30		$\text{nA}/^{\circ}\text{C}$
	Non-Inverting Input Bias Current Drift		10		10		10		
$I_B$ PSR	Inverting Input Bias Current	$V_S = \pm 4.5\text{V}, \pm 16\text{V}$	0.3	0.5	0.3	0.5	0.3	0.75	$\mu\text{A}/\text{V}$
	Power Supply Rejection			<b>3.0</b>		<b>3.0</b>		<b>4.5</b>	max
	Non-Inverting Input Bias Current	$V_S = \pm 4.5\text{V}, \pm 16\text{V}$	0.05	0.5	0.05	0.5	0.05	0.5	
$I_B$ CMR	Power Supply Rejection			<b>1.5</b>		<b>1.5</b>		<b>3.0</b>	
	Inverting Input Bias Current	$-10\text{V} \leq V_{CM} \leq +10\text{V}$	0.3	0.5	0.3	0.5	0.3	0.75	
	Common Mode Rejection			<b>0.75</b>		<b>0.75</b>		<b>1.0</b>	
$I_B$	Non-Inverting Input Bias Current	$-10\text{V} \leq V_{CM} \leq +10\text{V}$	0.1	0.5	0.1	0.5	0.1	0.5	
	Common Mode Rejection			<b>0.5</b>		<b>0.5</b>		<b>0.5</b>	
CMRR	Common Mode Rejection Ratio	$-10\text{V} \leq V_{CM} \leq +10\text{V}$	60	50	60	50	60	50	dB
				<b>50</b>		<b>50</b>		<b>50</b>	min
PSRR	Power Supply Rejection Ratio	$V_S = \pm 4.5\text{V}, \pm 16\text{V}$	80	70	80	70	80	70	dB
				<b>70</b>		<b>70</b>		<b>65</b>	min
$R_O$	Output Resistance	$A_V = -1, f = 300\text{ kHz}$	0.2		0.2		0.2		$\Omega$

**±15V DC Electrical Characteristics** (Continued)

The following specifications apply for Supply Voltage = ±15V,  $R_F = 820\Omega$ , and  $R_L = 1\text{ k}\Omega$  unless otherwise noted. **Boldface** limits apply at the temperature extremes; all other limits  $T_J = 25^\circ\text{C}$ .

Symbol	Parameter	Conditions	LM6181AM		LM6181AI		LM6181I		Units
			Typical (Note 4)	Limit (Note 5)	Typical (Note 4)	Limit (Note 5)	Typical (Note 4)	Limit (Note 5)	
$R_{IN}$	Non-Inverting Input Resistance		10		10		10		M $\Omega$ min
$V_O$	Output Voltage Swing	$R_L = 1\text{ k}\Omega$	12	11 <b>11</b>	12	11 <b>11</b>	12	11 <b>11</b>	V min
		$R_L = 100\Omega$	11	10 <b>7.5</b>	11	10 <b>8.0</b>	11	10 <b>8.0</b>	
$I_{SC}$	Output Short Circuit Current		130	100 <b>75</b>	130	100 <b>85</b>	130	100 <b>85</b>	mA min
$Z_T$	Transimpedance	$R_L = 1\text{ k}\Omega$	1.8	1.0 <b>0.5</b>	1.8	1.0 <b>0.5</b>	1.8	0.8 <b>0.4</b>	M $\Omega$ min
		$R_L = 100\Omega$	1.4	0.8 <b>0.4</b>	1.4	0.8 <b>0.4</b>	1.4	0.7 <b>0.35</b>	
$I_S$	Supply Current	No Load, $V_O = 0V$	7.5	10 <b>10</b>	7.5	10 <b>10</b>	7.5	10 <b>10</b>	mA max
$V_{CM}$	Input Common Mode Voltage Range		$V^+ - 1.7V$ $V^- + 1.7V$		$V^+ - 1.7V$ $V^- + 1.7V$		$V^+ - 1.7V$ $V^- + 1.7V$		V

**±15V AC Electrical Characteristics**

The following specifications apply for Supply Voltage = ±15V,  $R_F = 820\Omega$ ,  $R_L = 1\text{ k}\Omega$  unless otherwise noted. **Boldface** limits apply at the temperature extremes; all other limits  $T_J = 25^\circ\text{C}$ .

Symbol	Parameter	Conditions	LM6181AM		LM6181AI		LM6181I		Units
			Typical (Note 4)	Limit (Note 5)	Typical (Note 4)	Limit (Note 5)	Typical (Note 4)	Limit (Note 5)	
BW	Closed Loop Bandwidth -3 dB	$A_V = +2$	100		100		100		MHz min
		$A_V = +10$	80		80		80		
		$A_V = -1$	100	80	100	80	100	80	
		$A_V = -10$	60		60		60		
PBW	Power Bandwidth	$A_V = -1$ , $V_O = 5 V_{PP}$	60		60		60		
SR	Slew Rate	Overdriven	2000		2000		2000		V/ $\mu\text{s}$ min
		$A_V = -1$ , $V_O = \pm 10V$ , $R_L = 150\Omega$ (Note 6)	1400	1000	1400	1000	1400	1000	
$t_s$	Settling Time (0.1%)	$A_V = -1$ , $V_O = \pm 5V$ $R_L = 150\Omega$	50		50		50		ns
$t_r$ , $t_f$	Rise and Fall Time	$V_O = 1 V_{PP}$	5		5		5		
$t_p$	Propagation Delay Time	$V_O = 1 V_{PP}$	6		6		6		
$i_{n(+)}$	Non-Inverting Input Noise Current Density	$f = 1\text{ kHz}$	3		3		3		pA/ $\sqrt{\text{Hz}}$
$i_{n(-)}$	Inverting Input Noise Current Density	$f = 1\text{ kHz}$	16		16		16		pA/ $\sqrt{\text{Hz}}$
$e_n$	Input Noise Voltage Density	$f = 1\text{ kHz}$	4		4		4		nV/ $\sqrt{\text{Hz}}$

**±15V AC Electrical Characteristics** (Continued)

The following specifications apply for Supply Voltage = ±15V,  $R_F = 820\Omega$ ,  $R_L = 1\text{ k}\Omega$  unless otherwise noted. **Boldface** limits apply at the temperature extremes; all other limits  $T_J = 25^\circ\text{C}$ .

Symbol	Parameter	Conditions	LM6181AM		LM6181AI		LM6181I		Units
			Typical (Note 4)	Limit (Note 5)	Typical (Note 4)	Limit (Note 5)	Typical (Note 4)	Limit (Note 5)	
	Second Harmonic Distortion	$2 V_{PP}$ , 10 MHz	-50		-50		-50		dBc
	Third Harmonic Distortion	$2 V_{PP}$ , 10 MHz	-55		-55		-50		
	Differential Gain	$R_L = 150\Omega$ $A_V = +2$ NTSC	0.05		0.05		0.05		%
	Differential Phase	$R_L = 150\Omega$ $A_V = +2$ NTSC	0.04		0.04		0.04		Deg

## ±5V DC Electrical Characteristics

The following specifications apply for Supply Voltage = ±5V,  $R_F = 820\Omega$ , and  $R_L = 1\text{ k}\Omega$  unless otherwise noted. **Boldface** limits apply at the temperature extremes; all other limits  $T_J = 25^\circ\text{C}$ .

Symbol	Parameter	Conditions	LM6181AM		LM6181AI		LM6181I		Units
			Typical (Note 4)	Limit (Note 5)	Typical (Note 4)	Limit (Note 5)	Typical (Note 4)	Limit (Note 5)	
$V_{OS}$	Input Offset Voltage		1.0	2.0 <b>3.0</b>	1.0	2.0 <b>2.5</b>	1.0	3.0 <b>3.5</b>	mV max
$TC_{V_{OS}}$	Input Offset Voltage Drift		2.5		2.5		2.5		$\mu\text{V}/^\circ\text{C}$
$I_B$	Inverting Input Bias Current		5.0	10 <b>22</b>	5.0	10 <b>22</b>	5.0	17.5 <b>27.0</b>	$\mu\text{A}$ max
	Non-Inverting Input Bias Current		0.25	1.5 <b>1.5</b>	0.25	1.5 <b>1.5</b>	0.25	3.0 <b>5.0</b>	
$TC_{I_B}$	Inverting Input Bias Current Drift		50		50		50		nA/ $^\circ\text{C}$
	Non-Inverting Input Bias Current Drift		3.0		3.0		3.0		
$I_B$ PSR	Inverting Input Bias Current Power Supply Rejection	$V_S = \pm 4.0\text{V}, \pm 6.0\text{V}$	0.3	0.5 <b>0.5</b>	0.3	0.5 <b>0.5</b>	0.3	1.0 <b>1.0</b>	$\mu\text{A}/\text{V}$ max
	Non-Inverting Input Bias Current Power Supply Rejection	$V_S = \pm 4.0\text{V}, \pm 6.0\text{V}$	0.05	0.5 <b>0.5</b>	0.05	0.5 <b>0.5</b>	0.05	0.5 <b>0.5</b>	
$I_B$ CMR	Inverting Input Bias Current Common Mode Rejection	$-2.5\text{V} \leq V_{CM} \leq +2.5\text{V}$	0.3	0.5 <b>1.0</b>	0.3	0.5 <b>1.0</b>	0.3	1.0 <b>1.5</b>	
	Non-Inverting Input Bias Current Common Mode Rejection	$-2.5\text{V} \leq V_{CM} \leq +2.5\text{V}$	0.12	0.5 <b>1.0</b>	0.12	0.5 <b>0.5</b>	0.12	0.5 <b>0.5</b>	
CMRR	Common Mode Rejection Ratio	$-2.5\text{V} \leq V_{CM} \leq +2.5\text{V}$	57	50 <b>47</b>	57	50 <b>47</b>	57	50 <b>47</b>	dB min
PSRR	Power Supply Rejection Ratio	$V_S = \pm 4.0\text{V}, \pm 6.0\text{V}$	80	70 <b>70</b>	80	70 <b>70</b>	80	64 <b>64</b>	
$R_O$	Output Resistance	$A_V = -1, f = 300\text{ kHz}$	0.25		0.25		0.25		$\Omega$
$R_{IN}$	Non-Inverting Input Resistance		8		8		8		$\text{M}\Omega$ min
$V_O$	Output Voltage Swing	$R_L = 1\text{ k}\Omega$	2.6	2.25 <b>2.2</b>	2.6	2.25 <b>2.25</b>	2.6	2.25 <b>2.25</b>	V min
		$R_L = 100\Omega$	2.2	2.0 <b>2.0</b>	2.2	2.0 <b>2.0</b>	2.2	2.0 <b>2.0</b>	
$I_{SC}$	Output Short Circuit Current		100	75 <b>70</b>	100	75 <b>70</b>	100	75 <b>70</b>	mA min
$Z_T$	Transimpedance	$R_L = 1\text{ k}\Omega$	1.4	0.75 <b>0.35</b>	1.4	0.75 <b>0.4</b>	1.0	0.6 <b>0.3</b>	$\text{M}\Omega$ min
		$R_L = 100\Omega$	1.0	0.5 <b>0.25</b>	1.0	0.5 <b>0.25</b>	1.0	0.4 <b>0.2</b>	
$I_S$	Supply Current	No Load, $V_O = 0\text{V}$	6.5	8.5 <b>8.5</b>	6.5	8.5 <b>8.5</b>	6.5	8.5 <b>8.5</b>	mA max
$V_{CM}$	Input Common Mode Voltage Range		$V^+ - 1.7\text{V}$ $V^- + 1.7\text{V}$		$V^+ - 1.7\text{V}$ $V^- + 1.7\text{V}$		$V^+ - 1.7\text{V}$ $V^- + 1.7\text{V}$		V

## ±5V AC Electrical Characteristics

The following specifications apply for Supply Voltage = ±5V,  $R_F = 820\Omega$ , and  $R_L = 1\text{ k}\Omega$  unless otherwise noted. **Boldface** limits apply at the temperature extremes; all other limits  $T_J = 25^\circ\text{C}$ .

Symbol	Parameter	Conditions	LM6181AM		LM6181AI		LM6181I		Units
			Typical (Note 4)	Limit (Note 5)	Typical (Note 4)	Limit (Note 5)	Typical (Note 4)	Limit (Note 5)	
BW	Closed Loop Bandwidth -3 dB	$A_V = +2$	50		50		50		MHz min
		$A_V = +10$	40		40		40		
		$A_V = -1$	55	35	55	35	55	35	
		$A_V = -10$	35		35		35		
PBW	Power Bandwidth	$A_V = -1, V_O = 4$ $V_{PP}$	40		40		40		
SR	Slew Rate	$A_V = -1, V_O = \pm 2V,$ $R_L = 150\Omega$ (Note 6)	500	375	500	375	500	375	V/ $\mu\text{s}$ min
$t_s$	Settling Time (0.1%)	$A_V = -1, V_O = \pm 2V$ $R_L = 150\Omega$	50		50		50		ns
$t_r, t_f$	Rise and Fall Time	$V_O = 1 V_{PP}$	8.5		8.5		8.5		
$t_p$	Propagation Delay Time	$V_O = 1 V_{PP}$	8		8		8		
$i_{n(+)}$	Non-Inverting Input Noise Current Density	$f = 1\text{ kHz}$	3		3		3		$\text{pA}/\sqrt{\text{Hz}}$
$i_{n(-)}$	Inverting Input Noise Current Density	$f = 1\text{ kHz}$	16		16		16		$\text{pA}/\sqrt{\text{Hz}}$
$e_n$	Input Noise Voltage Density	$f = 1\text{ kHz}$	4		4		4		$\text{nV}/\sqrt{\text{Hz}}$
	Second Harmonic Distortion	$2 V_{PP}, 10\text{ MHz}$	-45		-45		-45		dBc
	Third Harmonic Distortion	$2 V_{PP}, 10\text{ MHz}$	-55		-55		-55		
	Differential Gain	$R_L = 150\Omega$ $A_V = +2$ NTSC	0.063		0.063		0.063		%
	Differential Phase	$R_L = 150\Omega$ $A_V = +2$ NTSC	0.16		0.16		0.16		Deg

**Note 1:** Absolute Maximum Ratings indicate limits beyond which damage to the device may occur. Operating ratings indicate conditions the device is intended to be functional, but device parameter specifications may not be guaranteed under these conditions. For guaranteed specifications and test conditions, see the Electrical Characteristics.

**Note 2:** Human body model 100 pF and 1.5 k $\Omega$ .

**Note 3:** The typical junction-to-ambient thermal resistance of the molded plastic DIP(N) package soldered directly into a PC board is 102°C/W. The junction-to-ambient thermal resistance of the S.O. surface mount (M) package mounted flush to the PC board is 70°C/W when pins 1, 4, 8, 9 and 16 are soldered to a total 2 in<sup>2</sup> 1 oz. copper trace. The 16-pin S.O. (M) package must have pin 4 and at least one of pins 1, 8, 9, or 16 connected to  $V^-$  for proper operation. The typical junction-to-ambient thermal resistance of the S.O. (M-8) package soldered directly into a PC board is 153°C/W.

**Note 4:** Typical values represent the most likely parametric norm.

**Note 5:** All limits guaranteed at room temperature (standard type face) or at operating temperature extremes (**bold face type**).

**Note 6:** Measured from +25% to +75% of output waveform.

**Note 7:** Continuous short circuit operation at elevated ambient temperature can result in exceeding the maximum allowed junction temperature of 150°C. Output currents in excess of ±130 mA over a long term basis may adversely affect reliability.

**Note 8:** For guaranteed Military Temperature Range parameters see RETS6181X.

## Typical Performance Characteristics

$T_A = 25^\circ\text{C}$  unless otherwise noted

### CLOSED-LOOP FREQUENCY RESPONSE

$V_S = \pm 15\text{V}$ ;  $R_f = 820\Omega$ ;  
 $R_L = 1\text{ k}\Omega$

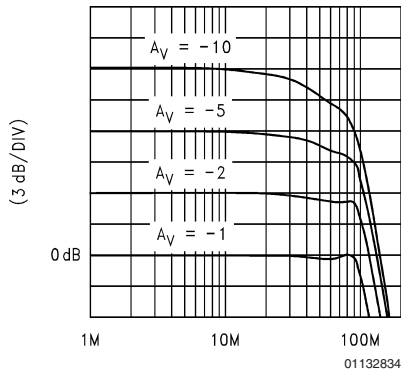

### CLOSED-LOOP FREQUENCY RESPONSE

$V_S = \pm 15\text{V}$ ;  $R_f = 820\Omega$ ;  
 $R_L = 150\Omega$

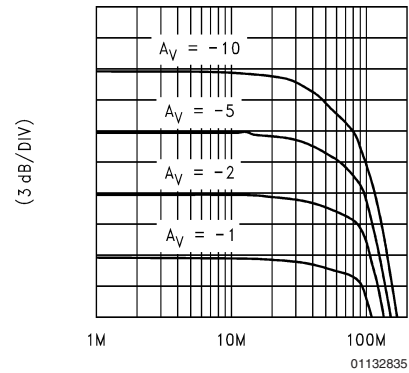

### UNITY GAIN FREQUENCY RESPONSE

$V_S = \pm 15\text{V}$ ;  $A_V = +1$ ;  
 $R_f = 820\Omega$

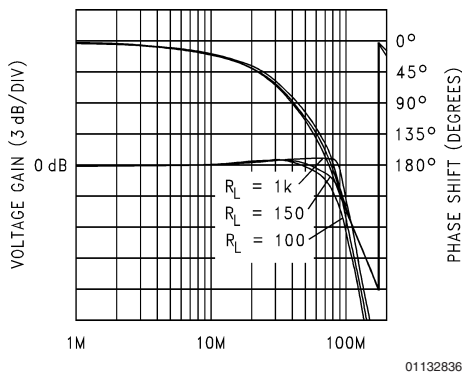

### UNITY GAIN FREQUENCY RESPONSE

$V_S = \pm 5\text{V}$ ;  $A_V = +1$ ;  
 $R_f = 820\Omega$

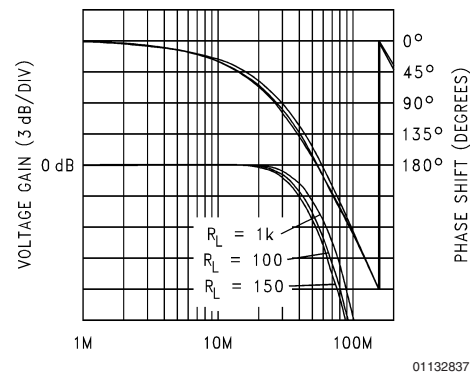

### FREQUENCY RESPONSE vs SUPPLY VOLTAGE

$A_V = -1$ ;  $R_f = 820\Omega$ ;  
 $R_L = 1\text{ k}\Omega$

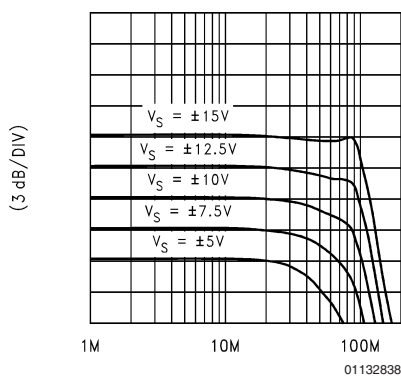

### FREQUENCY RESPONSE vs SUPPLY VOLTAGE

$A_V = -1$ ;  $R_f = 820\Omega$ ;  
 $R_L = 150\Omega$

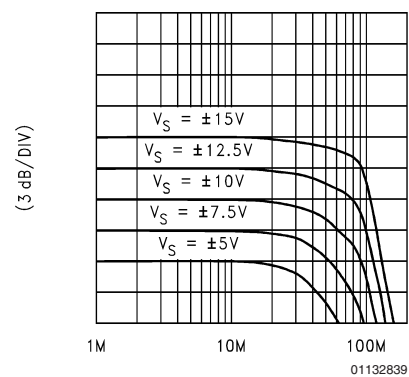

# Typical Performance Characteristics $T_A = 25^\circ\text{C}$ unless otherwise noted (Continued)

**INVERTING GAIN  
FREQUENCY RESPONSE**  
 $V_S = \pm 15\text{V}; A_V = -1;$   
 $R_f = 820\Omega$

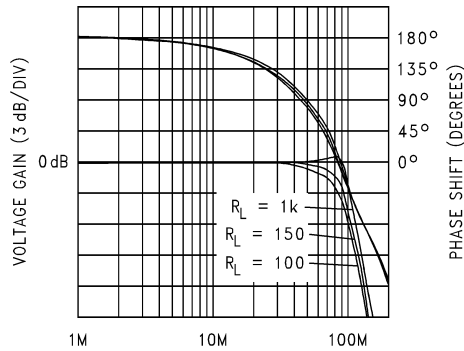

01132840

**INVERTING GAIN  
FREQUENCY RESPONSE**  
 $V_S = \pm 5\text{V}; A_V = -1;$   
 $R_f = 820\Omega$

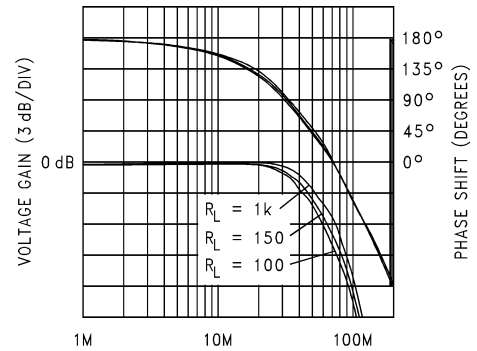

01132841

**NON-INVERTING GAIN  
FREQUENCY RESPONSE**  
 $V_S = \pm 15\text{V}; A_V = +2;$   
 $R_f = 820\Omega$

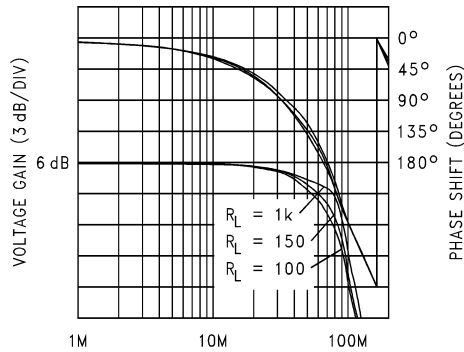

01132842

**NON-INVERTING GAIN  
FREQUENCY RESPONSE**  
 $V_S = \pm 5\text{V}; A_V = +2;$   
 $R_f = 820\Omega$

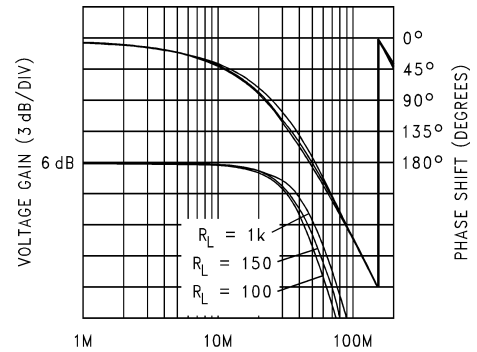

01132843

**INVERTING GAIN  
FREQUENCY RESPONSE**  
 $V_S = \pm 15\text{V}; A_V = -10;$   
 $R_f = 820\Omega$

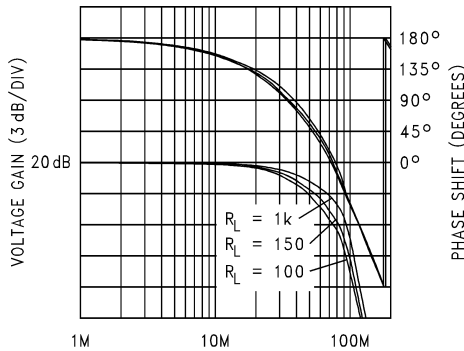

01132844

**INVERTING GAIN  
FREQUENCY RESPONSE**  
 $V_S = \pm 5\text{V}; A_V = -10;$   
 $R_f = 820\Omega$

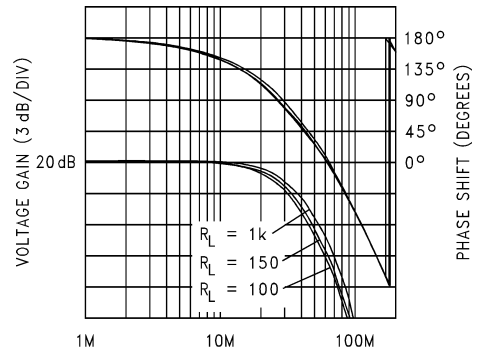

01132845



**Typical Performance Characteristics**  $T_A = 25^\circ\text{C}$  unless otherwise noted (Continued)

**NON-INVERTING GAIN  
FREQUENCY RESPONSE**  
 $V_S = \pm 15\text{V}; A_V = +10;$   
 $R_f = 820\Omega$

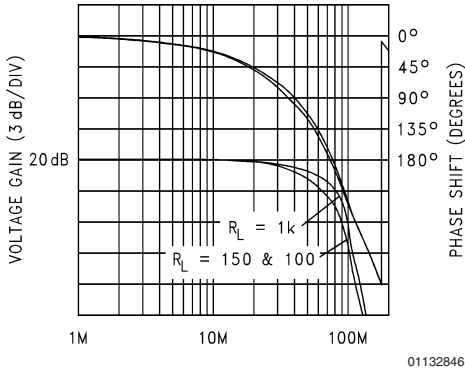

**NON-INVERTING GAIN  
FREQUENCY RESPONSE**  
 $V_S = \pm 5\text{V}; A_V = +10;$   
 $R_f = 820\Omega$

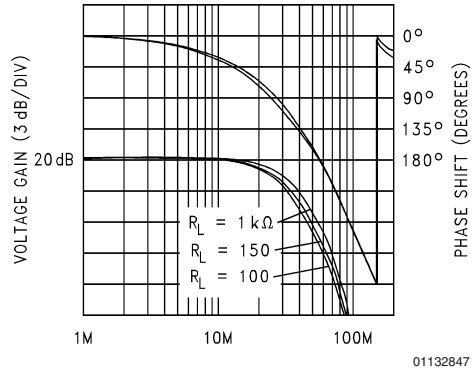

**NON-INVERTING GAIN  
FREQUENCY COMPENSATION**  
 $V_S = \pm 15\text{V}; A_V = +2;$   
 $R_L = 150\Omega$

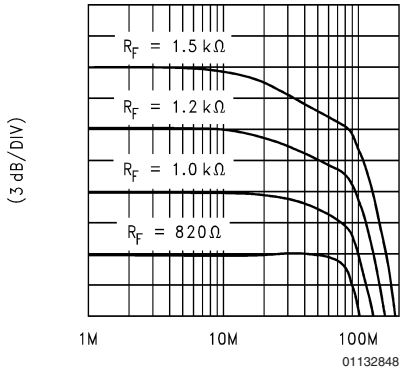

**BANDWIDTH vs  $R_f$  &  $R_S$**   
 $A_V = -1, R_L = 1\text{ k}\Omega$

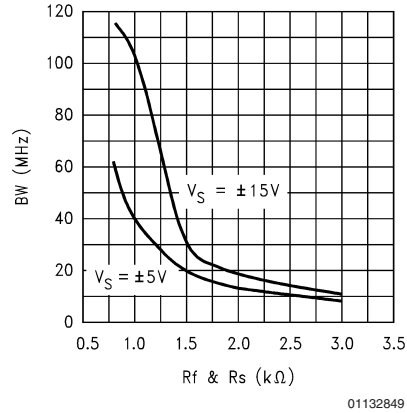

**OUTPUT SWING vs  
 $R_{LOAD}$  PULSED,  $V_S = \pm 15\text{V},$   
 $I_{IN} = \pm 200\ \mu\text{A}, V_{IN+} = 0\text{V}$**

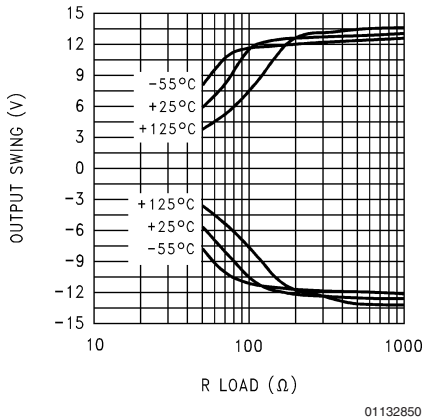

**TRANSIMPEDANCE  
vs FREQUENCY**  
 $V_S = \pm 15\text{V}$   
 $R_L = 1\text{ k}\Omega$

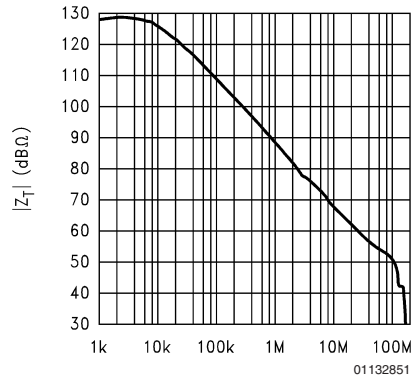

**Typical Performance Characteristics**  $T_A = 25^\circ\text{C}$  unless otherwise noted (Continued)

**TRANSIMPEDANCE vs FREQUENCY**  
 $V_S = \pm 15\text{V}$   
 $R_L = 100\Omega$

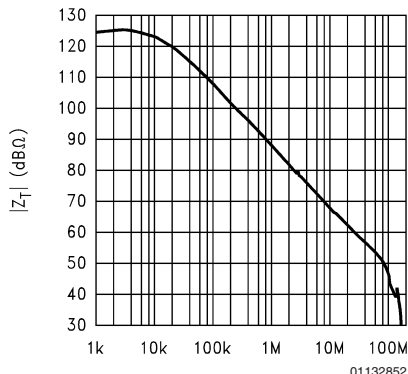

**TRANSIMPEDANCE vs FREQUENCY**  
 $V_S = \pm 5\text{V}$   
 $R_L = 1\text{ k}\Omega$

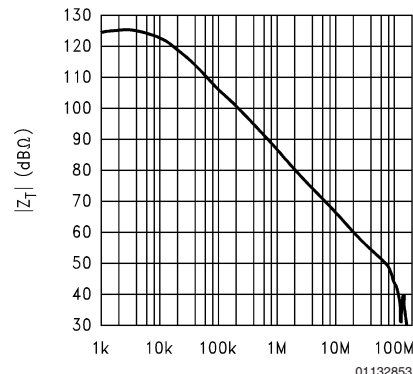

**SETTLING RESPONSE**  
 $V_S = \pm 15\text{V}; R_L = 150\Omega;$   
 $V_O = \pm 5\text{V}; A_V = -1$

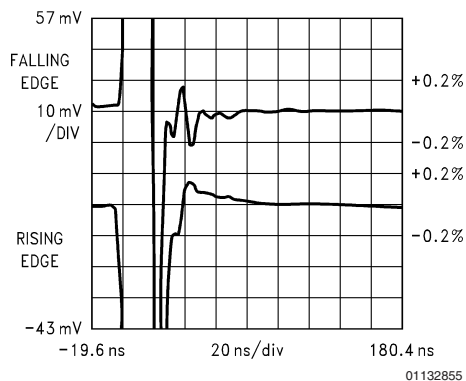

**SETTLING RESPONSE**  
 $V_S = \pm 5\text{V}; R_L = 150\Omega;$   
 $V_O = \pm 2\text{V}; A_V = -1$

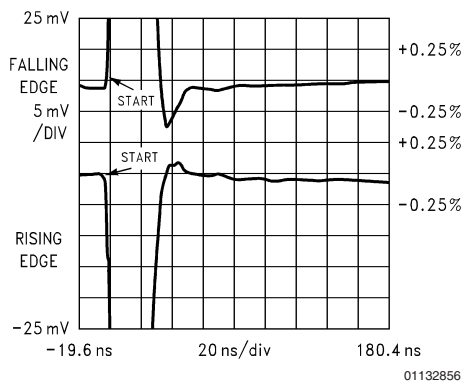

**SUGGESTED  $R_f$  and  $R_s$  for  $C_L$**   
 $A_V = -1; R_L = 150\Omega$

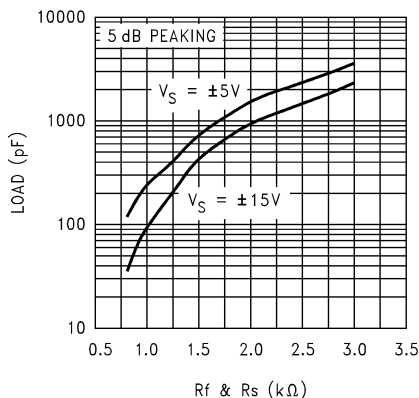

**TRANSIMPEDANCE vs FREQUENCY**  
 $V_S = \pm 5\text{V}$   
 $R_L = 100\Omega$

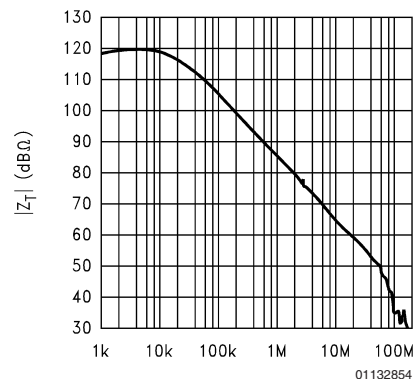

**Typical Performance Characteristics**  $T_A = 25^\circ\text{C}$  unless otherwise noted (Continued)

**SUGGESTED  $R_f$  and  $R_S$  FOR  $C_L$**   
 $A_V = -1$

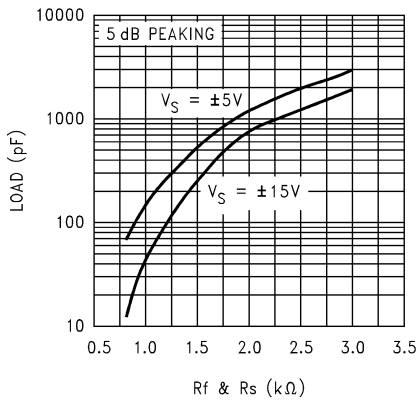

01132858

**SUGGESTED  $R_f$  and  $R_S$  FOR  $C_L$**   
 $A_V = +2; R_L = 150\Omega$

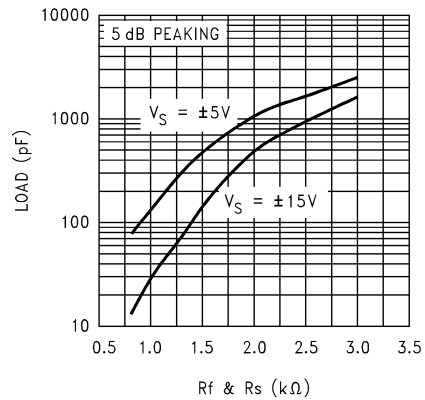

01132859

**SUGGESTED  $R_f$  and  $R_S$  FOR  $C_L$**   
 $A_V = +2$

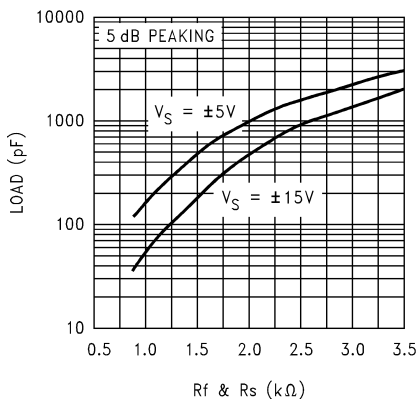

01132860

**OUTPUT IMPEDANCE vs FREQ**  
 $V_S = \pm 15V; A_V = -1$   
 $R_f = 820\Omega$

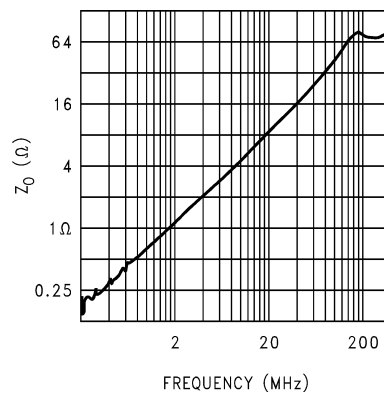

01132861

**OUTPUT IMPEDANCE vs FREQ**  
 $V_S = \pm 5V; A_V = -1$   
 $R_f = 820\Omega$

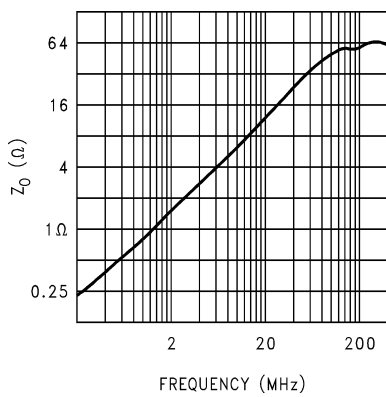

01132862

**PSRR ( $V_S^+$ ) vs FREQUENCY**

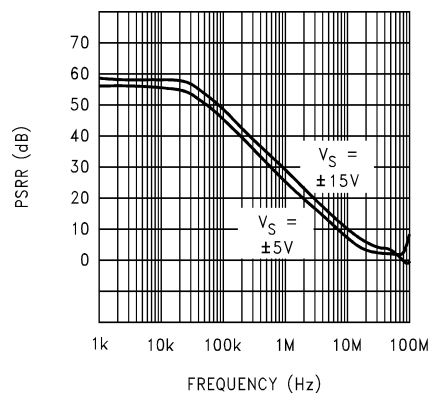

01132863

**Typical Performance Characteristics**  $T_A = 25^\circ\text{C}$  unless otherwise noted (Continued)

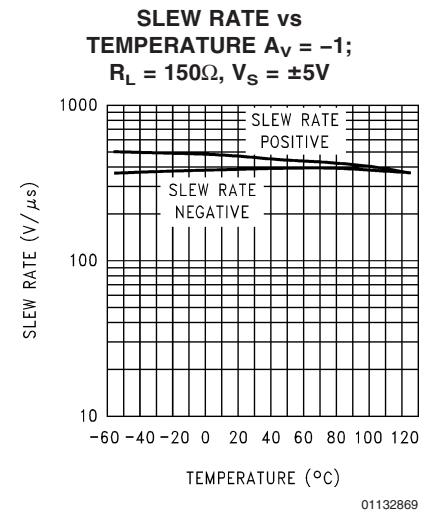
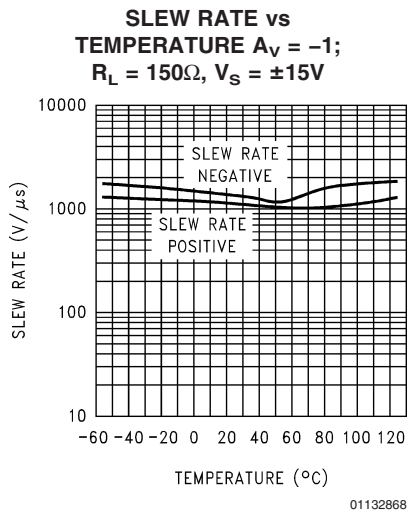
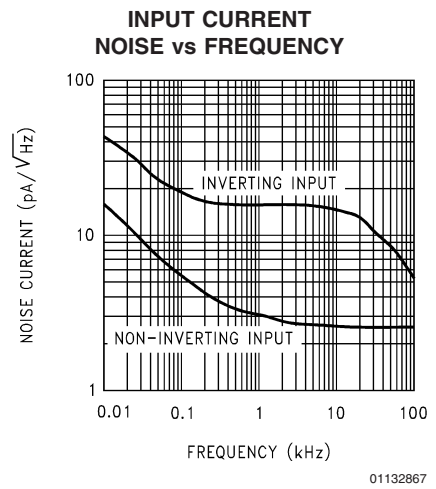
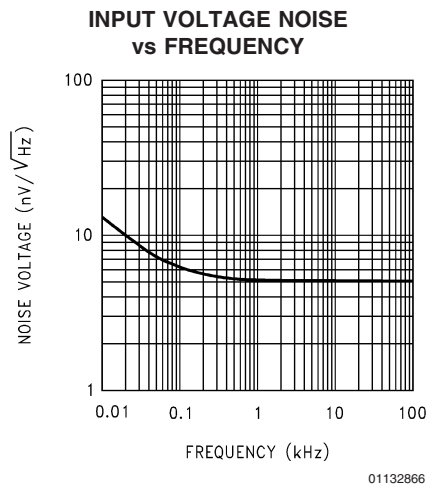
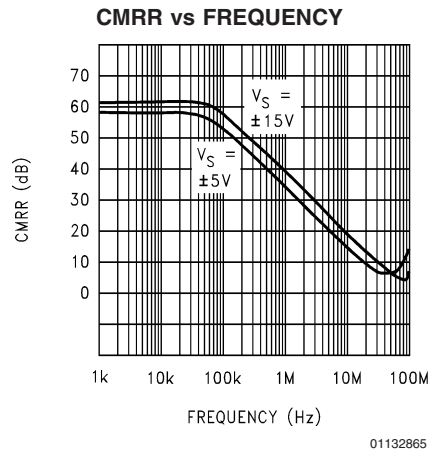
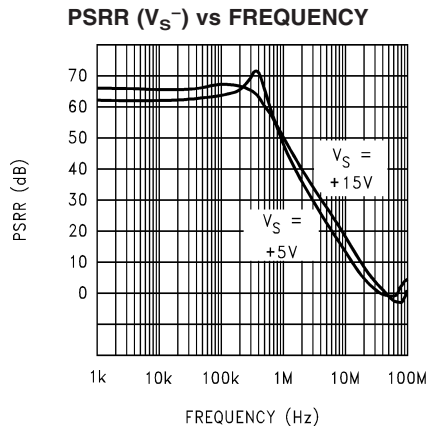

**Typical Performance Characteristics**  $T_A = 25^\circ\text{C}$  unless otherwise noted (Continued)

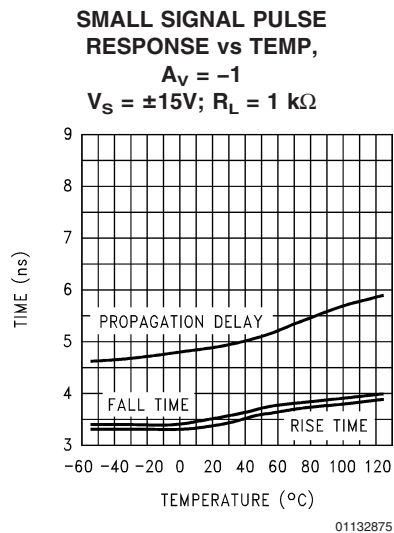
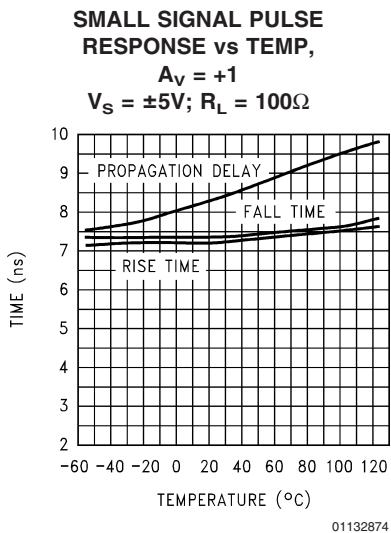
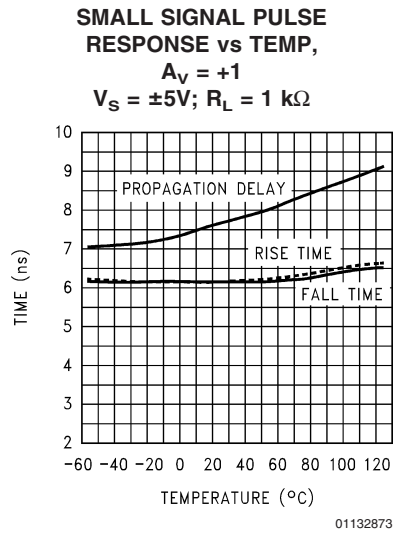
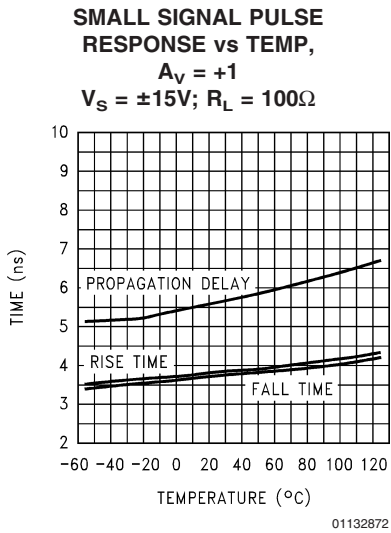
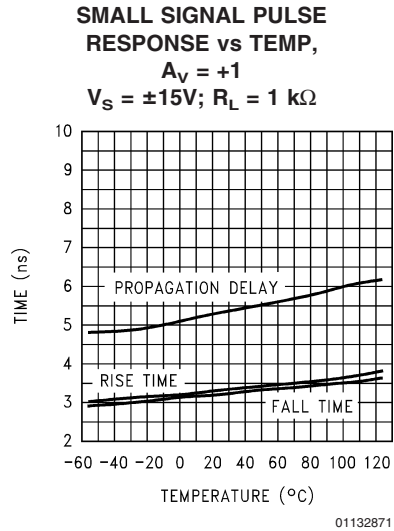
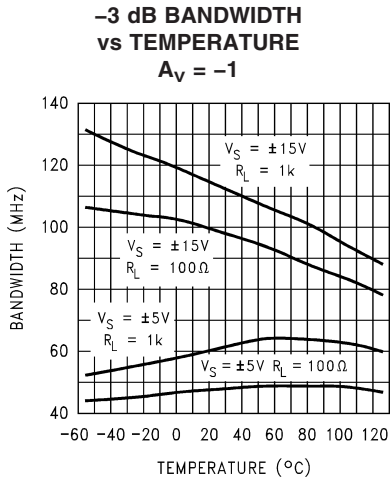

# Typical Performance Characteristics $T_A = 25^\circ\text{C}$ unless otherwise noted (Continued)

**SMALL SIGNAL PULSE  
RESPONSE vs TEMP,  
 $A_V = -1$   
 $V_S = \pm 15\text{V}; R_L = 100\Omega$**

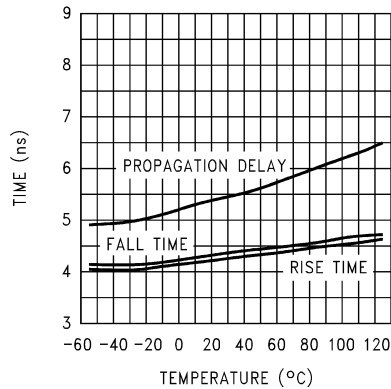

**SMALL SIGNAL PULSE  
RESPONSE vs TEMP,  
 $A_V = -1$   
 $V_S = \pm 5\text{V}; R_L = 1\text{k}\Omega$**

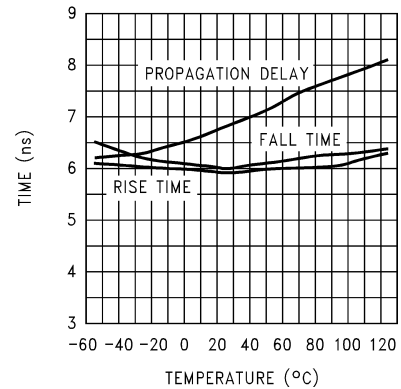

**SMALL SIGNAL PULSE  
RESPONSE vs TEMP,  
 $A_V = -1$   
 $V_S = \pm 5\text{V}; R_L = 100\Omega$**

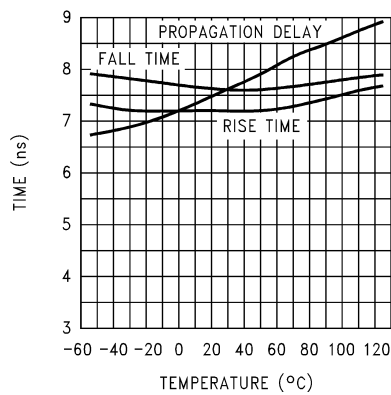

**SMALL SIGNAL PULSE  
RESPONSE vs TEMP,  
 $A_V = +2$   
 $V_S = \pm 15\text{V}; R_L = 1\text{k}\Omega$**

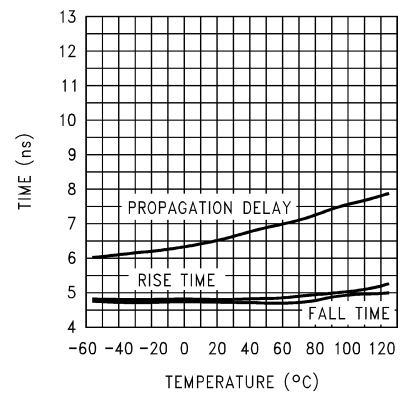

**SMALL SIGNAL PULSE  
RESPONSE vs TEMP,  
 $A_V = +2$   
 $V_S = \pm 15\text{V}; R_L = 100\Omega$**

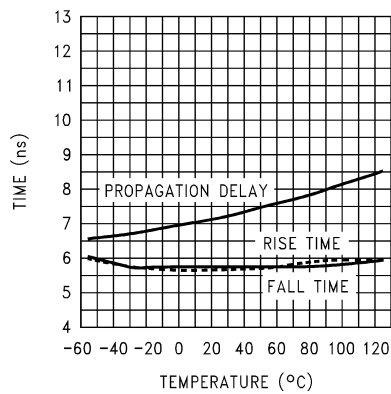

**SMALL SIGNAL PULSE  
RESPONSE vs TEMP,  
 $A_V = +2$   
 $V_S = \pm 5\text{V}; R_L = 1\text{k}\Omega$**

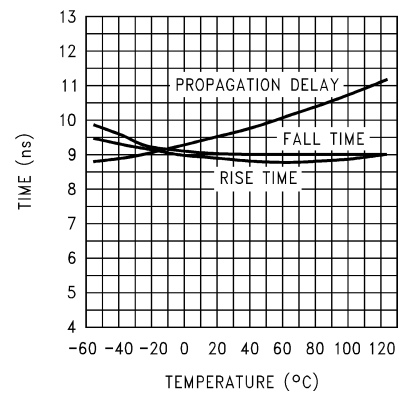

**Typical Performance Characteristics**  $T_A = 25^\circ\text{C}$  unless otherwise noted (Continued)

**SMALL SIGNAL PULSE RESPONSE vs TEMP,**  
 $A_V = +2$   
 $V_S = \pm 5\text{V}; R_L = 100\Omega$

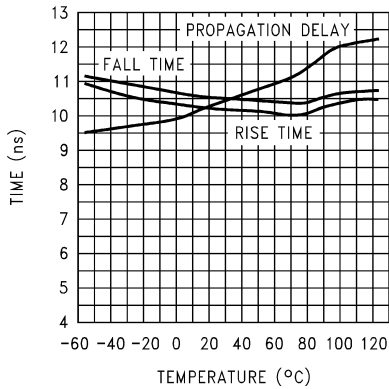

01132882

**SMALL SIGNAL PULSE RESPONSE vs TEMP,**  
 $A_V = -10$   
 $V_S = \pm 15\text{V}; R_L = 1\text{ k}\Omega$

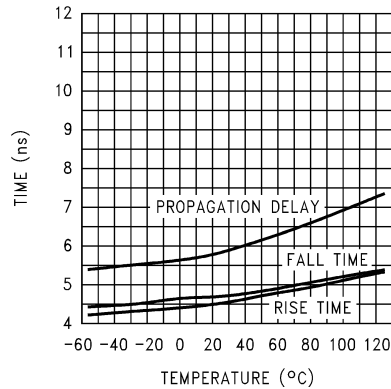

01132883

**SMALL SIGNAL PULSE RESPONSE vs TEMP,**  
 $A_V = -10$   
 $V_S = \pm 15\text{V}; R_L = 100\Omega$

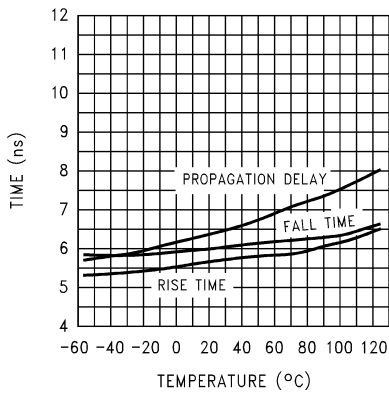

01132884

**SMALL SIGNAL PULSE RESPONSE vs TEMP,**  
 $A_V = -10$   
 $V_S = \pm 5\text{V}; R_L = 1\text{ k}\Omega$

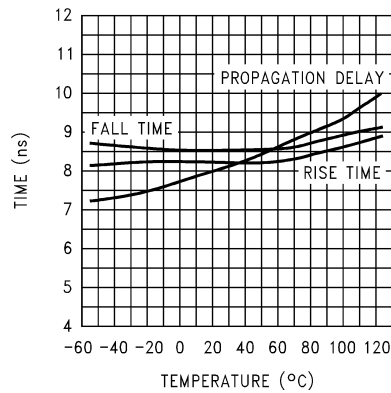

01132885

**SMALL SIGNAL PULSE RESPONSE vs TEMP,**  
 $A_V = -10$   
 $V_S = \pm 5\text{V}; R_L = 100\Omega$

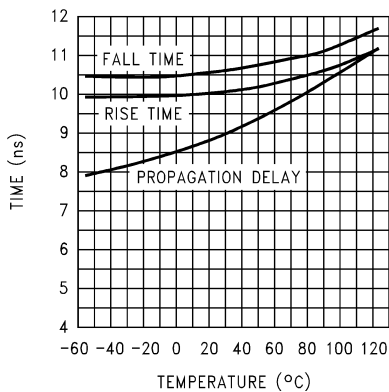

01132886

**SMALL SIGNAL PULSE RESPONSE vs TEMP,**  
 $A_V = +10$   
 $V_S = \pm 15\text{V}; R_L = 1\text{ k}\Omega$

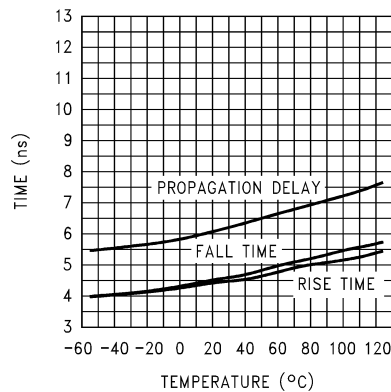

01132887

**Typical Performance Characteristics**  $T_A = 25^\circ\text{C}$  unless otherwise noted (Continued)

**SMALL SIGNAL PULSE RESPONSE vs TEMP,**  
 $A_V = +10$   
 $V_S = \pm 15\text{V}; R_L = 100\Omega$

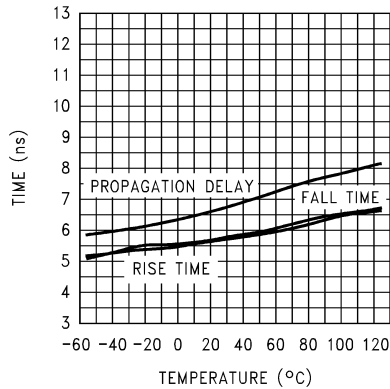

**SMALL SIGNAL PULSE RESPONSE vs TEMP,**  
 $A_V = +10$   
 $V_S = \pm 5\text{V}; R_L = 1\text{ k}\Omega$

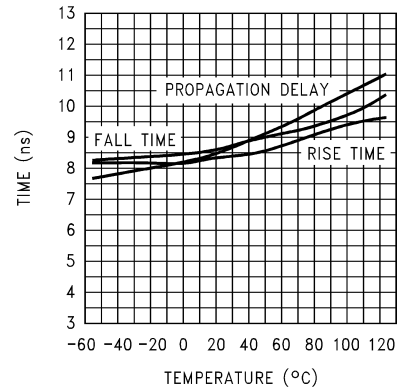

**SMALL SIGNAL PULSE RESPONSE vs TEMP,**  
 $A_V = +10$   
 $V_S = \pm 5\text{V}; R_L = 100\Omega$

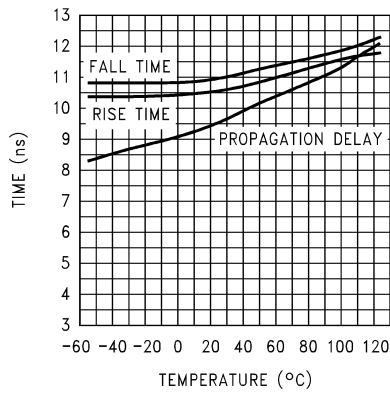

**OFFSET VOLTAGE vs TEMPERATURE**

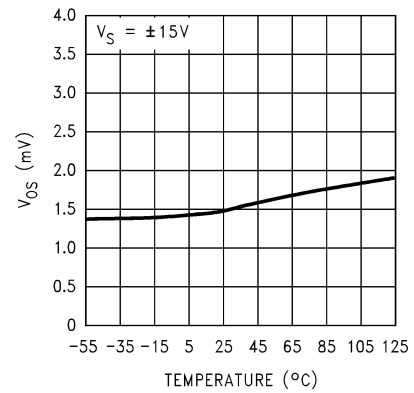

**OFFSET VOLTAGE vs TEMPERATURE**

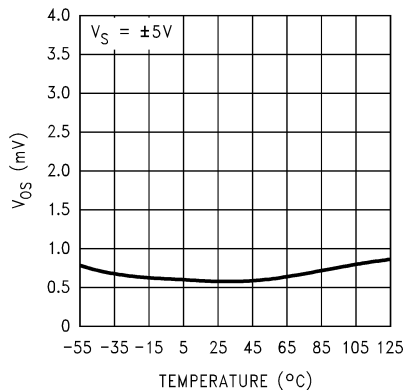

**TRANSIMPEDANCE vs TEMPERATURE**

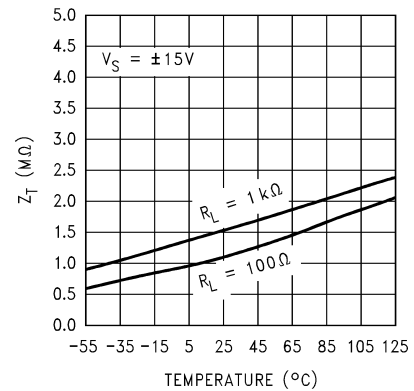



**Typical Performance Characteristics**  $T_A = 25^\circ\text{C}$  unless otherwise noted (Continued)

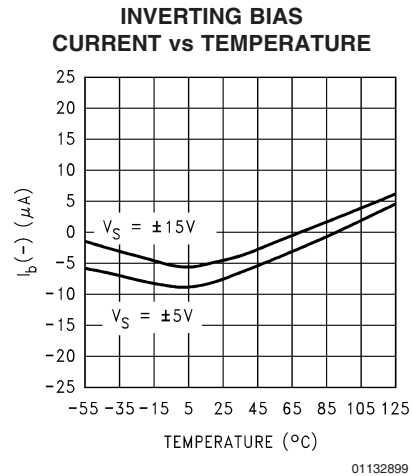
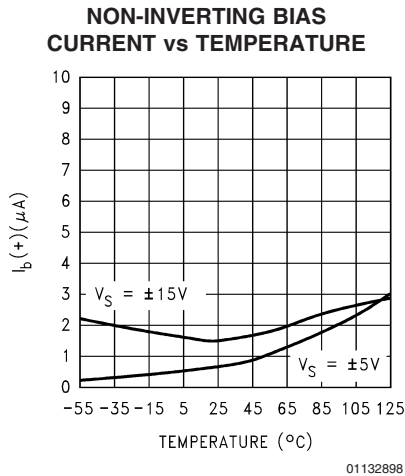
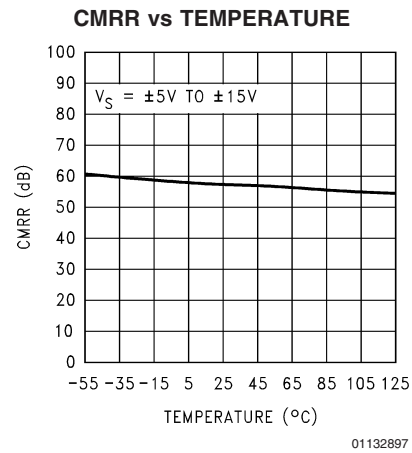
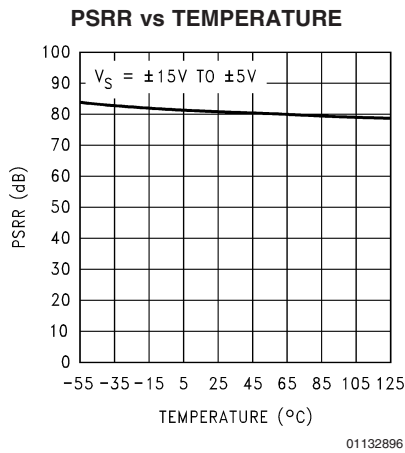
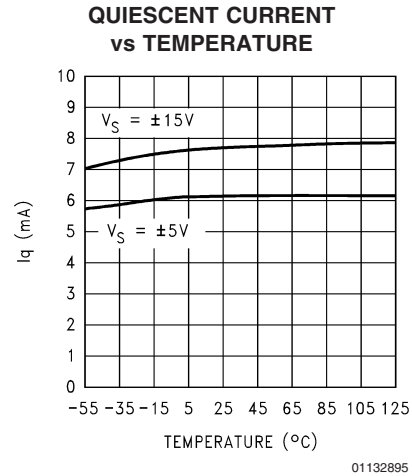
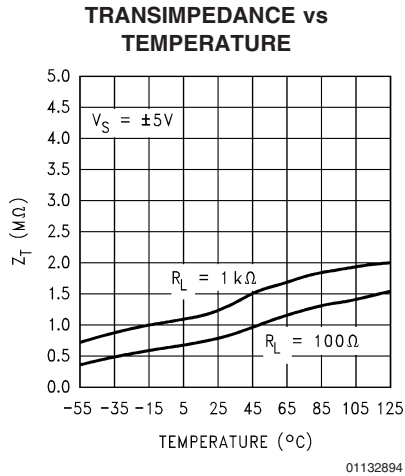

**Typical Performance Characteristics**  $T_A = 25^\circ\text{C}$  unless otherwise noted (Continued)

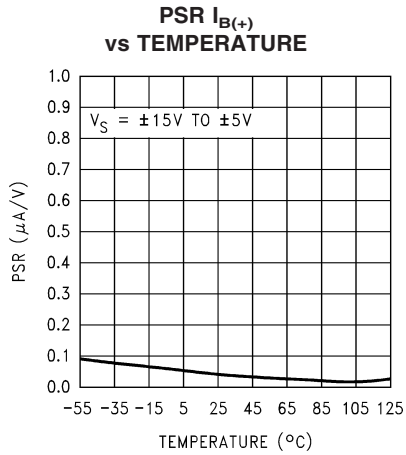

011328A0

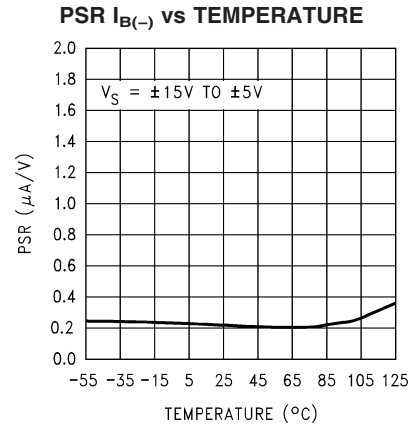

011328A1

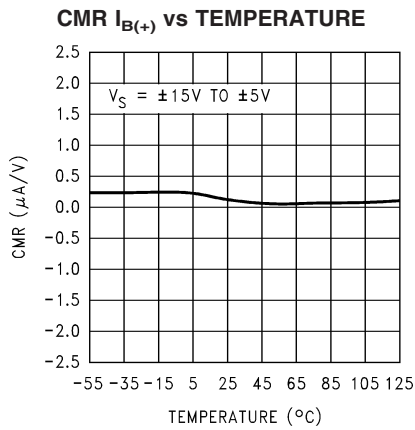

011328A2

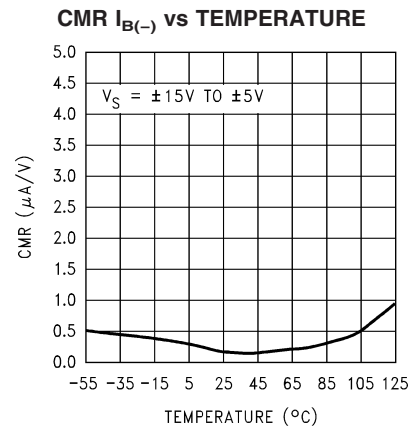

011328A3

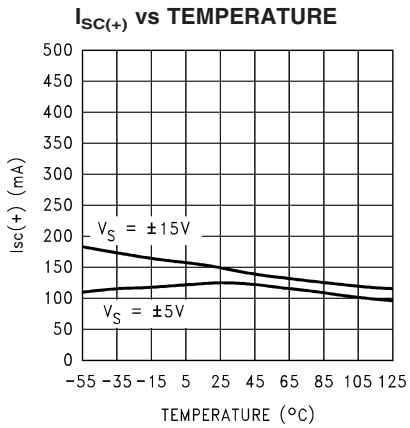

011328A6

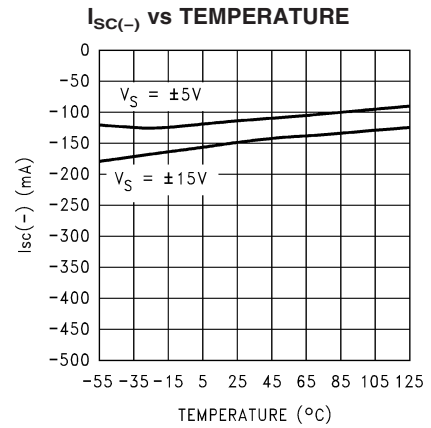

011328A4

# Typical Performance Characteristics

## Absolute Maximum Power Derating Curves

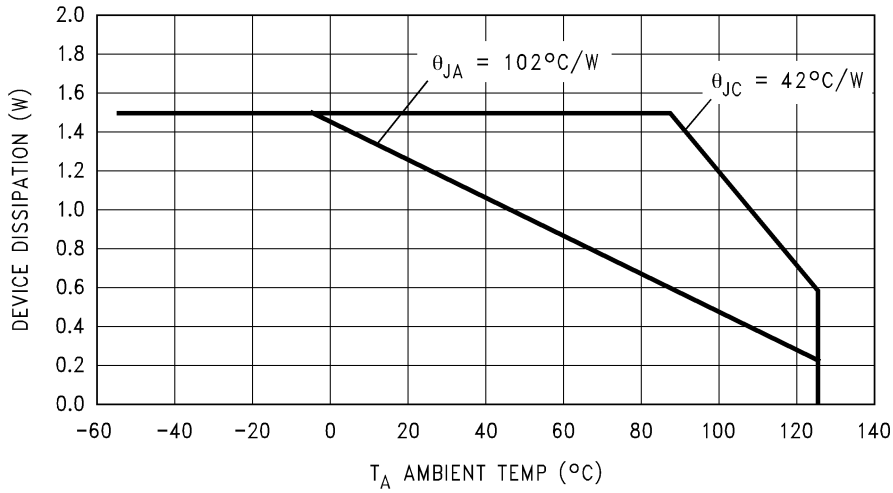

01132830

### N-Package

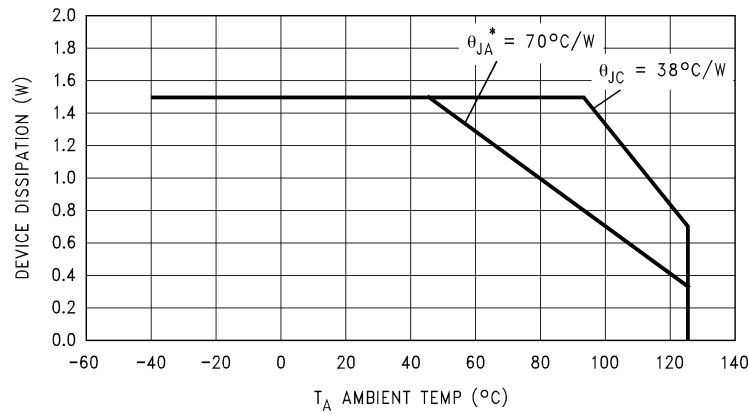

01132831

\* $\theta_{JA}$  = Thermal Resistance with 2 square inches of 1 ounce Copper tied to Pins 1, 8, 9 and 16.

### M-Package

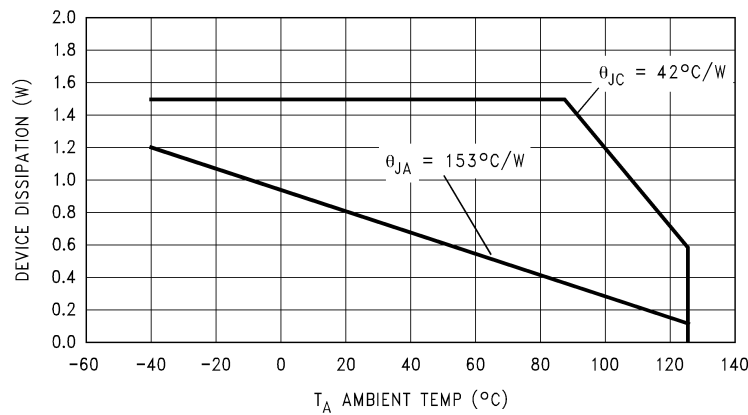

01132833

### M-8 Package

# Typical Performance Characteristics (Continued)

Simplified Schematic

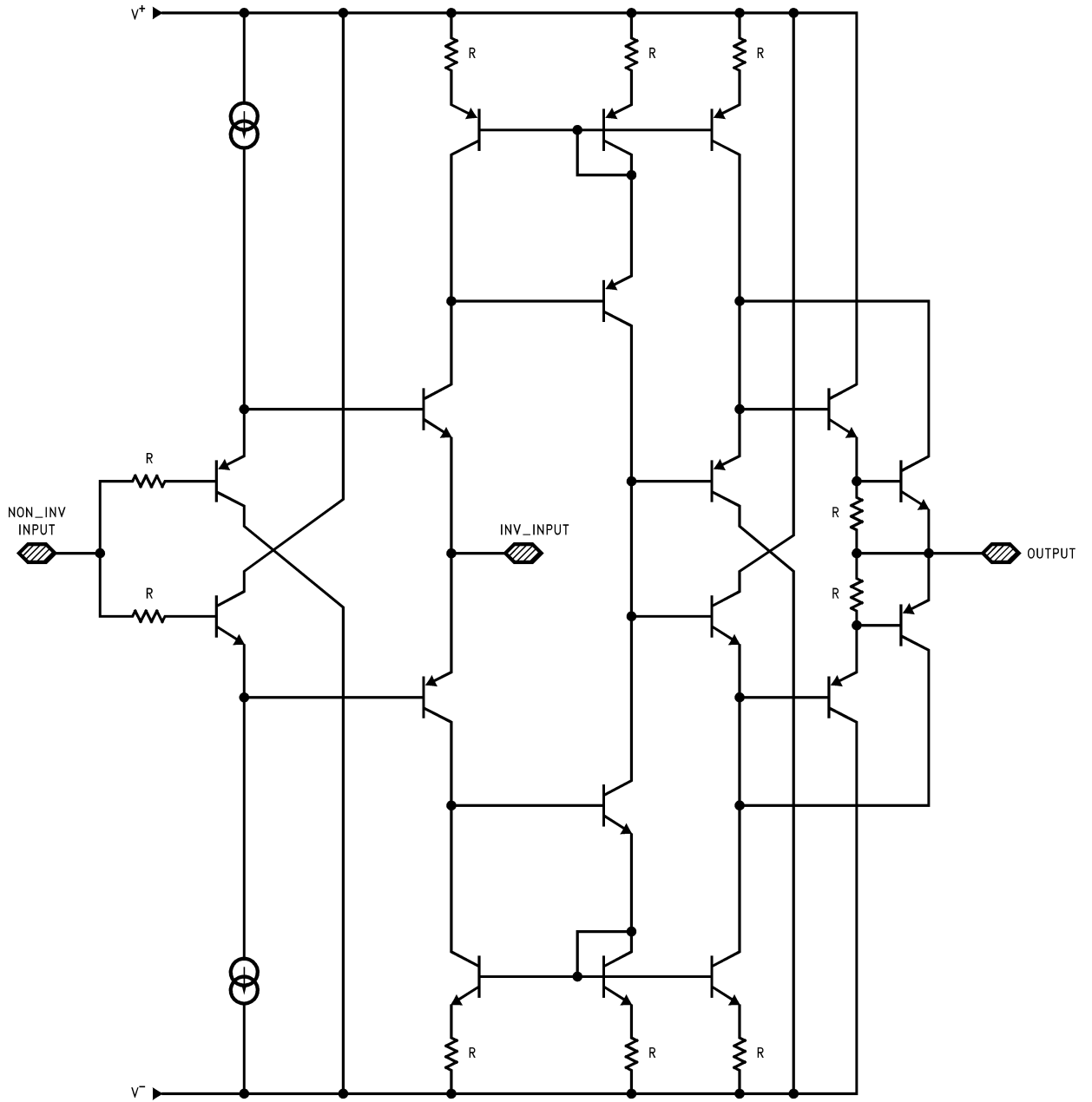

01132832

## Typical Applications

### CURRENT FEEDBACK TOPOLOGY

For a conventional voltage feedback amplifier the resulting small-signal bandwidth is inversely proportional to the desired gain to a first order approximation based on the gain-bandwidth concept. In contrast, the current feedback amplifier topology, such as the LM6181, transcends this limitation to offer a signal bandwidth that is relatively independent of the closed-loop gain. *Figure 1a* and *Figure 1b* illustrate that for closed loop gains of  $-1$  and  $-5$  the resulting pulse fidelity suggests quite similar bandwidths for both configurations.

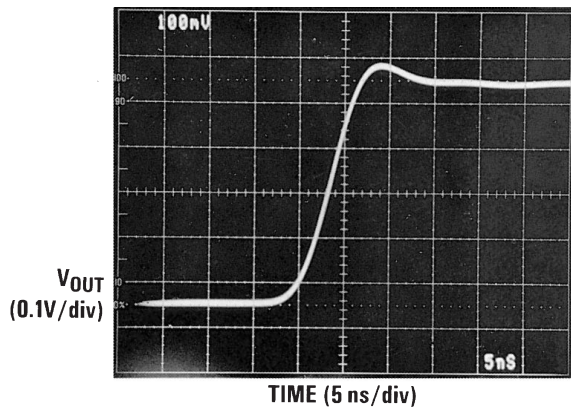

1a

01132812

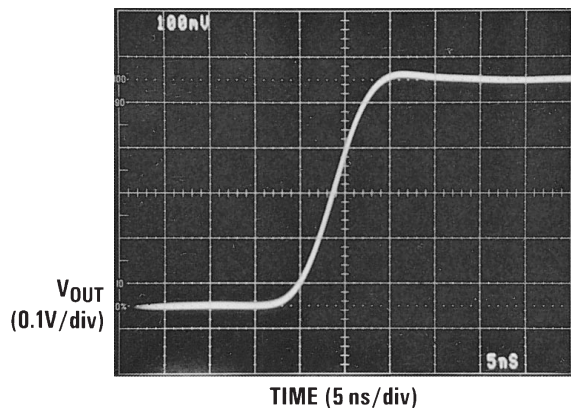

1b

01132813

**FIGURE 1. 1a, 1b: Variation of Closed Loop Gain from  $-1$  to  $-5$  Yields Similar Responses**

The closed-loop bandwidth of the LM6181 depends on the feedback resistance,  $R_f$ . Therefore,  $R_s$  and not  $R_f$ , must be varied to adjust for the desired closed-loop gain as in *Figure 2*.

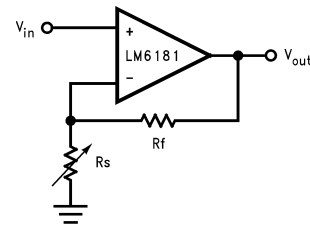

01132814

**FIGURE 2.  $R_s$  Is Adjusted to Obtain the Desired Closed Loop Gain,  $A_{VCL}$**

### POWER SUPPLY BYPASSING AND LAYOUT CONSIDERATIONS

A fundamental requirement for high-speed amplifier design is adequate bypassing of the power supply. It is critical to maintain a wideband low-impedance to ground at the amplifiers supply pins to insure the fidelity of high speed amplifier transient signals.  $10\ \mu\text{F}$  tantalum and  $0.1\ \mu\text{F}$  ceramic bypass capacitors are recommended for each supply pin. The bypass capacitors should be placed as close to the amplifier pins as possible ( $0.5''$  or less).

### FEEDBACK RESISTOR SELECTION: $R_f$

Selecting the feedback resistor,  $R_f$ , is a dominant factor in compensating the LM6181. For general applications the LM6181 will maintain specified performance with an  $820\ \Omega$  feedback resistor. Although this value will provide good results for most applications, it may be advantageous to adjust this value slightly. Consider, for instance, the effect on pulse responses with two different configurations where both the closed-loop gains are 2 and the feedback resistors are  $820\ \Omega$  and  $1640\ \Omega$ , respectively. *Figure 3a* and *Figure 3b* illustrate the effect of increasing  $R_f$  while maintaining the same closed-loop gain—the amplifier bandwidth decreases. Accordingly, larger feedback resistors can be used to slow down the LM6181 (see  $-3\ \text{dB}$  bandwidth vs  $R_f$  typical curves) and reduce overshoot in the time domain response. Conversely, smaller feedback resistance values than  $820\ \Omega$  can be used to compensate for the reduction of bandwidth at high closed loop gains, due to 2nd order effects. For example *Figure 4* illustrates reducing  $R_f$  to  $500\ \Omega$  to establish the desired small signal response in an amplifier configured for a closed loop gain of 25.

Typical Applications (Continued)

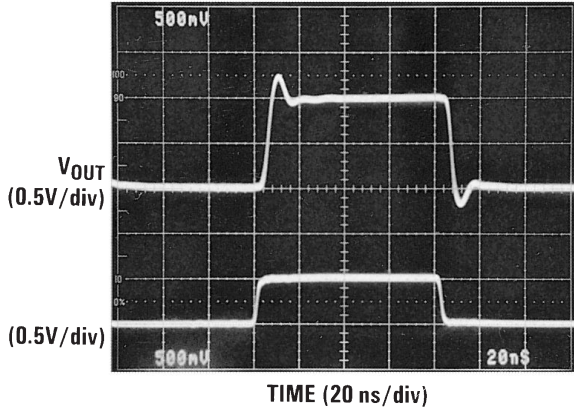

3a:  $R_f = 820\Omega$

01132815

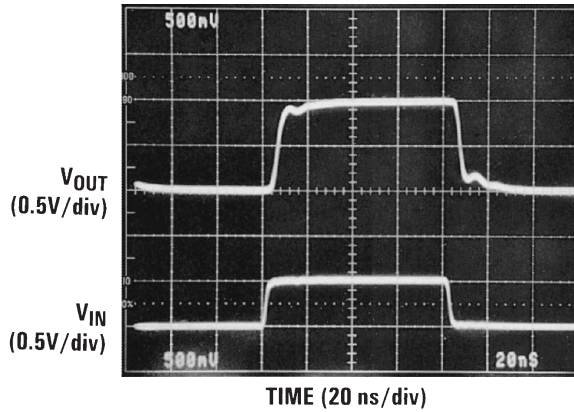

3b:  $R_f = 1640\Omega$

01132816

FIGURE 3. Increasing Compensation with Increasing  $R_f$

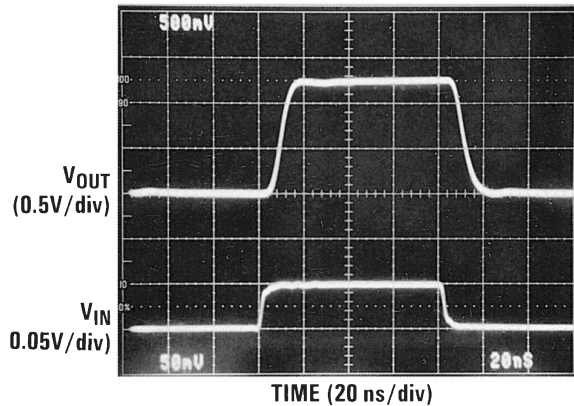

FIGURE 4. Reducing  $R_f$  for Large Closed Loop Gains,  $R_f = 500\Omega$

01132817

SLEW RATE CONSIDERATIONS

The slew rate characteristics of current feedback amplifiers are different than traditional voltage feedback amplifiers. In voltage feedback amplifiers slew rate limiting or non-linear amplifier behavior is dominated by the finite availability of the 1st stage tail current charging the compensation capacitor. The slew rate of current feedback amplifiers, in contrast, is not constant. Transient current at the inverting input determines slew rate for both inverting and non-inverting gains. The non-inverting configuration slew rate is also determined by input stage limitations. Accordingly, variations of slew rates occur for different circuit topologies.

DRIVING CAPACITIVE LOADS

The LM6181 can drive significantly larger capacitive loads than many current feedback amplifiers. Although the LM6181 can directly drive as much as 100 pF without oscillating, the resulting response will be a function of the feedback resistor value. Figure 5 illustrates the small-signal pulse response of the LM6181 while driving a 50 pF load. Ringing persists for approximately 70 ns. To achieve pulse responses with less ringing either the feedback resistor can be increased (see typical curves Suggested  $R_f$  and  $R_s$  for  $C_L$ ), or resistive isolation can be used (10Ω–51Ω typically works well). Either technique, however, results in lowering the system bandwidth.

Figure 6 illustrates the improvement obtained with using a 47Ω isolation resistor.

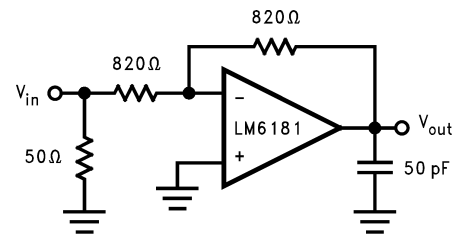

5a

01132818

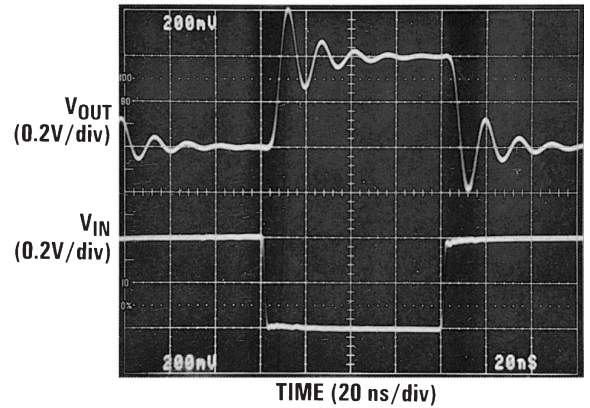

5b

01132819

FIGURE 5.  $A_v = -1$ , LM6181 Can Directly Drive 50 pF of Load Capacitance with 70 ns of Ringing Resulting in Pulse Response

## Typical Applications (Continued)

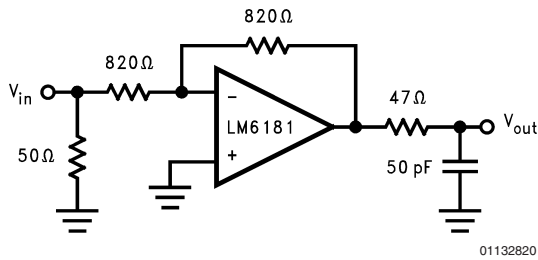

6a

01132820

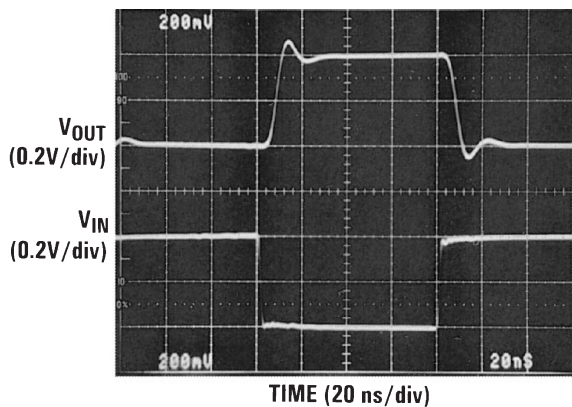

6b

01132821

**FIGURE 6. Resistive Isolation of  $C_L$  Provides Higher Fidelity Pulse Response.  $R_f$  and  $R_s$  Could Be Increased to Maintain  $A_v = -1$  and Improve Pulse Response Characteristics.**

### CAPACITIVE FEEDBACK

For voltage feedback amplifiers it is quite common to place a small lead compensation capacitor in parallel with feedback resistance,  $R_f$ . This compensation serves to reduce the amplifier's peaking in the frequency domain which equivalently tames the transient response. To limit the bandwidth of current feedback amplifiers, do not use a capacitor across  $R_f$ . The dynamic impedance of capacitors in the feedback loop reduces the amplifier's stability. Instead, reduced peaking in the frequency response, and bandwidth limiting can be accomplished by adding an RC circuit, as illustrated in Figure 7b.

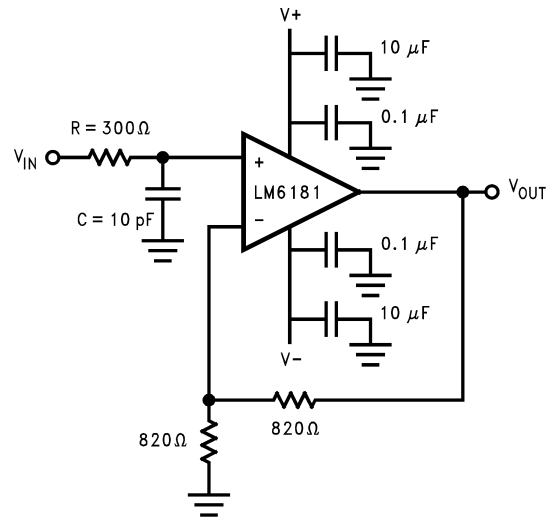

$$f_{-3\text{ dB}} = \frac{1}{2\pi RC}$$

7a

01132822

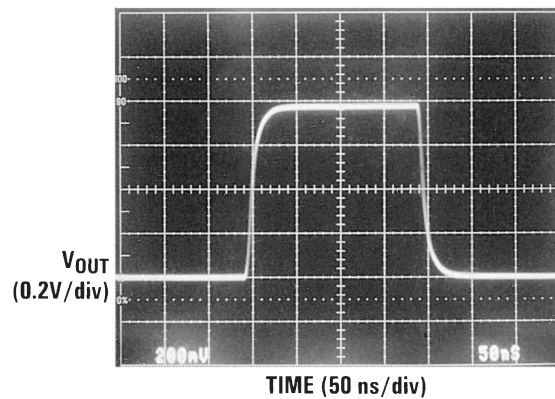

7b

01132823

**FIGURE 7. RC Limits Amplifier Bandwidth to 50 MHz, Eliminating Peaking in the Resulting Pulse Response**

## Typical Performance Characteristics

### OVERDRIVE RECOVERY

When the output or input voltage range of a high speed amplifier is exceeded, the amplifier must recover from an overdrive condition. The typical recovery times for open-loop, closed-loop, and input common-mode voltage range overdrive conditions are illustrated in Figures 9, 11, 11, 12 respectively.

The open-loop circuit of Figure 8 generates an overdrive response by allowing the  $\pm 0.5\text{V}$  input to exceed the linear input range of the amplifier. Typical positive and negative overdrive recovery times shown in Figure 9 are 5 ns and 25 ns, respectively.

Typical Performance Characteristics (Continued)

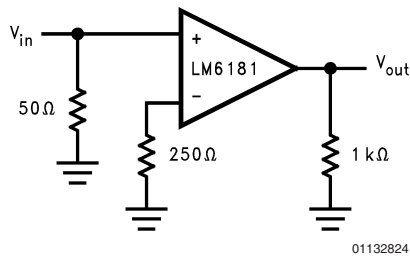

FIGURE 8.

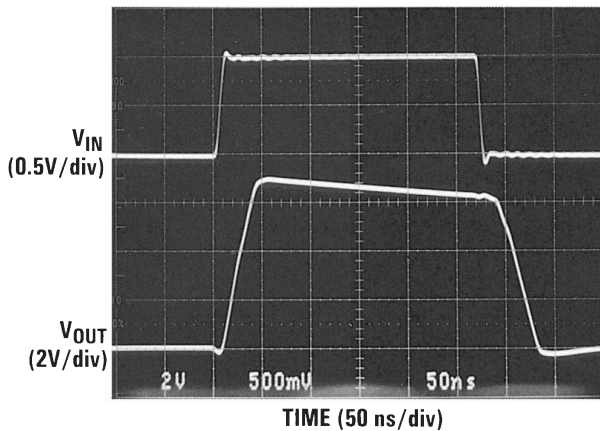

FIGURE 9. Open-Loop Overdrive Recovery Time of 5 ns, and 25 ns from Test Circuit in Figure 8

The large closed-loop gain configuration in Figure 10 forces the amplifier output into overdrive. Figure 11 displays the typical 30 ns recovery time to a linear output value.

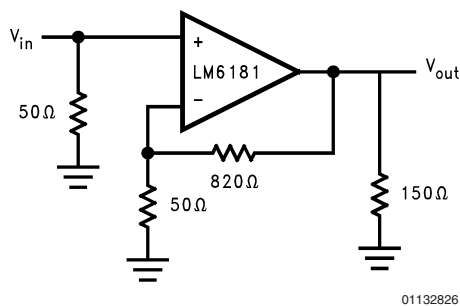

FIGURE 10.

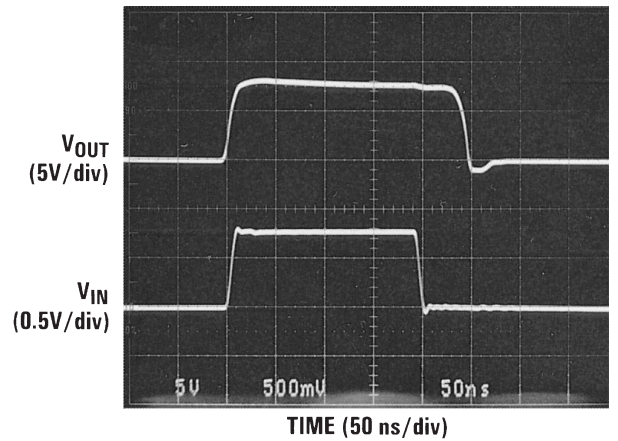

FIGURE 11. Closed-Loop Overdrive Recovery Time of 30 ns from Exceeding Output Voltage Range from Circuit in Figure 10

The common-mode input of the circuit in Figure 10 is exceeded by a 5V pulse resulting in a typical recovery time of 310 ns shown in Figure 12. The LM6181 supply voltage is  $\pm 5V$ .

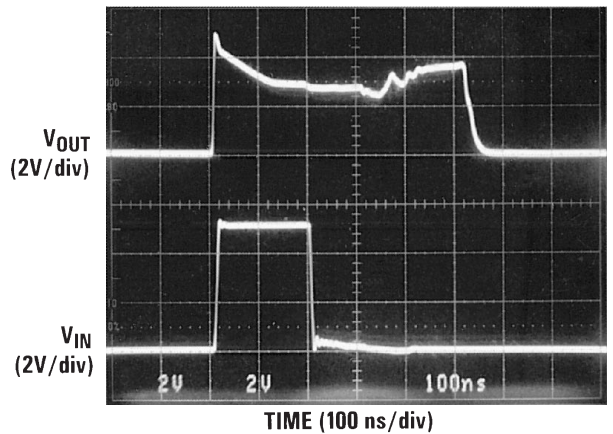
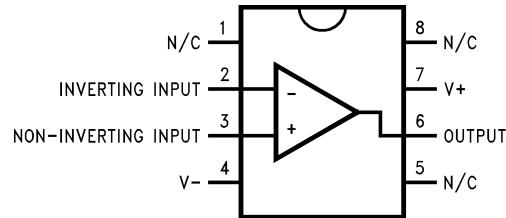

FIGURE 12. Exceptional Output Recovery from an Input that Exceeds the Common-Mode Range



## Connection Diagrams (For Ordering Information See Back Page)

### 8-Pin Dual-In-Line Package (N)/ Small Outline (M-8)



01132803

Order Number LM6181IN, LM6181AIN,  
LM6181AMN, LM6181AIM-8, LM6181IM-8  
or LM6181AMJ/883  
See NS Package Number J08A, M08A or N08E

### 16-Pin Small Outline Package (M)

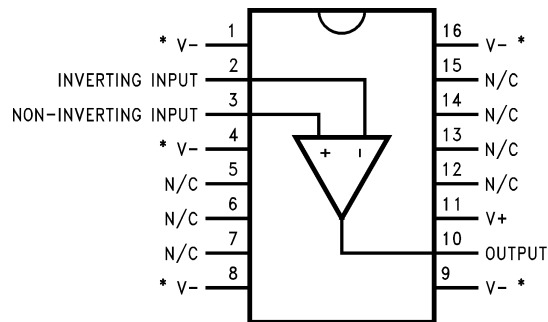

01132804

\*Heat sinking pins (Note 3)

Order Number LM6181IM or LM6181AIM  
See NS Package Number M16A

## Ordering Information

Package	Temperature Range		NSC Drawing
	Military -55°C to +125°C	Industrial -40°C to +85°C	
8-Pin Molded DIP	LM6181AMN	LM6181AIN LM6181IN	N08E
8-Pin Small Outline Molded Package		LM6181AIM-8 LM6181IM-8	M08A
16-Pin Small Outline		LM6181AIM LM6181IM	M16A
8-Pin Ceramic DIP	LM6181AMJ/883		J08A

# Physical Dimensions inches (millimeters)

unless otherwise noted

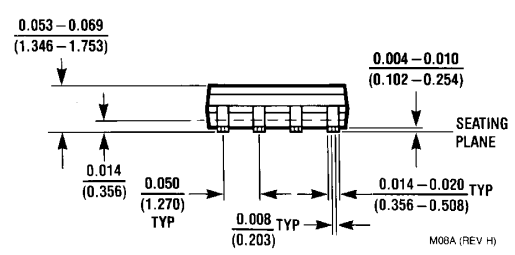
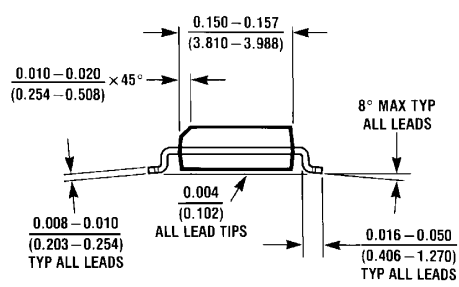
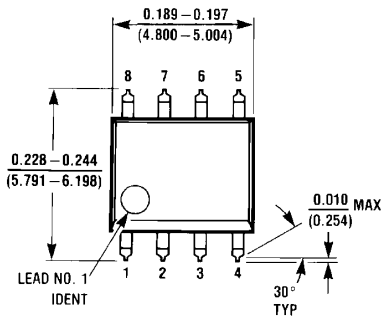

**8-Lead (0.150" Wide) Small Outline Molded Package (M-8)**  
**Order Number LM6181AIM-8 or LM6181IM-8**  
**NS Package Number M08A**

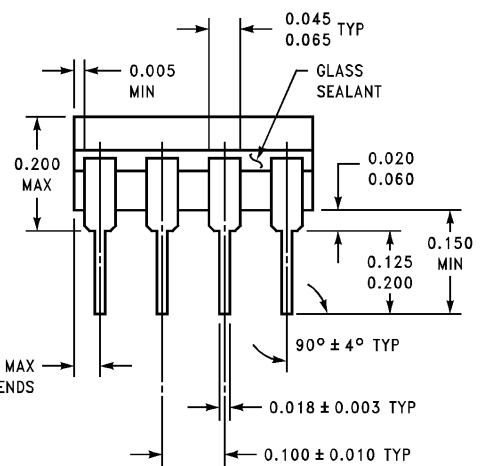
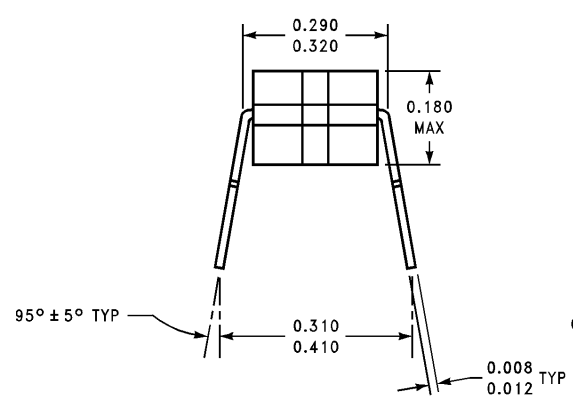
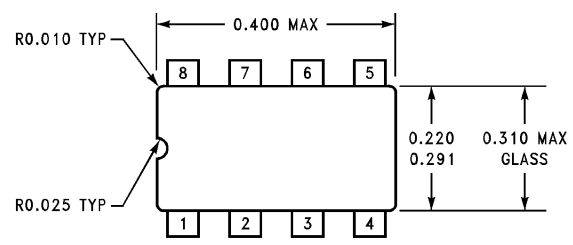

**8-Pin Ceramic Dual-In-Line Package**  
**Order Number LM6181AMJ/883**  
**NS Package Number J08A**

**Physical Dimensions** inches (millimeters) unless otherwise noted (Continued)

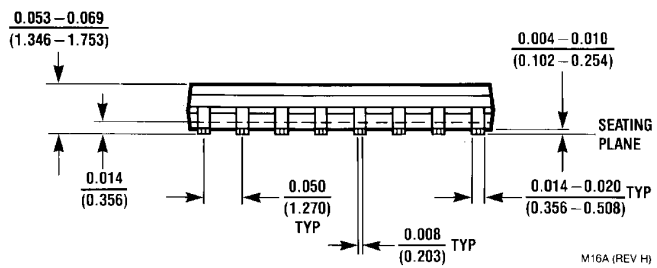
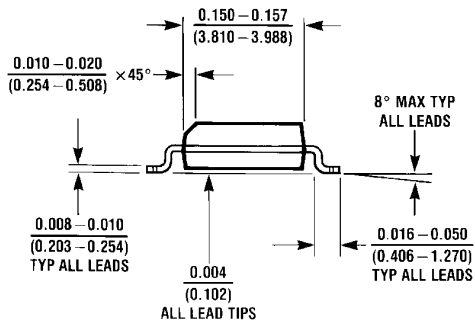
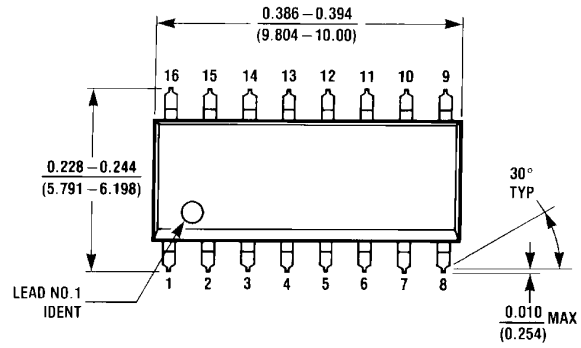

M16A (REV H)

**Small Outline Package (M)**  
**Order Number LM6181IM or LM6181AIM**  
**NS Package Number M16A**

**Physical Dimensions** inches (millimeters) unless otherwise noted (Continued)

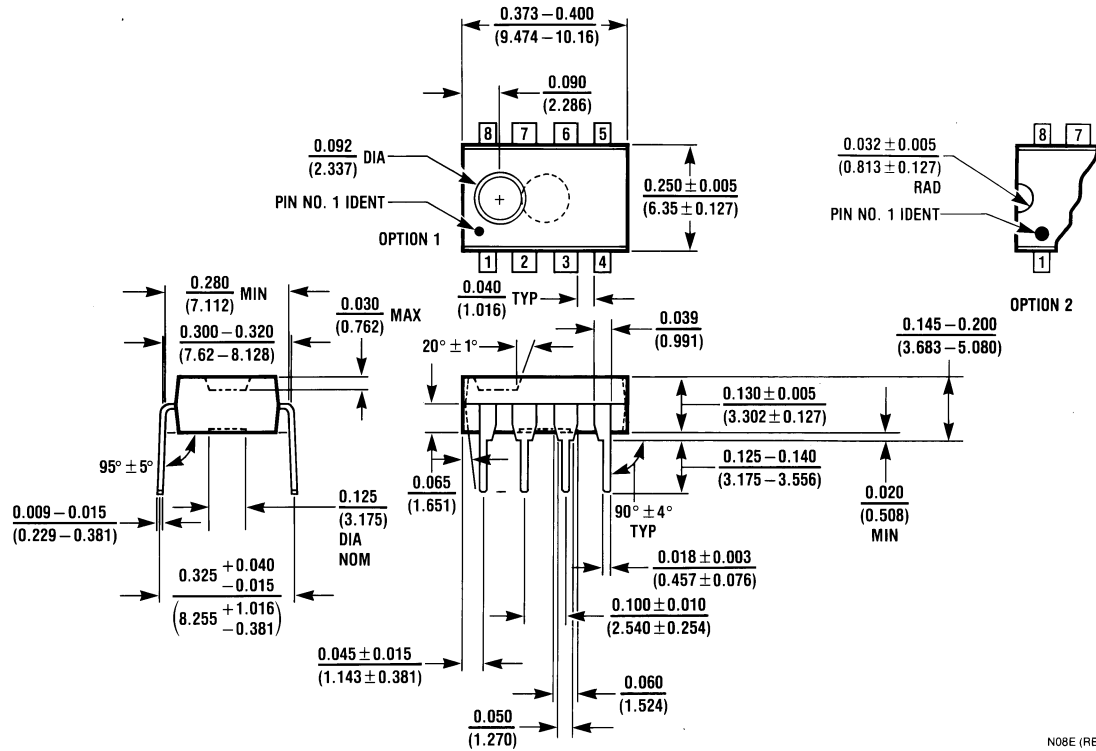

**Dual-In-Line-Package (N)**  
**Order Number LM6181AIN, LM6181IN or LM6181AMN**  
**NS Package Number N08E**

N08E (REV F)

National does not assume any responsibility for use of any circuitry described, no circuit patent licenses are implied and National reserves the right at any time without notice to change said circuitry and specifications.

For the most current product information visit us at [www.national.com](http://www.national.com).

**LIFE SUPPORT POLICY**

NATIONAL'S PRODUCTS ARE NOT AUTHORIZED FOR USE AS CRITICAL COMPONENTS IN LIFE SUPPORT DEVICES OR SYSTEMS WITHOUT THE EXPRESS WRITTEN APPROVAL OF THE PRESIDENT AND GENERAL COUNSEL OF NATIONAL SEMICONDUCTOR CORPORATION. As used herein:

1. Life support devices or systems are devices or systems which, (a) are intended for surgical implant into the body, or (b) support or sustain life, and whose failure to perform when properly used in accordance with instructions for use provided in the labeling, can be reasonably expected to result in a significant injury to the user.
2. A critical component is any component of a life support device or system whose failure to perform can be reasonably expected to cause the failure of the life support device or system, or to affect its safety or effectiveness.

**BANNED SUBSTANCE COMPLIANCE**

National Semiconductor certifies that the products and packing materials meet the provisions of the Customer Products Stewardship Specification (CSP-9-111C2) and the Banned Substances and Materials of Interest Specification (CSP-9-111S2) and contain no "Banned Substances" as defined in CSP-9-111S2.

 **National Semiconductor**  
**Americas Customer Support Center**  
 Email: [new.feedback@nsc.com](mailto:new.feedback@nsc.com)  
 Tel: 1-800-272-9959

**National Semiconductor**  
**Europe Customer Support Center**  
 Fax: +49 (0) 180-530 85 86  
 Email: [europe.support@nsc.com](mailto:europe.support@nsc.com)  
 Deutsch Tel: +49 (0) 69 9508 6208  
 English Tel: +44 (0) 870 24 0 2171  
 Français Tel: +33 (0) 1 41 91 8790

**National Semiconductor**  
**Asia Pacific Customer Support Center**  
 Email: [ap.support@nsc.com](mailto:ap.support@nsc.com)

**National Semiconductor**  
**Japan Customer Support Center**  
 Fax: 81-3-5639-7507  
 Email: [jpn.feedback@nsc.com](mailto:jpn.feedback@nsc.com)  
 Tel: 81-3-5639-7560

[www.national.com](http://www.national.com)