

## Dual audio and video line IPAD™, EMI filter and ESD protection

### Features

- High-density capacitor
- EMI low-pass filter and ESD protection
- High-efficiency in EMI filtering
- Lead-free package
- 400 µm pitch
- Very small PCB footprint: 0.77 mm x 1.17 mm
- Very thin package: 0.605 mm
- High reliability offered by monolithic integration
- Reduction of parasitic elements thanks to CSP integration

### Complies with the following standards

- IEC 61000-4-2 level 4 on external pin (A2, C2)
  - 15 kV (air discharge)
  - 8 kV (contact discharge)
- IEC 61000-4-2 level 1 on internal pin (A1, C1)
  - 2 kV (air discharge)
  - 2 kV (contact discharge)

### Application

- Dual audio and video line interface protection and filtering in mobile phones

### Description

The EMIF02-AV01F3 is a highly integrated array designed to suppress EMI / RFI noise and provide impedance matching for mobile phones and portable applications.

The EMIF02-AV01F3 is in Flip-Chip package to offer space saving and high RF performance.

Additionally, this low-pass filter includes an ESD protection circuitry to prevent damage to the application when subjected to ESD surges up to 15 kV.

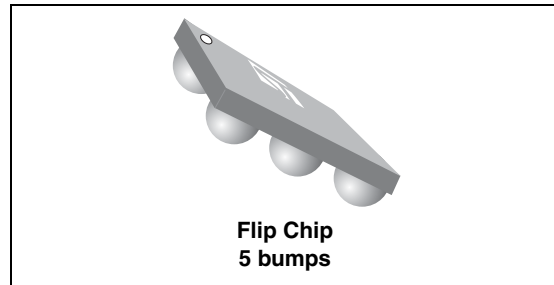

**Figure 1.** Pin configuration (bump side view)

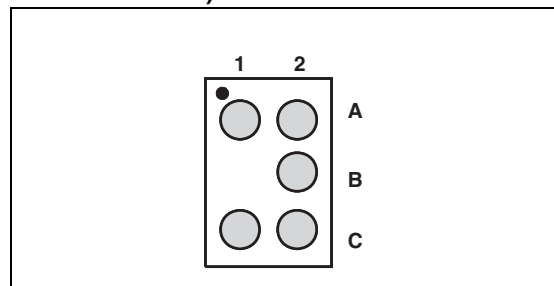

**Figure 2.** Schematic

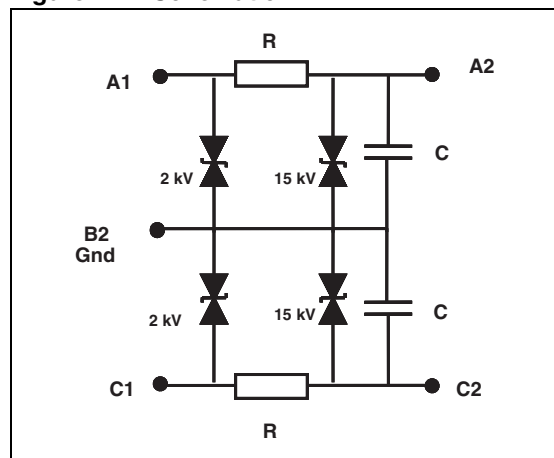

**TM:** IPAD is a trademark of STMicroelectronics.

# 1 Characteristics

**Table 1. Absolute maximum ratings ( $T_{amb} = 25\text{ }^{\circ}\text{C}$ )**

Symbol	Parameter	Value	Unit
$V_{pp}$	<b>Internal pins (A1, C1)</b>		
	ESD discharge IEC 61000-4-2, air discharge	2	kV
	ESD discharge IEC 61000-4-2, contact discharge	2	
	<b>External pins (A2, C2)</b>		
	ESD discharge IEC 61000-4-2, air discharge	15	
ESD discharge IEC 61000-4-2, contact discharge	8		
$T_j$	Maximum junction temperature	125	$^{\circ}\text{C}$
$P_{TOT}$	Total Power Dissipation	200	mW
$T_{op}$	Operating temperature range	- 40 to + 85	$^{\circ}\text{C}$
$T_{stg}$	Storage temperature range	- 55 to 150	$^{\circ}\text{C}$

**Figure 3. Electrical characteristics (definitions)**

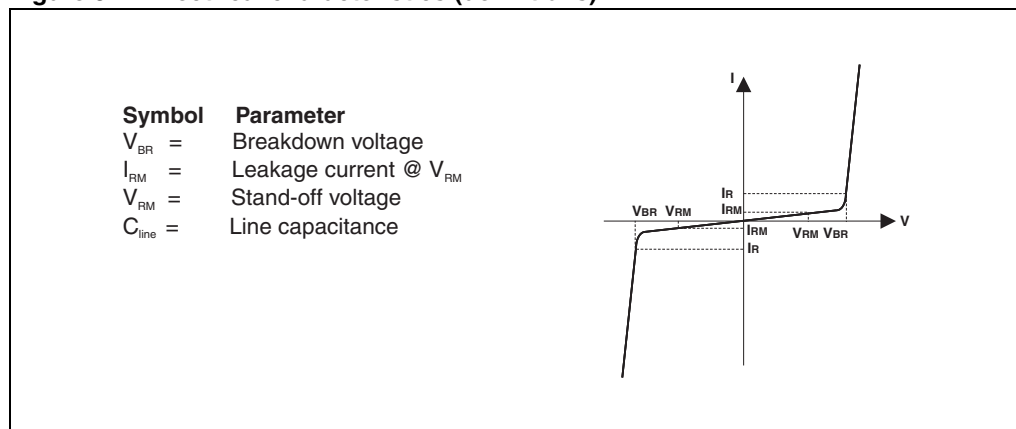

**Table 2. Electrical characteristics (values,  $T_{amb} = 25\text{ }^{\circ}\text{C}$ )**

Symbol	Test conditions	Min.	Typ.	Max.	Unit
$V_{BR}$	$I_R = 1\text{ mA}$	14		18	V
$I_{RM}$	$V_{RM} = 3\text{ V per line}$			0.5	$\mu\text{A}$
$R_{I/O}$		12	15	18	$\Omega$
$C_{line}$	$V_{line} = 0\text{ V}, V_{osc} = 30\text{ mV}, F = 100\text{ kHz}$	2.56	3.2	3.84	nF

Figure 4. Attenuation simulation with 1 kΩ input and 10 kΩ output

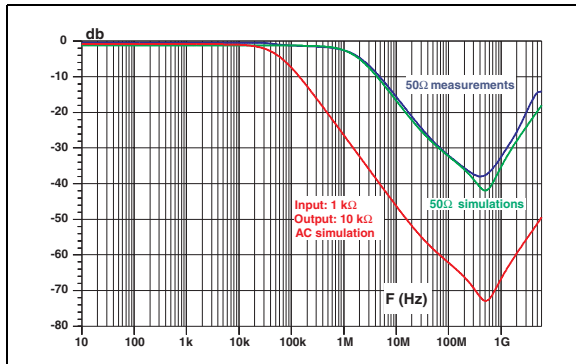

Figure 5. Analog crosstalk

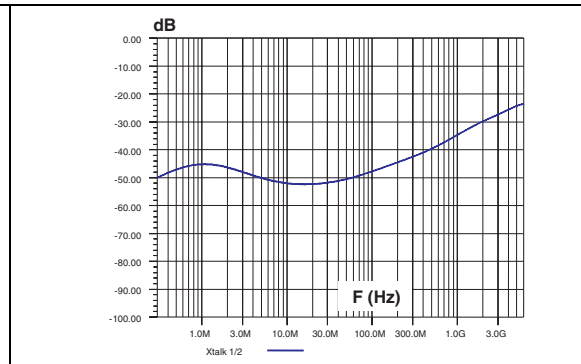

Figure 6. Digital crosstalk

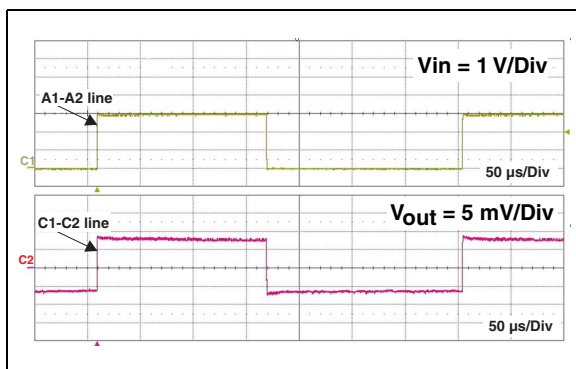

Figure 7. ESD response to IEC 61000-4-2 (+15 kV air discharge) on one input (VIN) and one output (VOUT)

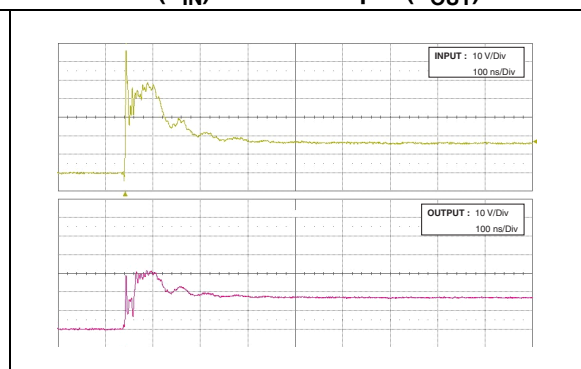

Figure 8. ESD response to IEC 61000-4-2 (-15 kV air discharge) on one input (VIN) and one output (VOUT)

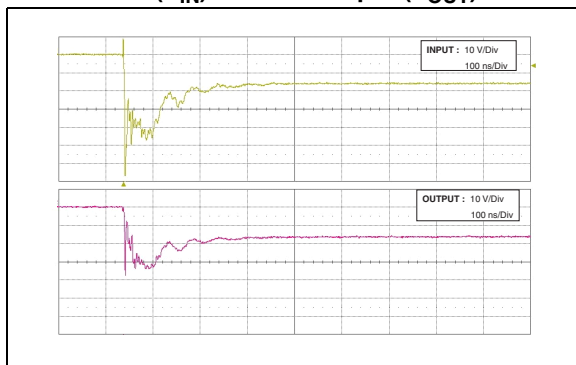
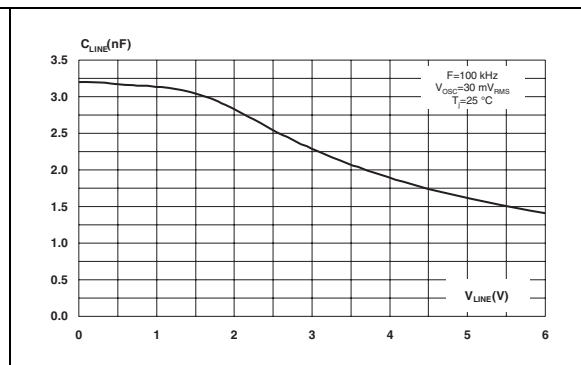
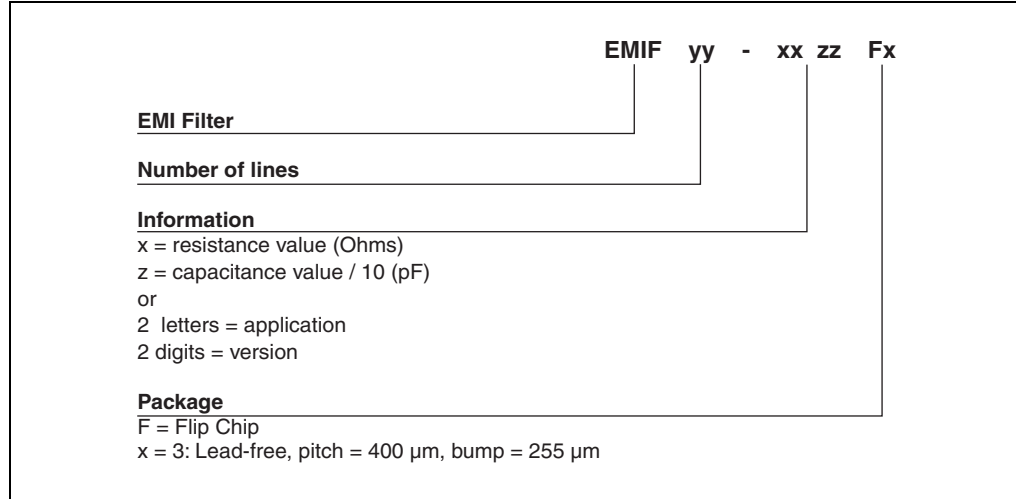

Figure 9. Line capacitance versus applied voltage



## 2 Ordering information scheme

Figure 10. Ordering information scheme



## 3 Package information

In order to meet environmental requirements, ST offers these devices in different grades of ECOPACK® packages, depending on their level of environmental compliance. ECOPACK® specifications, grade definitions and product status are available at: [www.st.com](http://www.st.com). ECOPACK® is an ST trademark.

Figure 11. Package dimensions

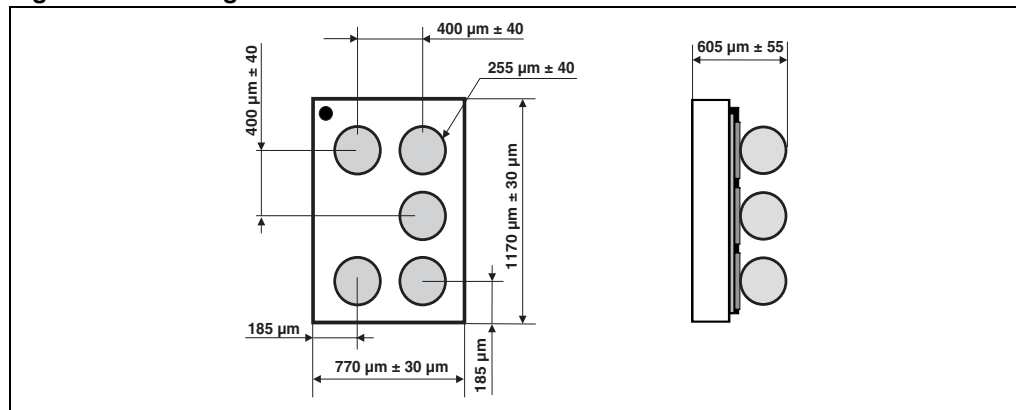

Figure 12. Footprint

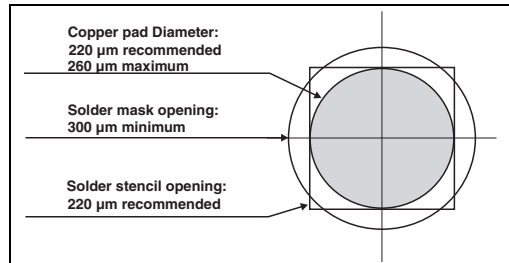

Figure 13. Marking

Dot  
xx = marking  
z = manufacturing location  
yww = datecode  
(y = year  
ww = week)

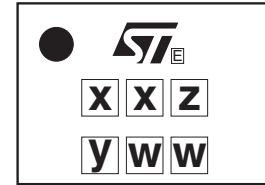
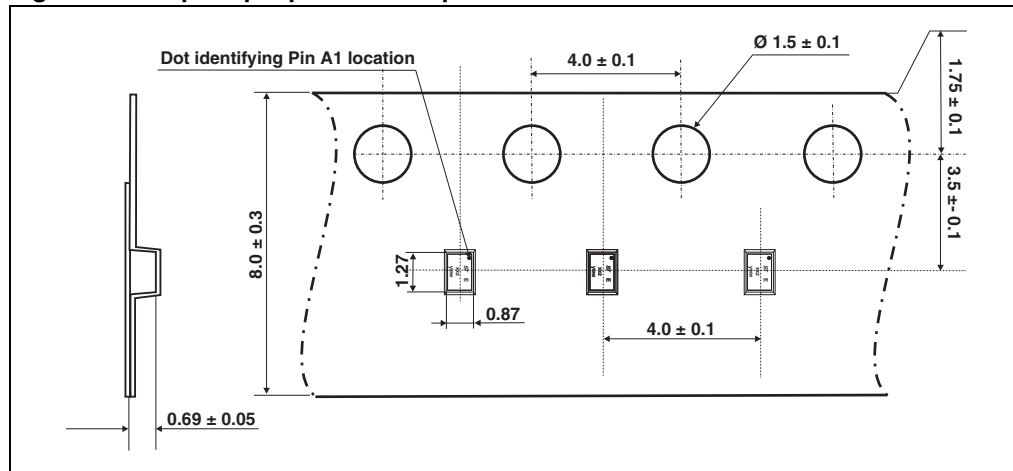

Figure 14. Flip Chip tape and reel specification



Note:

Note: More information is available in the application note:

AN2348: "Flip Chip: Package description and recommendations for use"

AN1751: "EMI filters: Recommendations and measurements"

## 4 Ordering information

Table 3. Ordering information

Order code	Marking	Package	Weight	Base qty	Delivery mode
EIMF02-AV01F3	HH	Flip Chip	1.4 mg	5000	Tape and reel 7"

## 5 Revision history

Table 4. Document revision history

Date	Revision	Changes
06-Oct-2006	1	Initial release.
11-Oct-2006	2	Corrected test conditions for $C_{line}$ in Table 2.
17-Apr-2008	3	Updated ECOPACK statement. Updated <a href="#">Figure 10</a> , <a href="#">Figure 11</a> and <a href="#">Figure 14</a> . Reformatted to current standards.
08-Apr-2010	4	Updated dimensions on page 1 and <a href="#">Figure 4</a> , <a href="#">Figure 11</a> , <a href="#">Figure 14</a> .

**Please Read Carefully:**

Information in this document is provided solely in connection with ST products. STMicroelectronics NV and its subsidiaries ("ST") reserve the right to make changes, corrections, modifications or improvements, to this document, and the products and services described herein at any time, without notice.

All ST products are sold pursuant to ST's terms and conditions of sale.

Purchasers are solely responsible for the choice, selection and use of the ST products and services described herein, and ST assumes no liability whatsoever relating to the choice, selection or use of the ST products and services described herein.

No license, express or implied, by estoppel or otherwise, to any intellectual property rights is granted under this document. If any part of this document refers to any third party products or services it shall not be deemed a license grant by ST for the use of such third party products or services, or any intellectual property contained therein or considered as a warranty covering the use in any manner whatsoever of such third party products or services or any intellectual property contained therein.

**UNLESS OTHERWISE SET FORTH IN ST'S TERMS AND CONDITIONS OF SALE ST DISCLAIMS ANY EXPRESS OR IMPLIED WARRANTY WITH RESPECT TO THE USE AND/OR SALE OF ST PRODUCTS INCLUDING WITHOUT LIMITATION IMPLIED WARRANTIES OF MERCHANTABILITY, FITNESS FOR A PARTICULAR PURPOSE (AND THEIR EQUIVALENTS UNDER THE LAWS OF ANY JURISDICTION), OR INFRINGEMENT OF ANY PATENT, COPYRIGHT OR OTHER INTELLECTUAL PROPERTY RIGHT.**

**UNLESS EXPRESSLY APPROVED IN WRITING BY AN AUTHORIZED ST REPRESENTATIVE, ST PRODUCTS ARE NOT RECOMMENDED, AUTHORIZED OR WARRANTED FOR USE IN MILITARY, AIR CRAFT, SPACE, LIFE SAVING, OR LIFE SUSTAINING APPLICATIONS, NOR IN PRODUCTS OR SYSTEMS WHERE FAILURE OR MALFUNCTION MAY RESULT IN PERSONAL INJURY, DEATH, OR SEVERE PROPERTY OR ENVIRONMENTAL DAMAGE. ST PRODUCTS WHICH ARE NOT SPECIFIED AS "AUTOMOTIVE GRADE" MAY ONLY BE USED IN AUTOMOTIVE APPLICATIONS AT USER'S OWN RISK.**

Resale of ST products with provisions different from the statements and/or technical features set forth in this document shall immediately void any warranty granted by ST for the ST product or service described herein and shall not create or extend in any manner whatsoever, any liability of ST.

ST and the ST logo are trademarks or registered trademarks of ST in various countries.

Information in this document supersedes and replaces all information previously supplied.

The ST logo is a registered trademark of STMicroelectronics. All other names are the property of their respective owners.

© 2010 STMicroelectronics - All rights reserved

STMicroelectronics group of companies

Australia - Belgium - Brazil - Canada - China - Czech Republic - Finland - France - Germany - Hong Kong - India - Israel - Italy - Japan - Malaysia - Malta - Morocco - Philippines - Singapore - Spain - Sweden - Switzerland - United Kingdom - United States of America

[www.st.com](http://www.st.com)

