

FEATURES

- **2 CHANNEL TYPE:**
1a + 1b output
- **LOW LED OPERATING CURRENT:**
 $I_F = 2 \text{ mA}$
- **DESIGNED FOR AC/DC SWITCHING LINE CHANGER**
- **SMALL PACKAGE:**
8 Pin DIP
- **LOW OFFSET VOLTAGE**
- **SURFACE MOUNT TYPE LEAD AVAILABLE:**
PS7142L-1C

DESCRIPTION

PS7142-1C and PS7142L-1C are transfer type solid state relays containing normally open (N.O.) contacts and normally closed contacts on the output side.

They are suitable for analog signal control because of their low offset and high linearity.

APPLICATIONS

- EXCHANGE EQUIPMENT
- MEASUREMENT EQUIPMENT
- FA/OA EQUIPMENT

ELECTRICAL CHARACTERISTICS (T_A = 25°C)

PART NUMBER				PS7142-1C, PS7142L-1C		
SYMBOLS		PARAMETERS	UNITS	MIN	TYP	MAX
Diode	V _F	Forward Voltage, I _F = 10 mA	V		1.2	1.4
	I _R	Reverse Current, V _R = 5 V	μA			5.0
MOSFET	I _{Loff}	Off-State Leakage Current, N.O.: I _F = 0 mA, V _D = 400 V N.C.: I _F = 10 mA, V _D = 400 V	μA		0.03	1.0
	C _{OUT}	Output Capacitance, N.O.: V _D = 0 V, f = 1 MHz N.C.: I _F = 10 mA, V _D = 0 V, f = 1 MHz	pF/ch		140	430
Coupled	I _{Fon}	LED On-state Current, N.O.: I _L = 200 mA	mA			2.0
	I _{Foff}	LED Off-state Current, N.C.: I _L = 200 mA	mA			2.0
	R _{on1}	On-State Resistance, N.O.: I _F = 10 mA, I _L = 10 mA N.C.: I _F = 0 mA, I _L = 10 mA	Ω		8	12
					7	12
	R _{on2}	On-State Resistance, N.O.: I _F = 10 mA, I _L = 200 mA, t ≤ 10 ms N.C.: I _F = 0 mA, I _L = 200 mA, t ≤ 10 ms	Ω		7	10
					7	10
	t _{on} (N.O.)	Turn-On Time ¹ , I _F = 10 mA, V _O = 5 V, PW ≥ 10 ms	ms		0.3	2.0
	t _{on} (N.C.)				0.03	0.2
	t _{off} (N.O.)	Turn-Off Time ¹ , I _F = 10 mA, V _O = 5 V, PW ≥ 10 ms	ms		0.03	0.2
t _{off} (N.C.)				0.6	2.0	
R _{I-O}	Isolation Resistance, V _{in-out} = 1.0 kVDC	Ω	10 ⁹			
C _{I-O}	Isolation Capacitance, V = 0 V, f = 1 MHz	pF/ch		1.1		

Note:

1. Test circuit for Switching Time

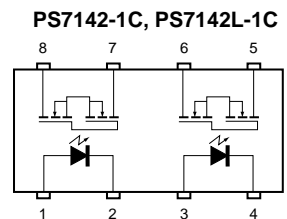
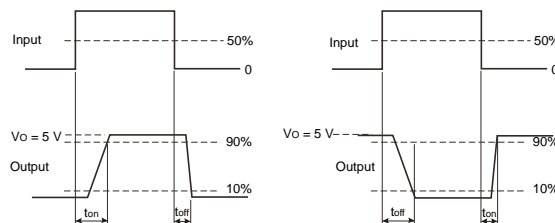
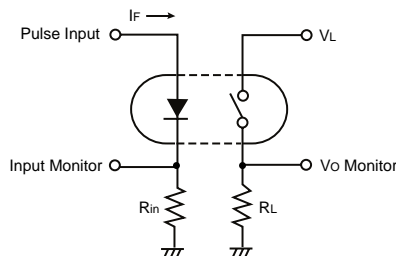

PS7142-1C, PS7142L-1C

ABSOLUTE MAXIMUM RATINGS¹ (T_A = 25°C)

SYMBOLS	PARAMETERS	UNITS	RATINGS	
Diode	V _R	Reverse Voltage	V	5
	I _F	Forward Current (DC)	mA	50
	P _D	Power Dissipation	mW/ch	50
	I _{FP}	Peak Forward Current ²	A	1
MOSFET	V _L	Break Down Voltage	V	400
	I _L	Continuous Load Current	mA	200
	I _{LP}	Pulse Load Current ³ (AC/DC Connection)	mA	400
	P _D	Power Dissipation	mW/ch	375
	BV	Isolation Voltage ⁴	Vr.m.s.	1500
P _T	Total Power Dissipation	mW	850	
T _A	Operating Ambient Temp.	°C	-40 to +80	
T _{STG}	Storage Temperature	°C	-40 to +100	

Notes:

1. Operation in excess of any one of these parameters may result in permanent damage.
2. PW = 100 μs, Duty Cycle = 1%
3. PW = 100 ms, 1 shot.
4. AC voltage for 1 minute at T_A = 25 °C, RH = 60% between input and output.

TYPICAL PERFORMANCE CURVES (T_A = 25 °C)

MAXIMUM FORWARD CURRENT vs. AMBIENT TEMPERATURE

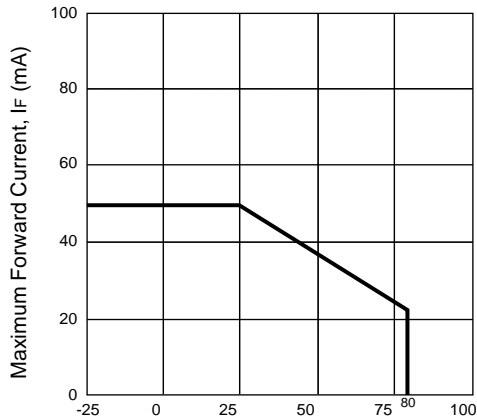

Ambient Temperature, T_A (°C)

MAXIMUM LOAD CURRENT vs. AMBIENT TEMPERATURE

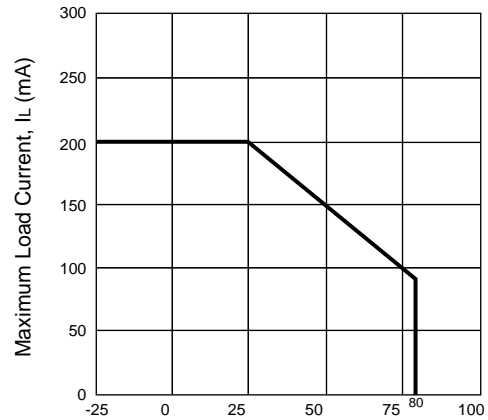

Ambient Temperature, T_A (°C)

FORWARD VOLTAGE vs. AMBIENT TEMPERATURE

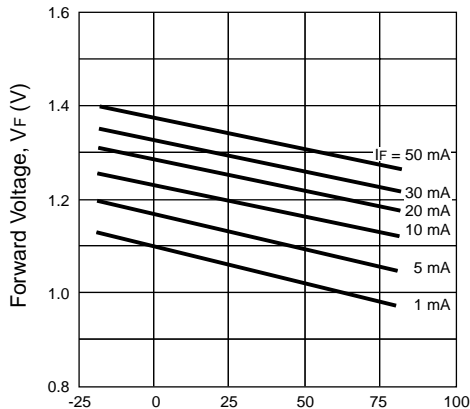

Ambient Temperature, T_A (°C)

OUTPUT CAPACITANCE vs. APPLIED VOLTAGE

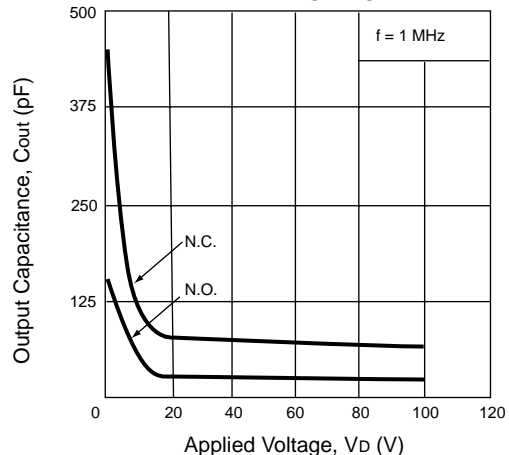

Applied Voltage, V_D (V)

RECOMMENDED OPERATING CONDITIONS (T_A = 25 °C)

SYMBOL	PARAMETER	UNITS	MIN	TYP	MAX
I _F	LED Operating Current	mA	2	10	20
V _F	LED Off Voltage	V	0		0.5

ORDERING INFORMATION

PART NUMBER	PACKAGE	PACKING STYLE
PS7142-1C	8 Pin DIP	Magazine case, 50 pcs
PS7142L-1C		Embossed Tape, 1000 pcs/reel
PS7142L-1C-E3		
PS7142L-1C-E4		

TYPICAL PERFORMANCE CURVES ($T_A = 25^\circ\text{C}$)

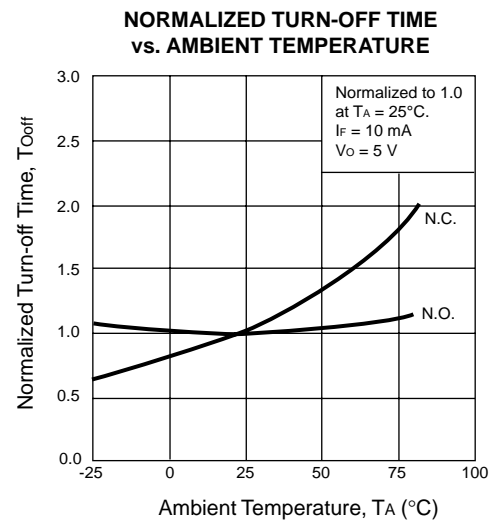
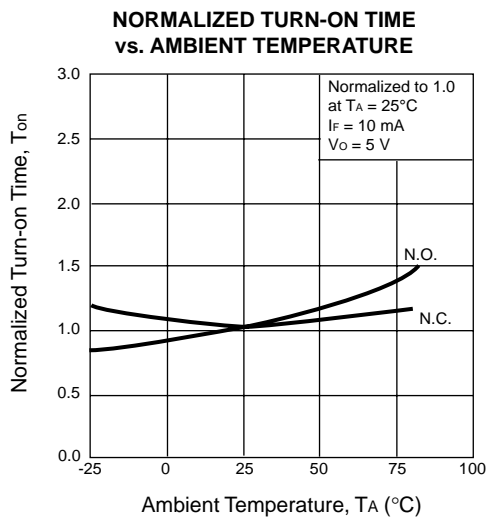
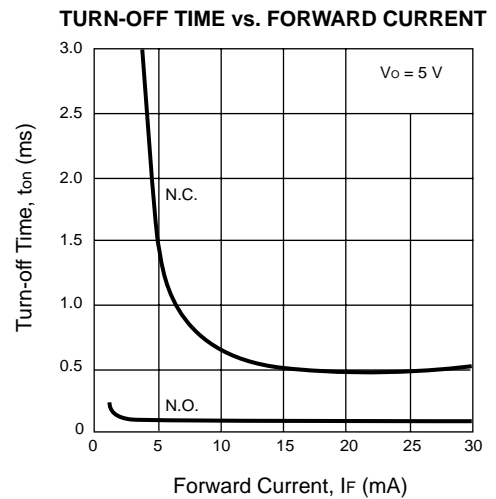
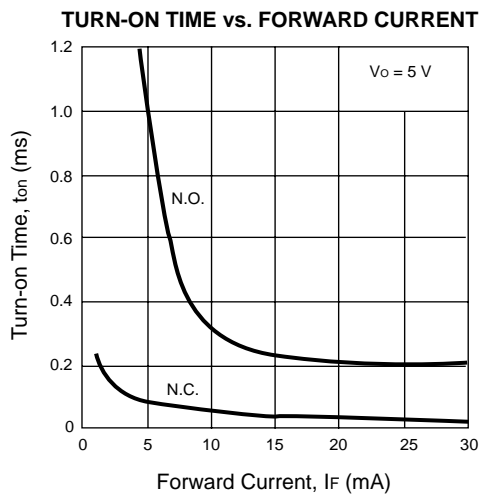
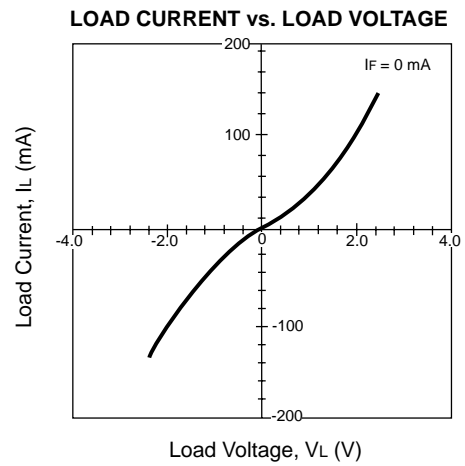
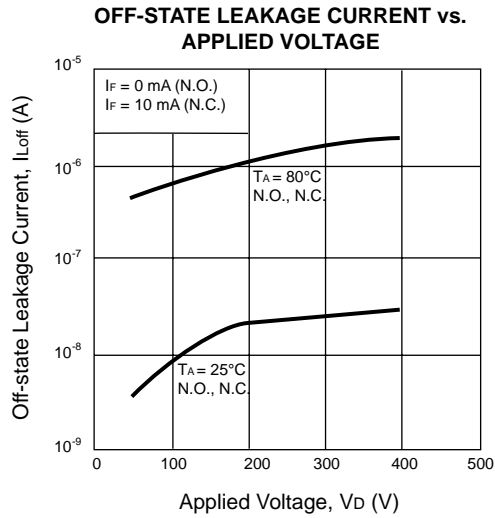

TYPICAL PERFORMANCE CURVES (TA = 25 °C)

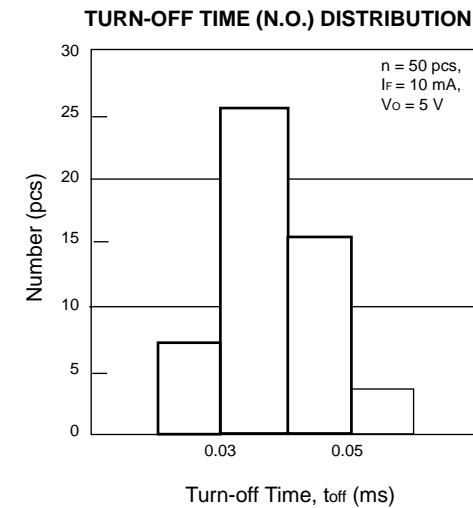
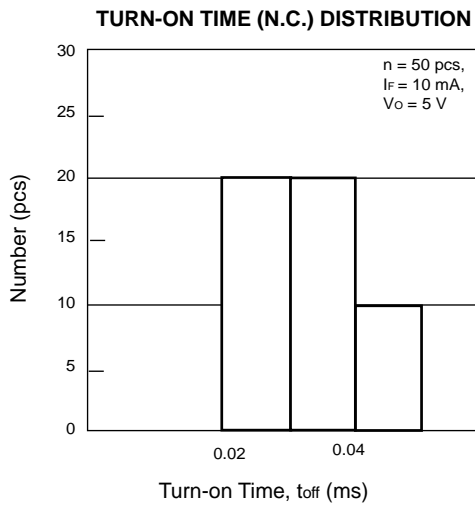
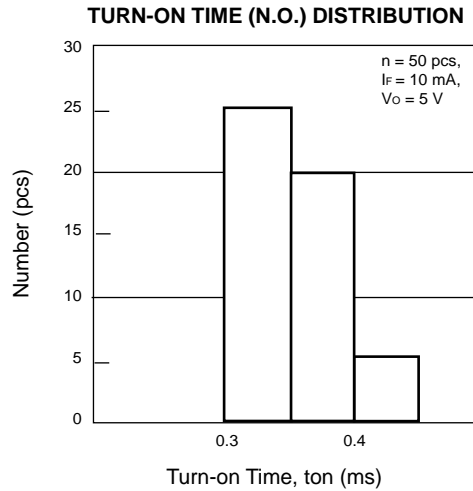
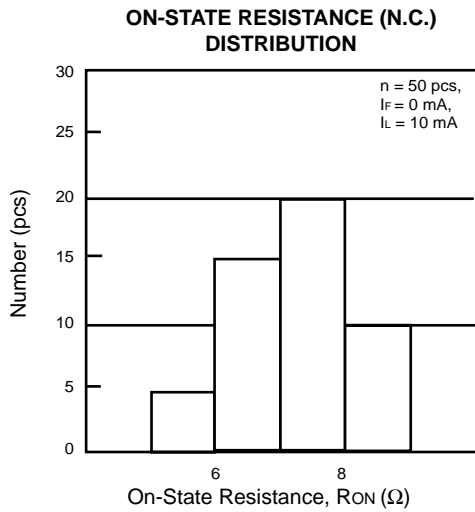
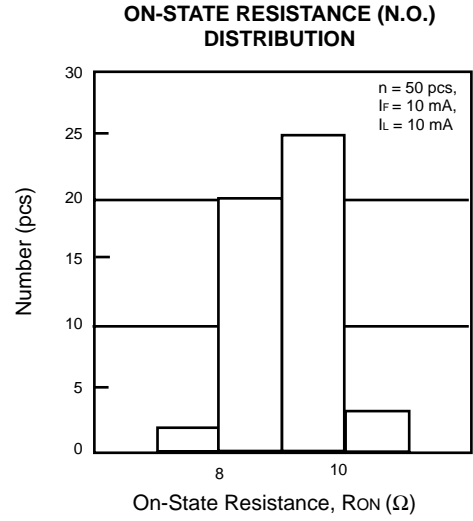
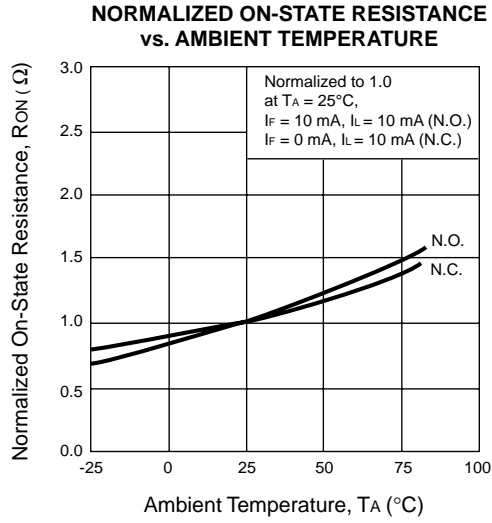

TYPICAL PERFORMANCE CURVES ($T_A = 25\text{ }^\circ\text{C}$)

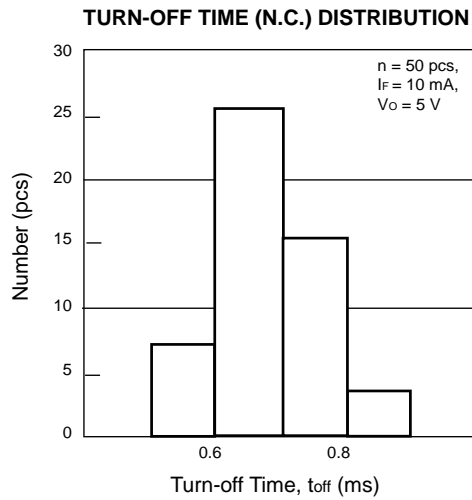

OUTLINE DIMENSIONS (Units in mm)

PS7142-1C

(TOP VIEW)

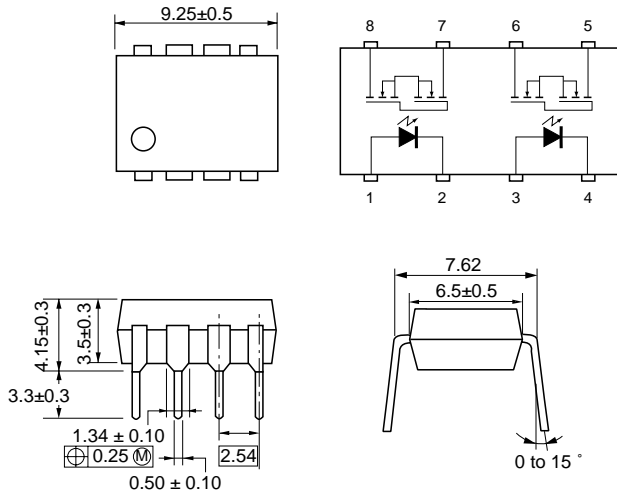

1. LED Anode
2. LED Cathode
3. LED Anode
4. LED Cathode
5. MOSFET (N.O.)
6. MOSFET (N.O.)
7. MOSFET (N.C.)
8. MOSFET (N.C.)

PS7142L-1C

(TOP VIEW)

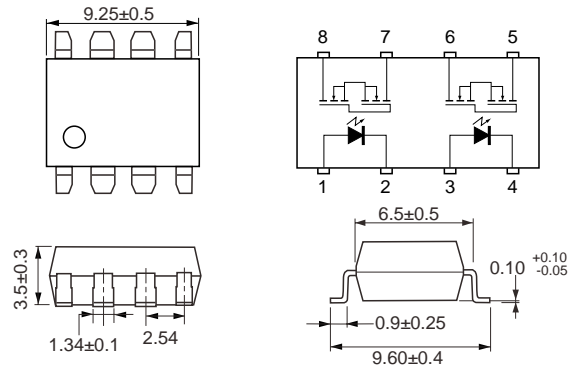

1. LED Anode
2. LED Cathode
3. LED Anode
4. LED Cathode
5. MOSFET (N.O.)
6. MOSFET (N.O.)
7. MOSFET (N.C.)
8. MOSFET (N.C.)

TAPING SPECIFICATIONS (Units in mm)

OUTLINE AND DIMENSIONS (TAPE)

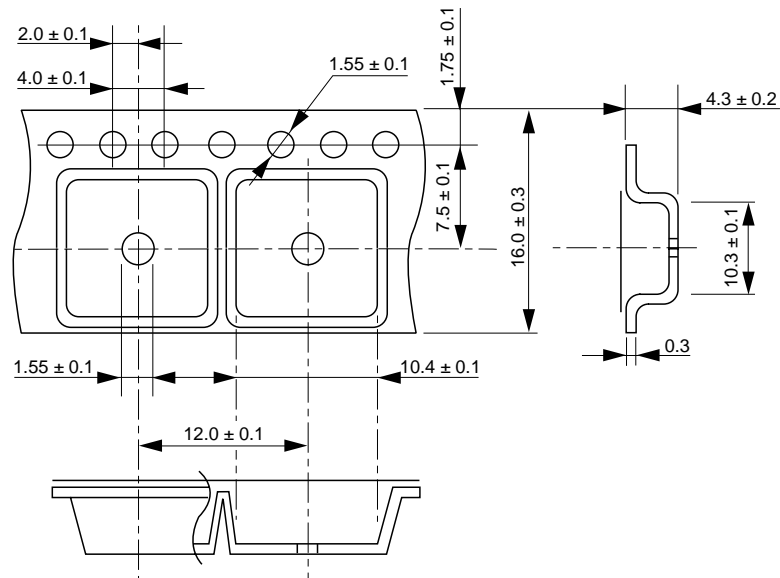

TAPING DIRECTION

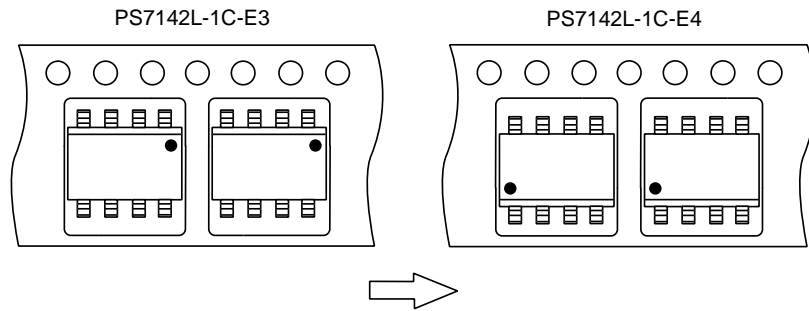

OUTLINE AND DIMENSIONS (REEL)

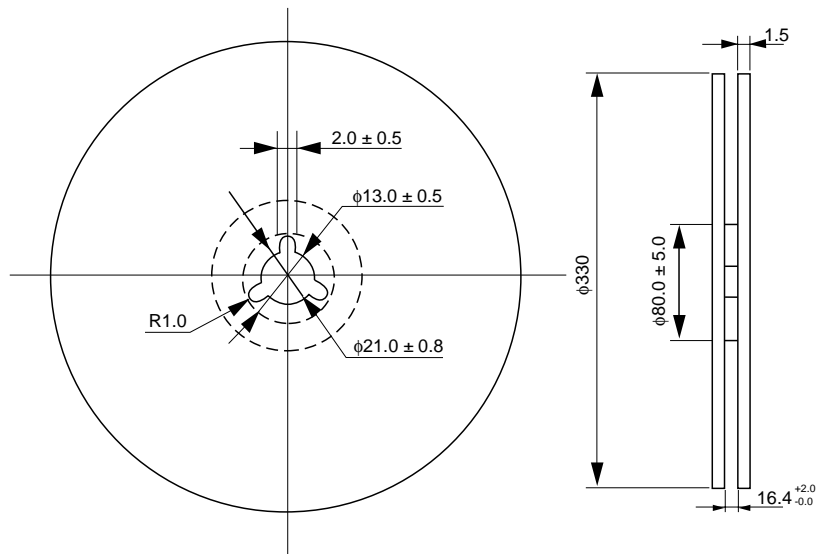

Packing : 1000 pcs/reel

RECOMMENDED SOLDERING CONDITIONS

(1) Infrared reflow soldering

- Peak reflow temperature 235 °C or below (package surface temperature)
- Time of temperature higher than 210 °C 30 seconds or less
- Number of reflows Two
- Flux Rosin flux containing small amount of chlorine
(The flux with a maximum chlorine content of 0.2 Wt % is recommended.)

Recommended Temperature Profile of Infrared Reflow

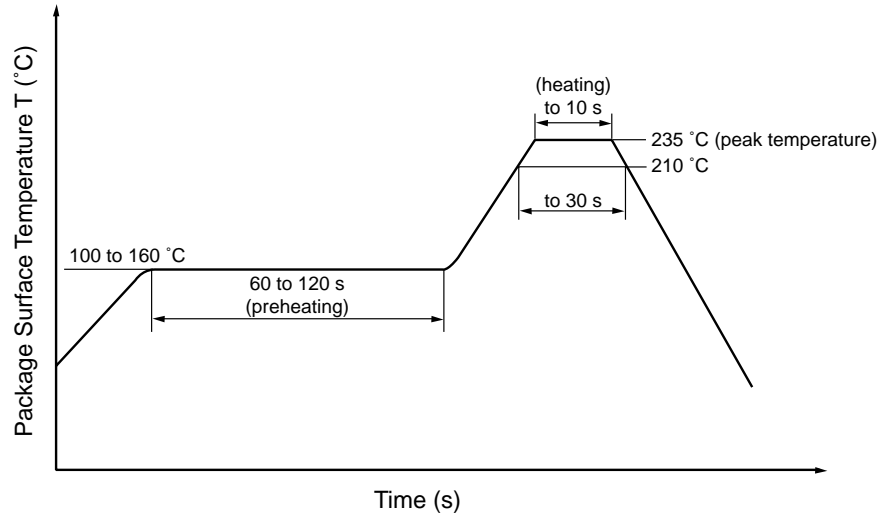

(2) Dip soldering

- Temperature 260 °C or below (molten solder temperature)
- Time 10 seconds or less
- Number of times One
- Flux Rosin flux containing small amount of chlorine
(The flux with a maximum chlorine content of 0.2 Wt % is recommended.)

(3) Cautions

- Fluxes
Avoid removing the residual flux with freon-based cleaning solvent.

EXCLUSIVE NORTH AMERICAN AGENT FOR **NEC** RF, MICROWAVE & OPTOELECTRONIC SEMICONDUCTORS

CEL CALIFORNIA EASTERN LABORATORIES • Headquarters • 4590 Patrick Henry Drive • Santa Clara, CA 95054-1817 • (408) 988-3500 • Telex 34-6393 • FAX (408) 988-0279
24-Hour Fax-On-Demand: 800-390-3232 (U.S. and Canada only) • Internet: <http://WWW.CEL.COM>

DATA SUBJECT TO CHANGE WITHOUT NOTICE

07/27/2001