



Solid State Relay  
OCMOS FET

# PS7141-1B,-2B,PS7141L-1B,-2B

6, 8-PIN DIP, 400 V BREAK DOWN VOLTAGE, NORMALLY CLOSE TYPE  
1-ch, 2-ch Optical Coupled MOS FET

## DESCRIPTION

The PS7141-1B, -2B and PS7141L-1B, -2B are solid state relays containing GaAs LEDs on the light emitting side (input side) and normally close (N.C.) contact MOS FETs on the output side.

They are suitable for analog signal control because of their low offset and high linearity.

The PS7141L-1B, -2B have a surface mount type lead.

## FEATURES

- 1 channel type (1 b output) or 2 channel type (1 b + 1 b output)
- Low LED operating current ( $I_F = 2 \text{ mA}$ )
- Designed for AC/DC switching line changer
- Small package (6, 8-pin DIP)
- Low offset voltage
- PS7141L-1B, -2B: Surface mount type
- UL approved: File No. E72422 (S) (PS7141-1B, PS7141L-1B only)
- BSI approved: No. 8245/8246
- CSA approved: No. CA 101391

## APPLICATIONS

- Exchange equipment
- Measurement equipment
- FA/OA equipment

The information in this document is subject to change without notice. Before using this document, please confirm that this is the latest version.

PACKAGE DIMENSIONS (in millimeters)

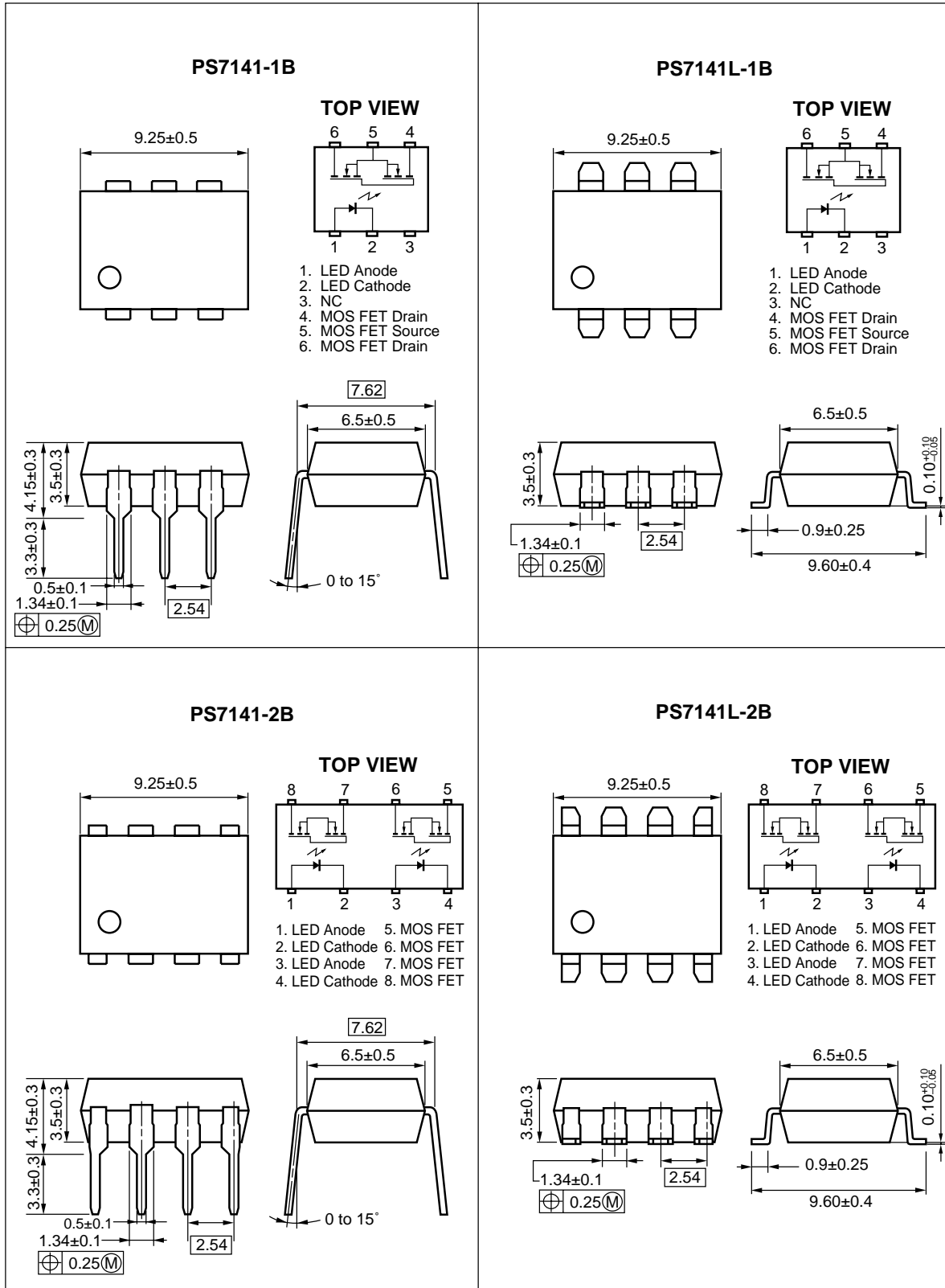

**ORDERING INFORMATION (Solder Contains Lead)**

Part Number	Package	Packing Style	Application Part Number**1
PS7141-1B	6-pin DIP	Magazine case 50 pcs	PS7141-1B
PS7141L-1B			PS7141L-1B
PS7141L-1B-E3		Embossed Tape 1 000 pcs/reel	
PS7141L-1B-E4			
PS7141-2B	8-pin DIP	Magazine case 50 pcs	PS7141-2B
PS7141L-2B			PS7141L-2B
PS7141L-2B-E3		Embossed Tape 1 000 pcs/reel	
PS7141L-2B-E4			

\*1 For the application of the Safety Standard, following part number should be used.

**ORDERING INFORMATION (Pb-Free)**

Part Number	Package	Packing Style	Application Part Number**1
PS7141-1B-A	6-pin DIP	Magazine case 50 pcs	PS7141-1B
PS7141L-1B-A			PS7141L-1B
PS7141L-1B-E3-A		Embossed Tape 1 000 pcs/reel	
PS7141L-1B-E4-A			
PS7141-2B-A	8-pin DIP	Magazine case 50 pcs	PS7141-2B
PS7141L-2B-A			PS7141L-2B
PS7141L-2B-E3-A		Embossed Tape 1 000 pcs/reel	
PS7141L-2B-E4-A			

\*1 For the application of the Safety Standard, following part number should be used.

**ABSOLUTE MAXIMUM RATINGS (T<sub>A</sub> = 25 °C, unless otherwise specified)**

Parameter		Symbol	Ratings		Unit
			PS7141-1B, PS7141L-1B	PS7141-2B, PS7141L-2B	
Diode	Forward Current (DC)	I <sub>F</sub>	50		mA
	Reverse Voltage	V <sub>R</sub>	5.0		V
	Power Dissipation	P <sub>D</sub>	50		mW/ch
	Peak Forward Current <sup>*1</sup>	I <sub>FP</sub>	1		A
MOS FET	Break Down Voltage	V <sub>L</sub>	400		V
	Continuous Load Current <sup>*2</sup>	Connection A	150		mA
		Connection B	200	–	
		Connection C	300	–	
	Pulse Load Current <sup>*3</sup> (AC/DC Connection)	I <sub>LP</sub>	300		mA
Power Dissipation	P <sub>D</sub>	560	375	mW/ch	
Isolation Voltage <sup>*4</sup>		BV	1 500		Vr.m.s.
Total Power Dissipation		P <sub>T</sub>	610	850	mW
★	Operating Ambient Temperature	T <sub>A</sub>	–40 to +85		°C
	Storage Temperature	T <sub>stg</sub>	–40 to +100		°C

\*1 PW = 100 μs, Duty Cycle = 1 %

\*2 Conditions: I<sub>F</sub> ≥ 2 mA. The following types of load connections are available.

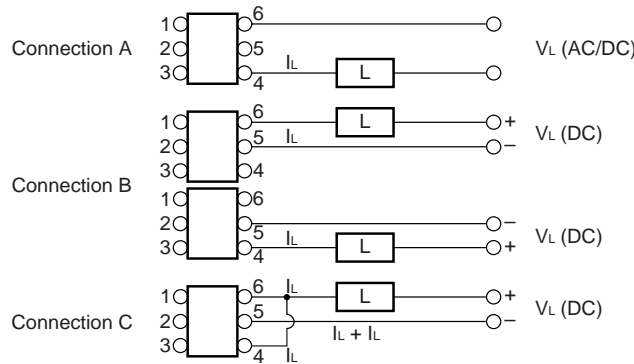

\*3 PW = 100 ms, 1 shot

\*4 AC voltage for 1 minute at T<sub>A</sub> = 25 °C, RH = 60 % between input and output

**RECOMMENDED OPERATING CONDITIONS (TA = 25 °C)**

Parameter	Symbol	MIN.	TYP.	MAX.	Unit
LED Operating Current	IF	2	10	20	mA
LED Off Voltage	VF	0		0.5	V

★ **ELECTRICAL CHARACTERISTICS (TA = 25 °C)**

Parameter		Symbol	Conditions		MIN.	TYP.	MAX.	Unit
			PS7141-1B, PS7141L-1B	PS7141-2B, PS7141L-2B				
Diode	Forward Voltage	VF	IF = 10 mA			1.2	1.4	V
	Reverse Current	IR	VR = 5 V				5.0	µA
MOS FET	Off-state Leakage Current	ILoff	IF = 10 mA, VD = 400 V			0.03	1.0	µA
	Output Capacitance	Cout	VD = 0 V, f = 1 MHz, IF = 10 mA			185		pF/ch
Coupled	LED Off-state Current	IFoff	IL = 150 mA				2.0	mA
	On-state Resistance	Ron1	IF = 0 mA, IL = 10 mA			20	30	Ω
		Ron2	IF = 0 mA, IL = 150 mA, t ≤ 10 ms			16	25	
	Turn-on Time *1	ton	IF = 10 mA, Vo = 5 V,	IF = 10 mA, Vo = 5 V,		0.02	0.2	ms
	Turn-off Time *1	toff	RL = 1.5 kΩ, PW ≥ 10 ms	RL = 500 Ω, PW ≥ 10 ms		0.2	1.0	
	Isolation Resistance	RI-o	VI-o = 1.0 kVDC		10 <sup>9</sup>			Ω
	Isolation Capacitance	CI-o	V = 0 V, f = 1 MHz			1.1		pF/ch

\*1 Test Circuit for Switching Time

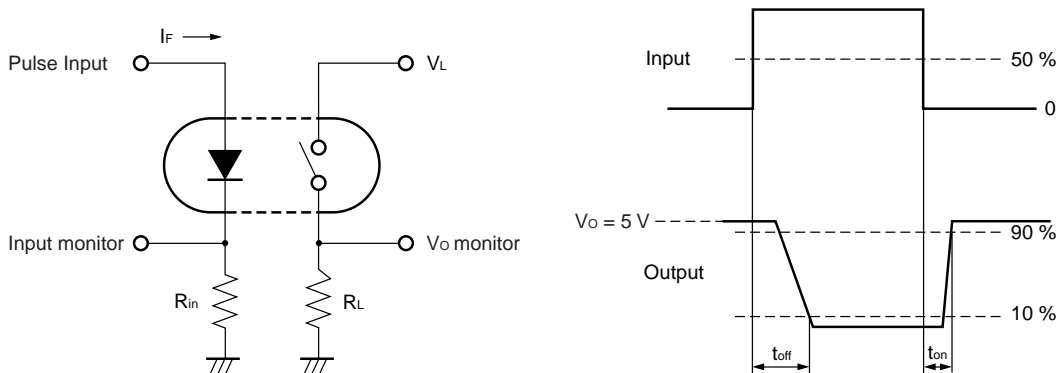

★ TYPICAL CHARACTERISTICS ( $T_A = 25\text{ }^\circ\text{C}$ , unless otherwise specified)

MAXIMUM FORWARD CURRENT vs. AMBIENT TEMPERATURE

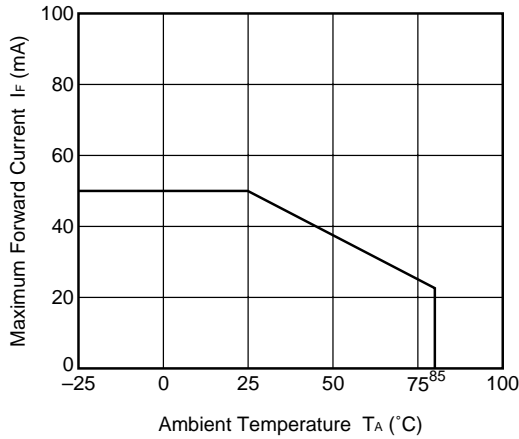

MAXIMUM LOAD CURRENT vs. AMBIENT TEMPERATURE

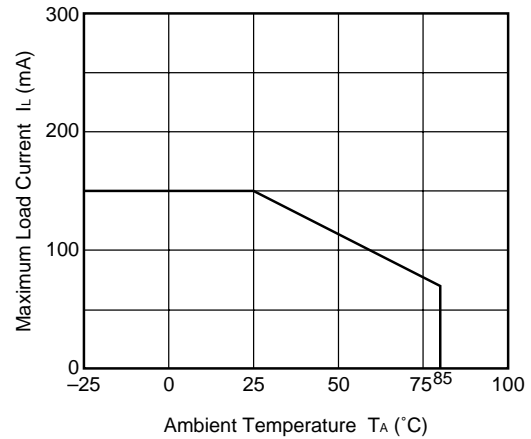

FORWARD VOLTAGE vs. AMBIENT TEMPERATURE

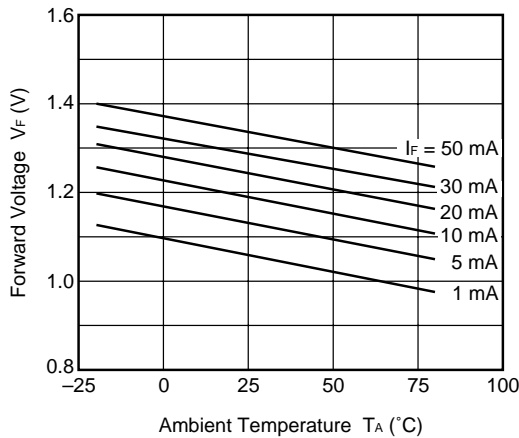

OUTPUT CAPACITANCE vs. APPLIED VOLTAGE

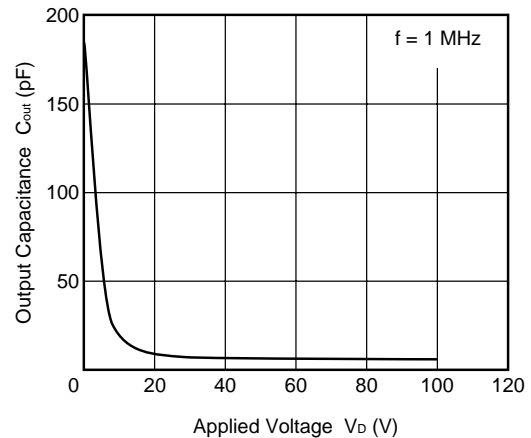

OFF-STATE LEAKAGE CURRENT vs. APPLIED VOLTAGE

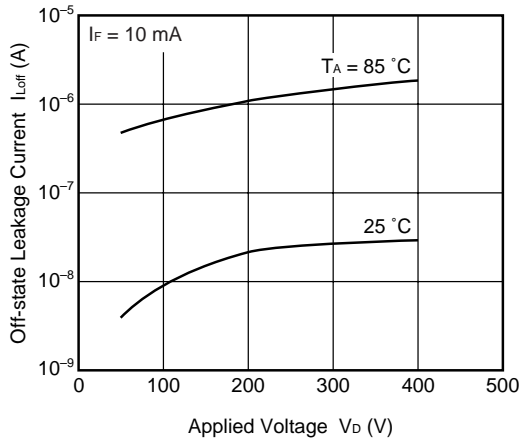

LOAD CURRENT vs. LOAD VOLTAGE

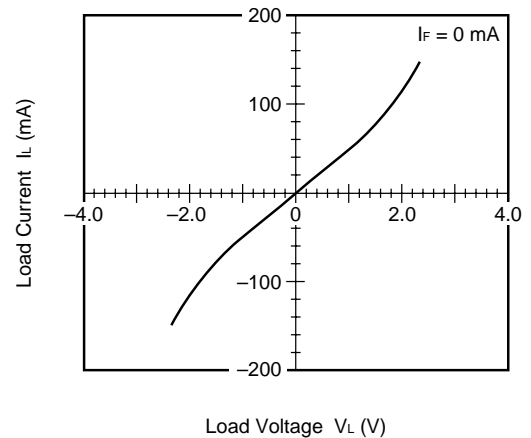

NORMALIZED ON-STATE RESISTANCE vs. AMBIENT TEMPERATURE

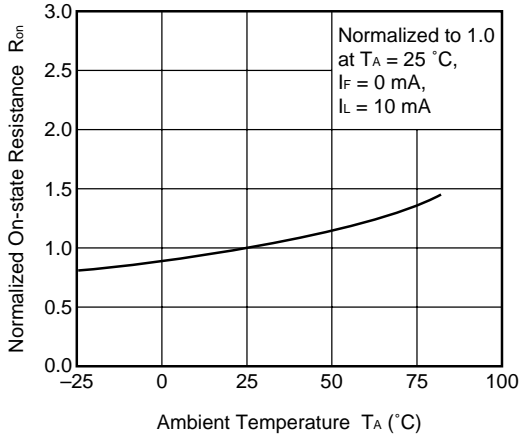

ON-STATE RESISTANCE DISTRIBUTION

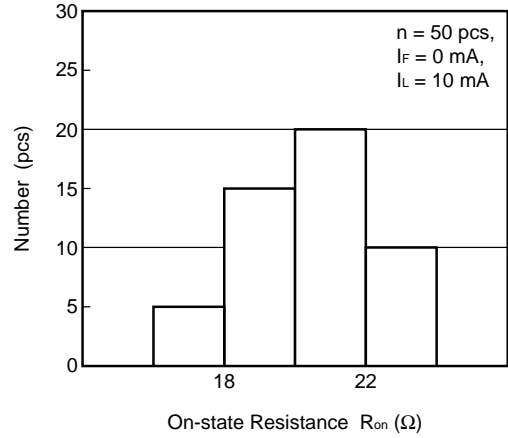

TURN-ON TIME vs. FORWARD CURRENT

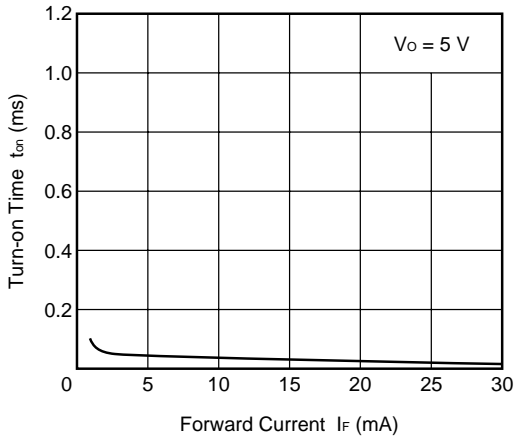

TURN-OFF TIME vs. FORWARD CURRENT

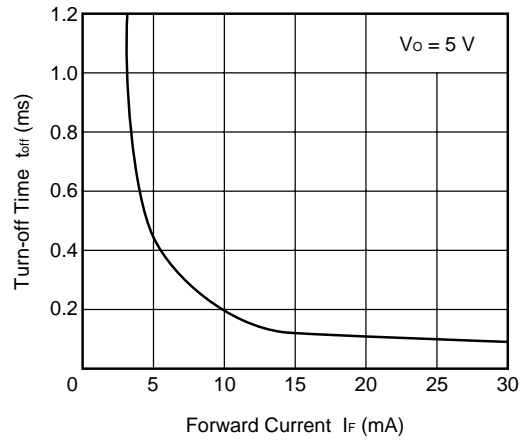

TURN-ON TIME DISTRIBUTION

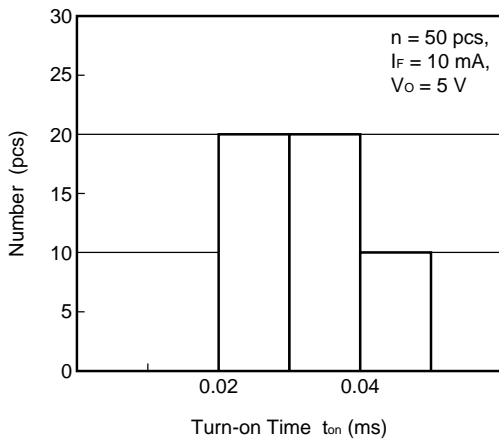

TURN-OFF TIME DISTRIBUTION

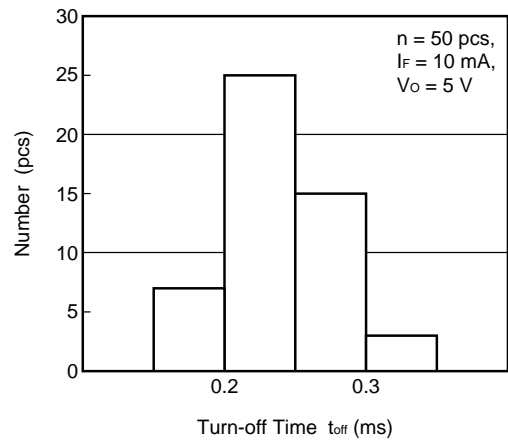

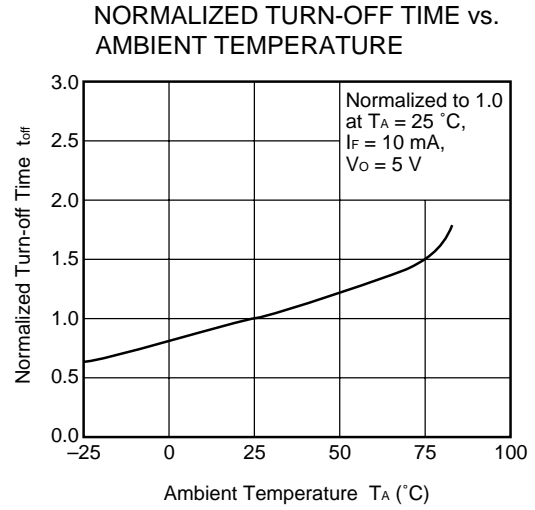
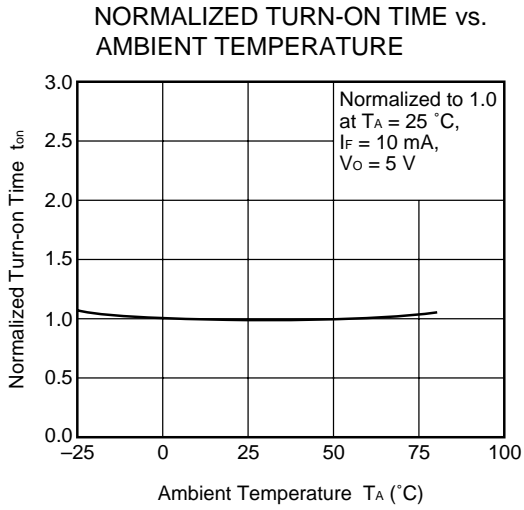

**Remark** The graphs indicate nominal characteristics.



★ TAPING SPECIFICATIONS (in millimeters)

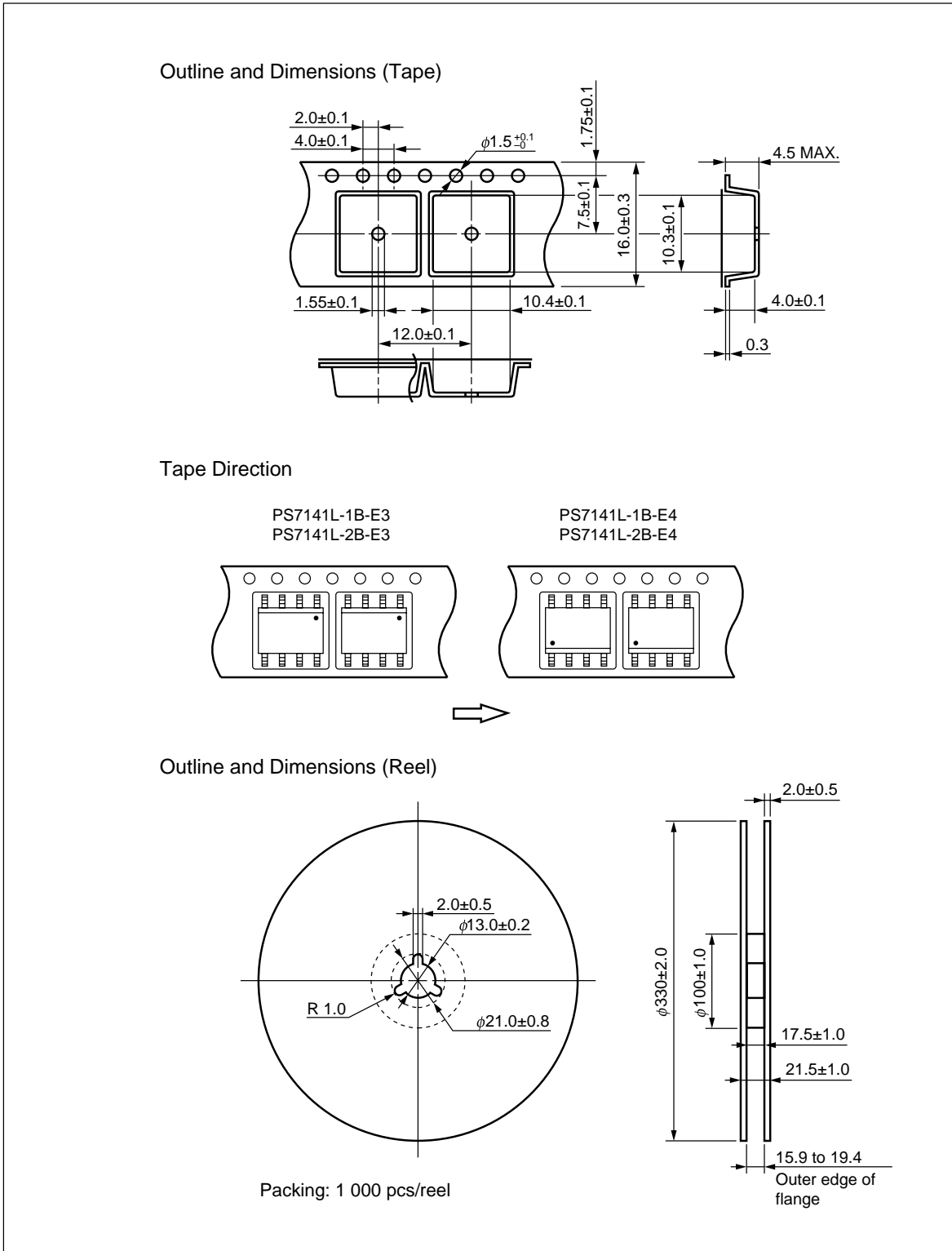

★ **RECOMMENDED SOLDERING CONDITIONS**

**(1) Infrared reflow soldering**

- Peak reflow temperature 260°C or below (package surface temperature)
- Time of peak reflow temperature 10 seconds or less
- Time of temperature higher than 220°C 60 seconds or less
- Time to preheat temperature from 120 to 180°C 120±30 s
- Number of reflows Three
- Flux Rosin flux containing small amount of chlorine (The flux with a maximum chlorine content of 0.2 Wt% is recommended.)

Recommended Temperature Profile of Infrared Reflow

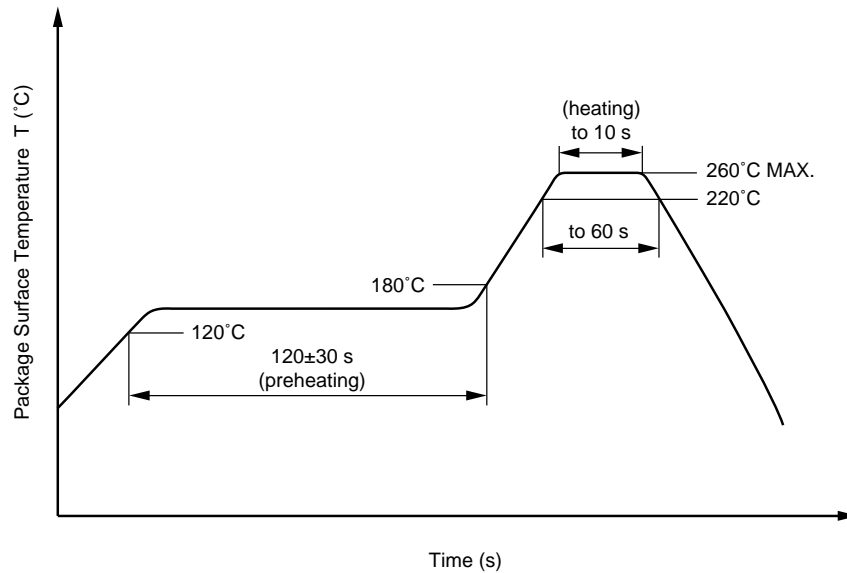

**(2) Wave soldering**

- Temperature 260°C or below (molten solder temperature)
- Time 10 seconds or less
- Preheating conditions 120°C or below (package surface temperature)
- Number of times One
- Flux Rosin flux containing small amount of chlorine (The flux with a maximum chlorine content of 0.2 Wt% is recommended.)

**(3) Cautions**

- Fluxes  
Avoid removing the residual flux with freon-based and chlorine-based cleaning solvent.

Subject: Compliance with EU Directives

CEL certifies, to its knowledge, that semiconductor and laser products detailed below are compliant with the requirements of European Union (EU) Directive 2002/95/EC Restriction on Use of Hazardous Substances in electrical and electronic equipment (RoHS) and the requirements of EU Directive 2003/11/EC Restriction on Penta and Octa BDE.

CEL Pb-free products have the same base part number with a suffix added. The suffix –A indicates that the device is Pb-free. The –AZ suffix is used to designate devices containing Pb which are exempted from the requirement of RoHS directive (\*). In all cases the devices have Pb-free terminals. All devices with these suffixes meet the requirements of the RoHS directive.

This status is based on CEL’s understanding of the EU Directives and knowledge of the materials that go into its products as of the date of disclosure of this information.

Restricted Substance per RoHS	Concentration Limit per RoHS (values are not yet fixed)	Concentration contained in CEL devices	
		-A	-AZ
Lead (Pb)	< 1000 PPM	Not Detected	(*)
Mercury	< 1000 PPM	Not Detected	
Cadmium	< 100 PPM	Not Detected	
Hexavalent Chromium	< 1000 PPM	Not Detected	
PBB	< 1000 PPM	Not Detected	
PBDE	< 1000 PPM	Not Detected	

If you should have any additional questions regarding our devices and compliance to environmental standards, please do not hesitate to contact your local representative.

**Important Information and Disclaimer:** Information provided by CEL on its website or in other communications concerning the substance content of its products represents knowledge and belief as of the date that it is provided. CEL bases its knowledge and belief on information provided by third parties and makes no representation or warranty as to the accuracy of such information. Efforts are underway to better integrate information from third parties. CEL has taken and continues to take reasonable steps to provide representative and accurate information but may not have conducted destructive testing or chemical analysis on incoming materials and chemicals. CEL and CEL suppliers consider certain information to be proprietary, and thus CAS numbers and other limited information may not be available for release.

In no event shall CEL’s liability arising out of such information exceed the total purchase price of the CEL part(s) at issue sold by CEL to customer on an annual basis.

See CEL Terms and Conditions for additional clarification of warranties and liability.