

FEATURES

- **2 CHANNEL TYPE:**
(1a + 1a output)
- **DESIGNED FOR AC/DC SWITCHING LINE CHANGER**
- **SMALL PACKAGE:**
8 pin DIP
- **LOW OFFSET VOLTAGE**
- **SURFACE MOUNT TYPE LEAD:**
PS7111L-2A
- **LOW LED OPERATING CURRENT:**
 $I_F = 2 \text{ mA}$

DESCRIPTION

PS7111-2A and PS7111L-2A are solid state relays containing GaAs LEDs on the light emitting side (input side) and MOSFETs on the (output side). They are suitable for analog signal control because of their low offset and high linearity.

APPLICATIONS

- EXCHANGE EQUIPMENT
- MEASUREMENT EQUIPMENT
- FA/OA EQUIPMENT

ELECTRICAL CHARACTERISTICS ($T_A = 25 \text{ }^\circ\text{C}$)

PART NUMBER			PS7111-2A, PS7111L-2A			
	SYMBOLS	PARAMETERS	UNITS	MIN	TYP	MAX
Diode	V_F	Forward Voltage, $I_F = 10 \text{ mA}$	V		1.2	1.4
	I_R	Reverse Current, $V_R = 5 \text{ V}$	μA			5.0
MOS FET	I_{LOFF}	Off-State Leakage Current, $V_D = 100 \text{ V}$	μA		0.03	1.0
	C_{OUT}	Output Capacitance, $V_D = 0 \text{ V}$, $f = 1 \text{ MHz}$	pF/ch		57	
Coupled	I_{Fon}	LED On-state Current, $I_L = 100 \text{ mA}$	mA			2.0
	R_{ON1}	On-State Resistance, $I_F = 10 \text{ mA}$, $I_L = 10 \text{ mA}$	Ω		3.0	6.0
	R_{ON2}	On-State Resistance, $I_F = 10 \text{ mA}$, $I_L = 100 \text{ mA}$, $t \leq 10 \text{ ms}$	Ω			
Coupled	t_{ON}	Turn-on Time ¹	If = 10 mA, VL = 5 V, RL = 500 Ω , PW $\geq 10 \text{ ms}$	ms	0.1	0.4
	t_{OFF}	Turn-off Time ¹			0.03	0.2
	R_{I-O}	Isolation Resistance, $V_{I-O} = 1.0 \text{ kVcc}$	Ω	10^9		
	C_{I-O}	Isolation Capacitance, $V = 0 \text{ V}$, $f = 1 \text{ MHz}$	pF/ch		1.1	

Note:

1. Test Circuit for Switching Time

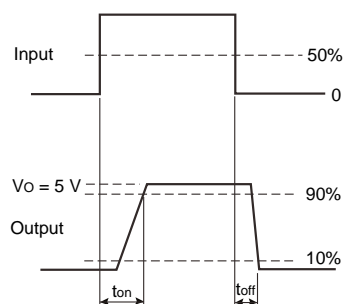
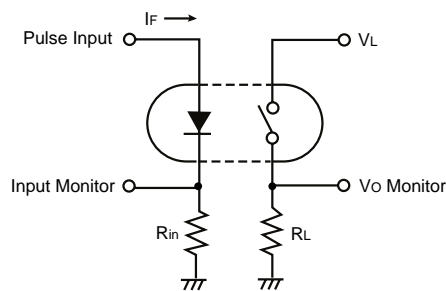

PS7111-2A, PS7111L-2A

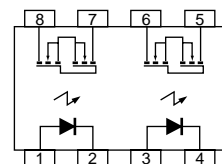

PS7111-2A, PS7111L-2A

ABSOLUTE MAXIMUM RATINGS¹ (T_A = 25°C)

SYMBOLS	PARAMETERS	UNITS	RATINGS
Diode			
I _F	Forward Current (DC)	mA	50
V _R	Reverse Voltage	V	5.0
P _D	Power Dissipation	mW/ch	50
I _{FP}	Peak Forward Current ²	A	1
MOSFET			
V _L	Break Down Voltage	V	100
I _L	Continuous Load Current	mA	100
I _{LP}	Pulse Load Current ³ (AC/DC Connection)	mA	300
P _D	Power Dissipation	mW/ch	375
Coupled			
BV	Isolation Voltage ⁴	V	1500
P _T	Total Power Dissipation	mW	850
T _A	Operating Ambient Temp.	°C	-40 to +80
T _{STG}	Storage Temperature	°C	-40 to +100

Notes:

1. Operation in excess of any one of these parameters may result in permanent damage.
2. PW = 100 μs, Duty Cycle = 1 %
3. PW = 100 ms, 1 shot.
4. AC voltage for 1 minute at T_A = 25 °C, RH = 60 % between input and output.

RECOMMENDED OPERATING CONDITIONS (T_A = 25°C)

PART NUMBER		PS7111-2A, PS7111L-2A			
SYMBOLS	PARAMETERS	UNITS	MIN	TYP	MAX
I _F	LED Operating Current	mA	2	10	20
V _F	LED Off Voltage	V	0		0.5

ORDERING INFORMATION

PART NUMBER	PACKAGE	PACKING STYLE
PS7111-2A	8 pin DIP	Magazine case 50 pcs
PS7111L-2A		Embossed Tape 1000 pcs/reel
PS7111L-2A-E3		
PS7111L-2A-E4		

OUTLINE DIMENSIONS (Units in mm)

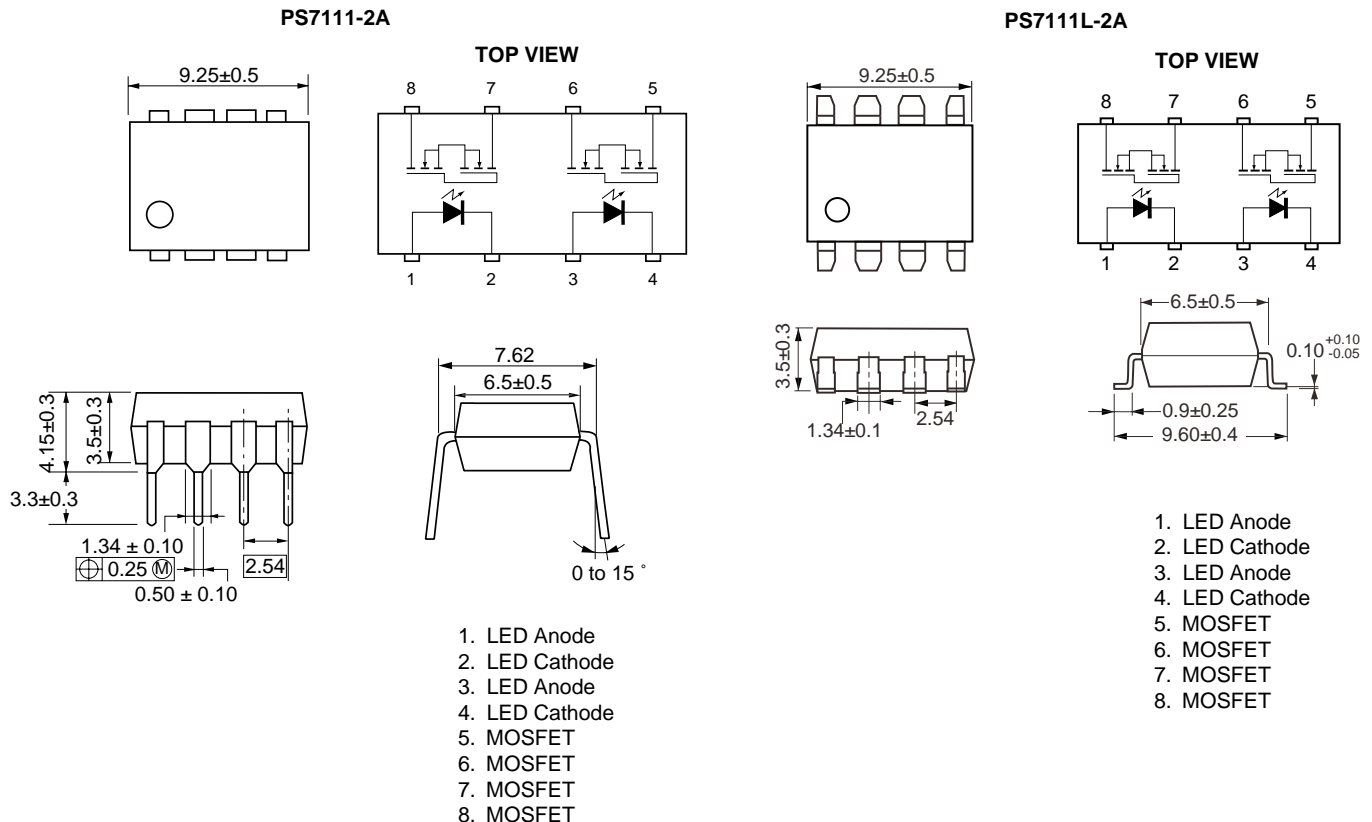

TYPICAL PERFORMANCE CURVES ($T_A = 25^\circ\text{C}$)

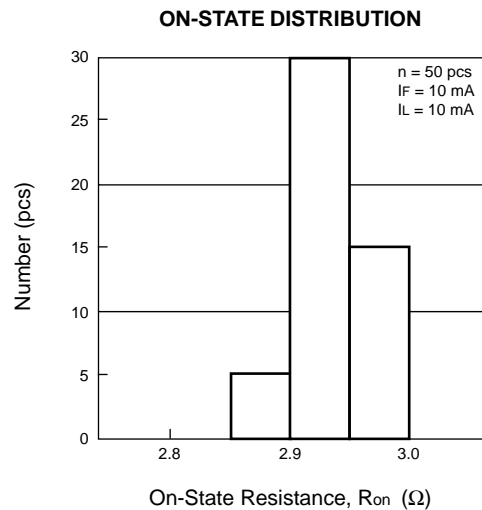
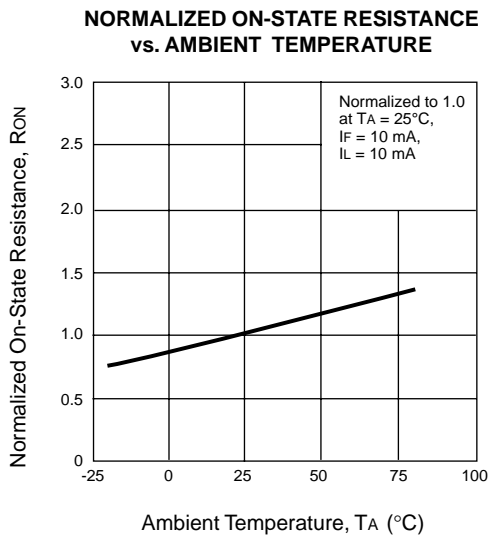
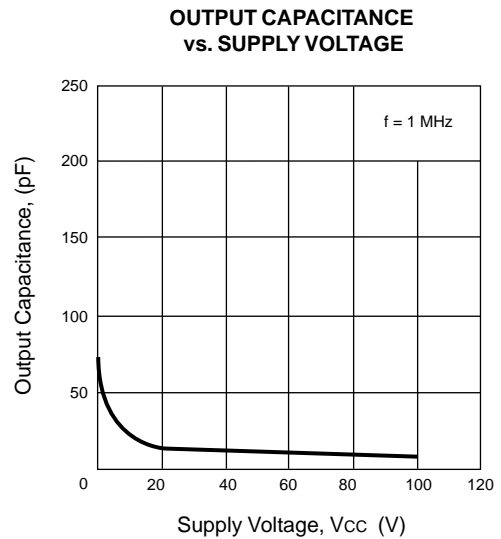
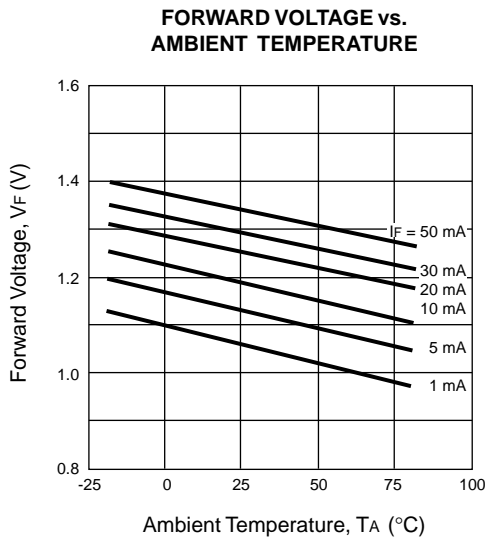
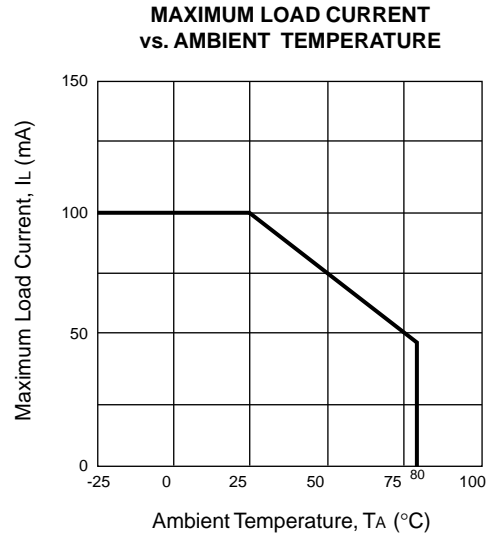
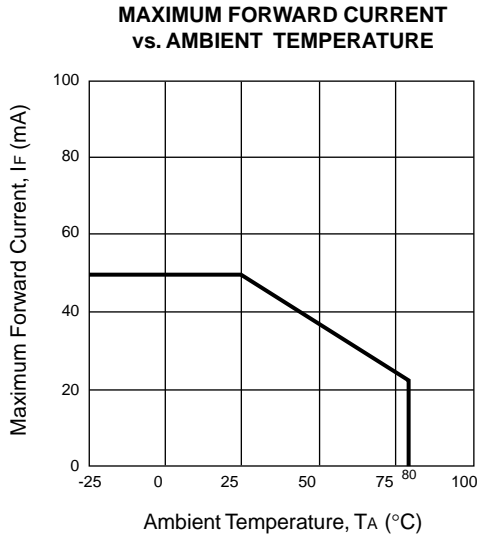

TYPICAL PERFORMANCE CURVES (TA = 25 °C)

OFF-STATE LEAKAGE CURRENT vs. SUPPLY VOLTAGE

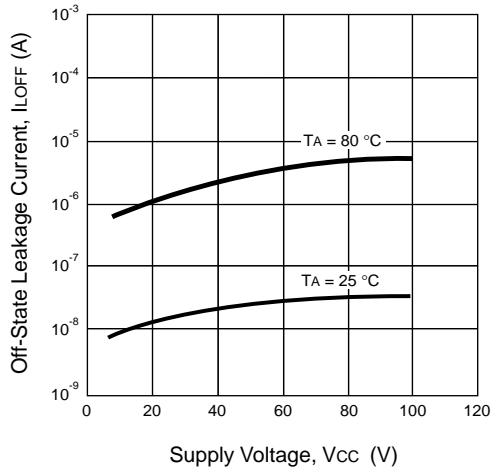

LOAD CURRENT vs. LOAD VOLTAGE

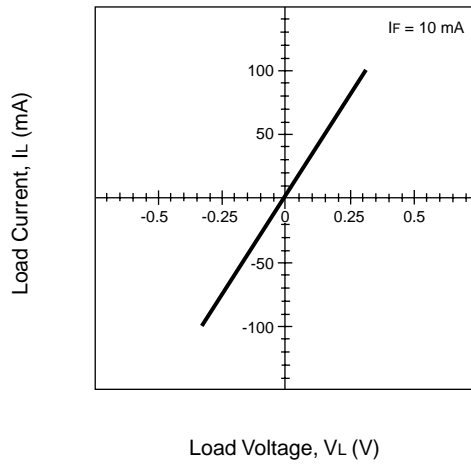

TURN-ON TIME vs. FORWARD CURRENT

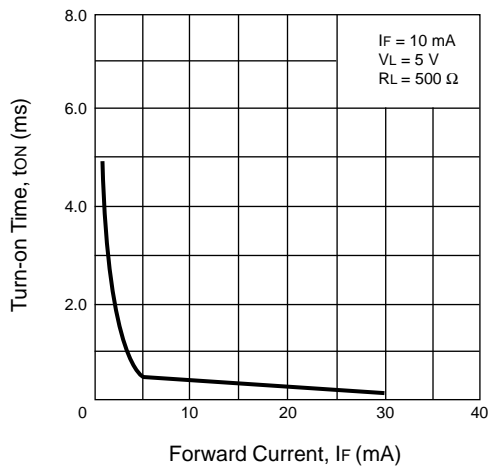

TURN-OFF TIME vs. FORWARD CURRENT

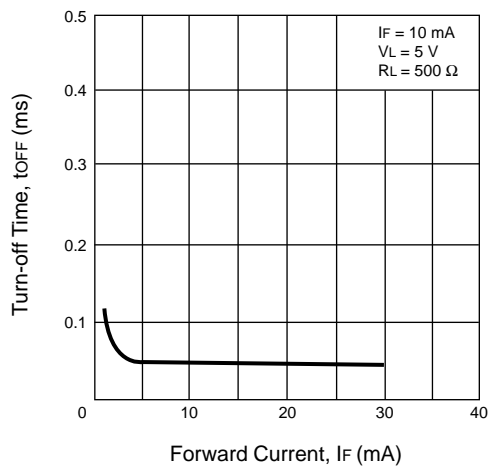

TURN-ON TIME DISTRIBUTION

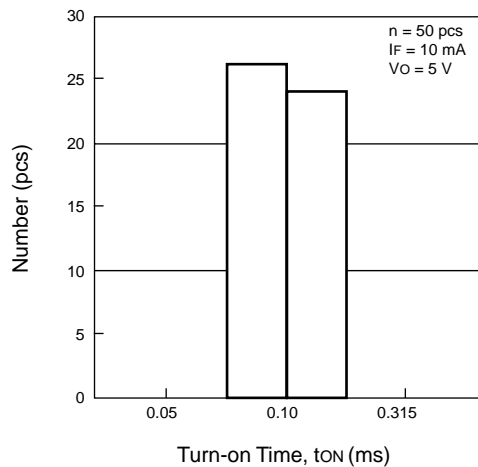

TURN-OFF TIME DISTRIBUTION

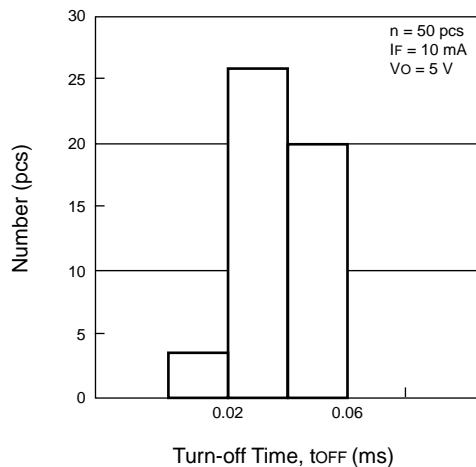

TYPICAL PERFORMANCE CURVES ($T_A = 25\text{ }^\circ\text{C}$)

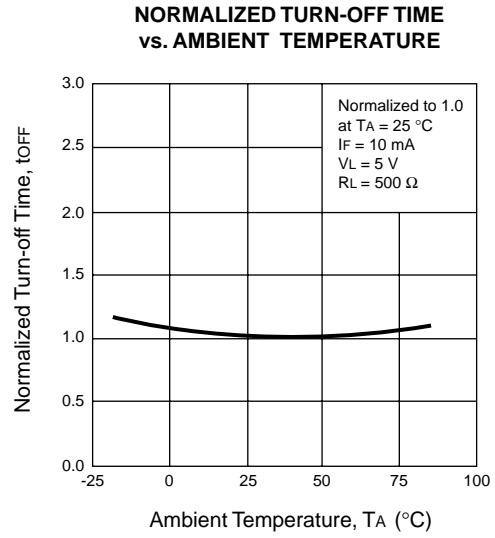
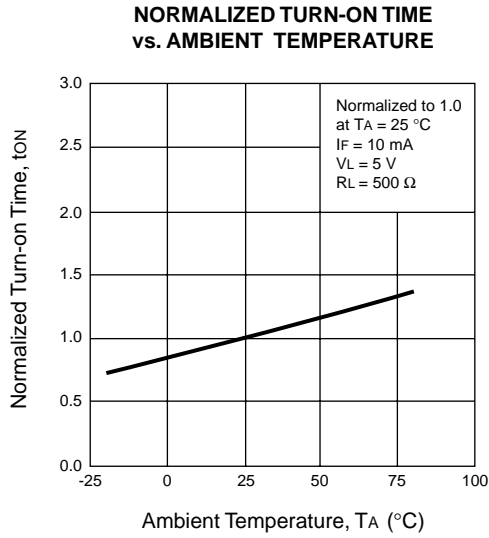

TAPING SPECIFICATIONS (Units in mm)

OUTLINE AND DIMENSIONS (TAPE)

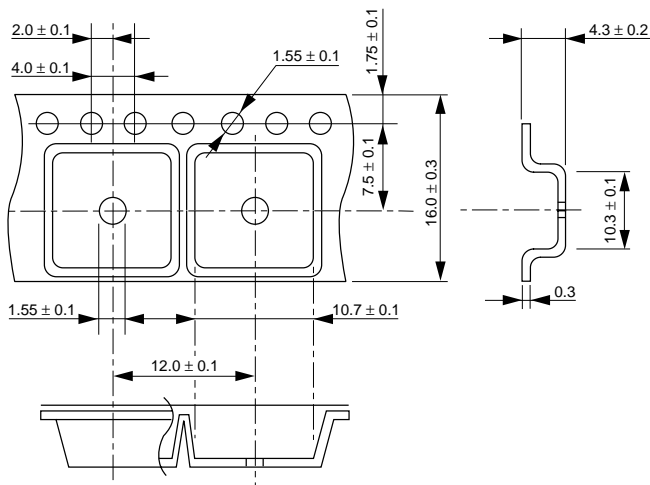

OUTLINE AND DIMENSIONS (REEL)

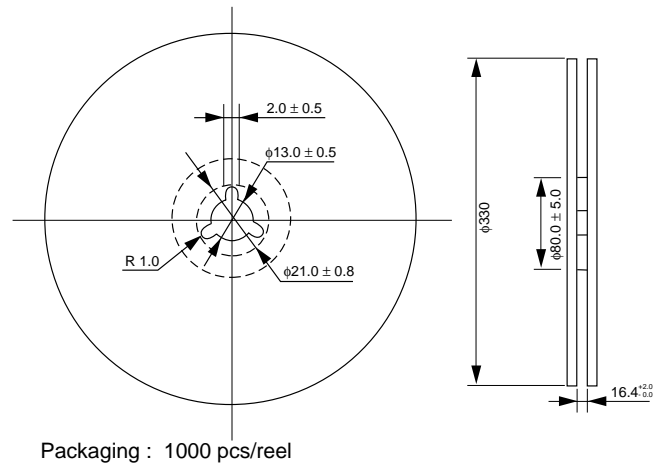

TAPING DIRECTION

PS7111L-2A-E3

PS7111L-2A-E4

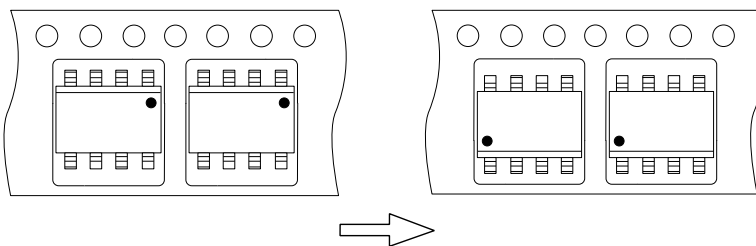

RECOMMENDED SOLDERING CONDITIONS

(1) Infrared reflow soldering

- Peak reflow temperature 235 °C or below (package surface temperature)
- Time of temperature higher than 210 °C 30 seconds or less
- Number of reflows Two
- Flux Rosin flux containing small amount of chlorine
(The flux with a maximum chlorine content of 0.2 Wt % is recommended.)

Recommended Temperature Profile of Infrared Reflow

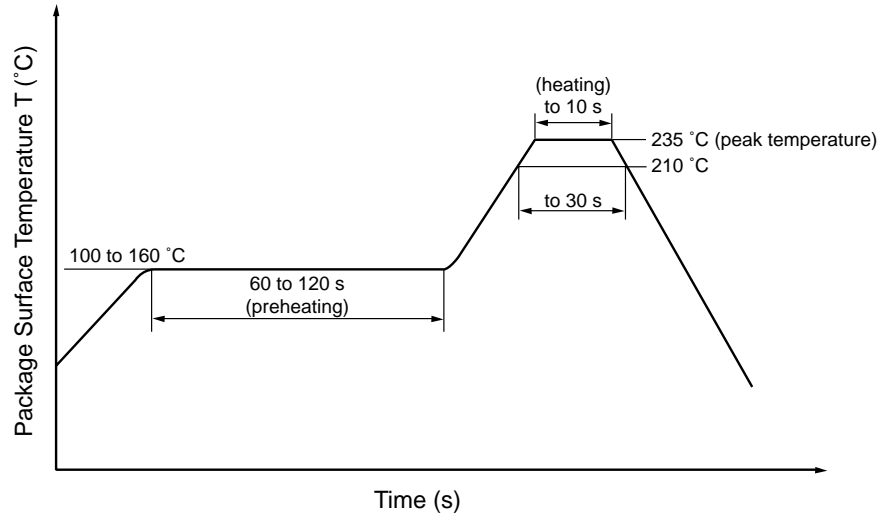

(2) Dip soldering

- Temperature 260 °C or below (molten solder temperature)
- Time 10 seconds or less
- Number of times One
- Flux Rosin flux containing small amount of chlorine
(The flux with a maximum chlorine content of 0.2 Wt % is recommended.)

(3) Cautions

- Fluxes Avoid removing the residual flux with freon-based cleaning solvent.