

Typical Applications

- Wireless Meter Reading
- Keyless Entry Systems
- 433/868/915MHz ISM Band Systems
- Wireless Data Transceiver
- Wireless Security Systems
- Battery Powered Portable Devices

Product Description

The RF2926 is a monolithic integrated circuit intended for use as a low cost FM transceiver. The device is provided in 48-lead plastic TQFP packaging and is designed to provide a dual conversion, half-duplex transceiver. The chip is intended for linear (AM, FM) or digital (ASK, FSK, OOK) applications in the North American 915MHz and European 433/868MHz ISM bands. The integrated VCO has a buffered output to feed the PLL IC to form the frequency synthesizer. Separate RX ENABL, TX ENABL, and PLL ENABL lines allow for half duplex operation as well as turning on the VCO to give the synthesizer time to settle and complete power down-mode.

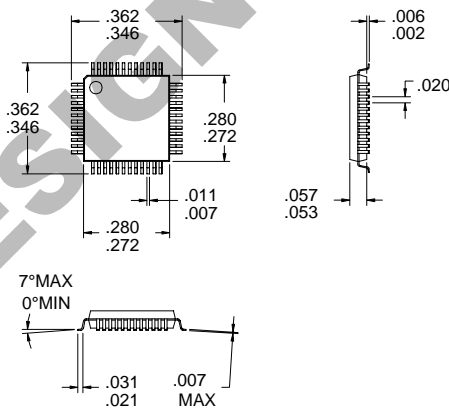

Optimum Technology Matching® Applied

- Si BJT GaAs HBT GaAs MESFET
 Si Bi-CMOS SiGe HBT Si CMOS

Package Style: LQFP-48

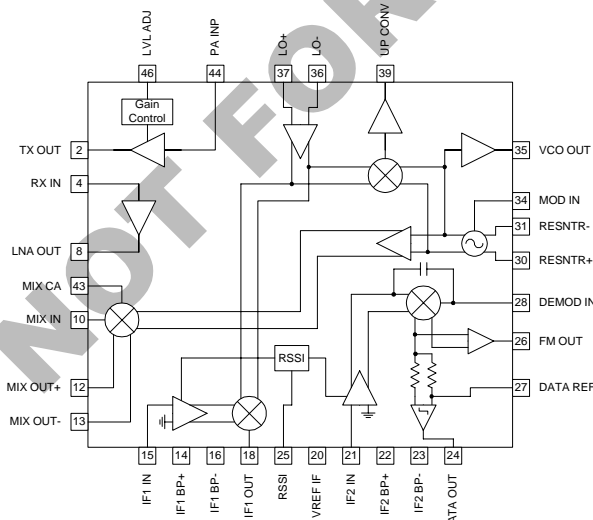

Functional Block Diagram

Features

- Monolithic Integrated Transceiver
- 2.7V to 5.0V Supply Voltage
- Narrow Band and Wide Band FM/FSK
- 300MHz to 1000MHz Frequency Range
- 130MHz Bandwidth in First IF
- 5mW Output Power at 433MHz

Ordering Information

RF2926 UHF Dual Conversion Transceiver
 RF2926 PCBA Fully Assembled Evaluation Board

RF Micro Devices, Inc.
 7625 Thorndike Road
 Greensboro, NC 27409, USA

Tel (336) 664 1233
 Fax (336) 664 0454
<http://www.rfmd.com>

RF2926

Absolute Maximum Ratings

Parameter	Ratings	Unit
Supply Voltage	-0.5 to +5.5	V _{DC}
Control Voltages	-0.5 to +5.0	V _{DC}
Input RF Level	+10	dBm
Output Load VSWR	50:1	
Operating Ambient Temperature	-40 to +85	°C
Storage Temperature	-40 to +150	°C



Caution! ESD sensitive device.

RF Micro Devices believes the furnished information is correct and accurate at the time of this printing. However, RF Micro Devices reserves the right to make changes to its products without notice. RF Micro Devices does not assume responsibility for the use of the described product(s).

Parameter	Specification			Unit	Condition
	Min.	Typ.	Max.		
Overall					T=25 °C, V _{CC} =3.6V, Freq=433MHz
RF Frequency Range		300 to 1000		MHz	
VCO					
VCO Frequency Range		300 to 1000		MHz	50Ω load impedance
VCO OUT Level		-18		dBm	
VCO OUT Impedance		50		Ω	
Transmit Section					
Max Modulation Frequency	2			MHz	Freq=433MHz See plot Instantaneous frequency deviation is inversely proportional with the modulation voltage TX ENABL="1" TX ENABL="0" TX Mode Measured on eval board with RF filters in system.
Min Modulation Frequency	Set by loop filter bandwidth				
Maximum Power Level		+2		dBm	
Power Control Range	20			dB	
Power Control Sensitivity		TBD		dB/V	
Max FM Deviation	200			kHz	
Antenna Port Impedance		50		Ω	
Antenna Port Impedance		TBD		Ω	
Antenna Port VSWR			1.5:1		
Modulation Input Impedance	4			kΩ	
Harmonics			-50	dBm	
Spurious		TBD		dBc	
Overall Receive Section					
Frequency Range		300 to 1000		MHz	IF BW=400kHz, Freq=915MHz, S/N=8dB R _{LOAD} =51kΩ See plot
RX Sensitivity		-99		dBm	
RSSI DC Output Range		0.7 to 2.2		V	
RSSI Sensitivity		25		mV/dB	
RSSI Dynamic Range	70	80		dB	
LNA and Mixer					
Cascaded Gain		18		dB	Freq=915MHz; RX current 12mA Freq=915MHz; RX current 12mA Freq=915MHz; RX current 12mA
Cascaded Noise Figure		7		dB	
Cascaded Input IP ₃		-18.5		dBm	
LO Leakage			-70	dBm	
First IF Section					
IF 3dB Bandwidth		130		MHz	IF=110.6MHz, Z _L =330Ω
Voltage Gain		34		dB	
Noise Figure		13		dB	
Input IP ₃		TBD		mV _{PP}	
IF1 Input Impedance		330		Ω	
IF1 Output Impedance		330		Ω	

11

TRANSCIEVERS

Parameter	Specification			Unit	Condition
	Min.	Typ.	Max.		
Second IF Section					
IF Frequency Range	0.1	10.7	22	MHz	IF=10.7MHz At IF2 OUT pin $Z_{LOAD}=1\text{M}\Omega \parallel 3\text{pF}$; Output voltage is proportional with the instantaneous frequency deviation. $Z_{LOAD}>10\text{k}\Omega$ $Z_{LOAD}>10\text{k}\Omega$
Voltage Gain		60		dB	
IF2 Input Impedance		330		Ω	
IF2 Output Impedance		1		$\text{k}\Omega$	
Demod Input Impedance		10		$\text{k}\Omega$	
FM Output Impedance		500		Ω	
Data Output Impedance		>1		$\text{M}\Omega$	
FM Output Bandwidth		1.6		MHz	
Data Output Bandwidth	1.4			MHz	
Data Output Level	0.3		$V_{CC}-0.3$	V	
FM Output DC Level		2.6		V	
FM Output AC Level		200		mV _{PP}	
Power Down Control					
Logical Controls "ON"	2.0			V	Voltage supplied to the input
Logical Controls "OFF"			1.0	V	Voltage supplied to the input
Control Input Impedance	25k			Ω	
Power Supply					
Voltage		3.6		V	Specifications
		2.7 to 5.0		V	Operating limits
Current Consumption		37.3		mA	TX Mode, LVL ADJ=3.6V
		10.9		mA	TX Mode, LVL ADJ=0V
		10 to 18		mA	RX Mode; Current is adjustable
			1	μA	Power Down Mode
		3.8		mA	PLL Only Mode

RF2926

11

TRANSCIEVERS

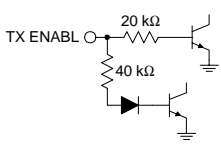
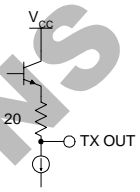
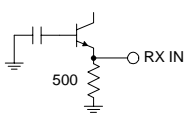
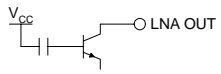
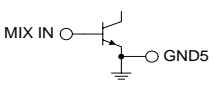
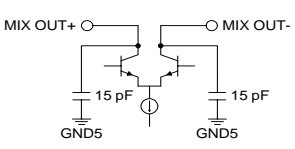
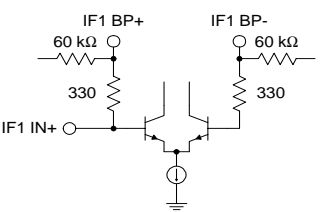
Pin	Function	Description	Interface Schematic
1	TX ENABL	Enables the transmitter circuits. TX ENABL > 2.0V powers up all transmitter functions. TX ENABL < 1.0V turns off all transmitter functions except the PLL functions.	
2	TX OUT	RF output pin for the transmitter electronics. TX OUT output impedance is a low impedance (see output impedance plot in Figure TBD) when the transmitter is enabled. TX OUT is a high impedance when the transmitter is disabled.	
3	GND2	Ground connection for the 40 dB IF limiting amplifier and Tx PA functions. Keep traces physically short and connect immediately to ground plane for best performance.	
4	RX IN	RF input pin for the receiver electronics. RX IN input impedance is a low impedance (see input impedance plot in Figure TBD) when the receiver is enabled. RX IN is a high impedance when the receiver is disabled.	
5	GND1	Ground connection for RF receiver functions. Keep traces physically short and connect immediately to ground plane for best performance.	
6	LNA GND	Ground connection for the LNA.	
7	LNA GND	Ground connection for the LNA.	
8	LNA OUT	Output pin for the receiver RF low noise amplifier. This pin is an open collector output and requires an external pull up coil to provide bias and tune the LNA output. A capacitor in series with this output can be used to match the LNA to 50Ω impedance image filters.	
9	GND3	Same as pin 4.	
10	MIX IN	RF input to the RF Mixer. An LC matching network between LNA OUT and MIX IN can be used to connect the LNA output to the RF mixer input in applications where an image filter is not needed or desired.	
11	GND5	GND5 is the ground connection shared by the input stage of the transmit power amplifier and the receiver RF mixer.	
12	MIX OUT+	Complementary (with respect to pin 13) IF output from the RF mixer. Alternately, an IF tank can be used to tailor the IF frequency and bandwidth to meet the needs of a given application.	
13	MIX OUT-	IF output from the RF mixer. For a balanced mixer output, pull-up inductors from pin 12 and 13 to Vcc and a capacitor between the pins should be used. The sum of the total pull-up inductance should be used to resonate the capacitor between pins 12 and 13.	See pin 12.
14	IF1 BP+	DC feedback node for the 40dB limiting amplifier strip. A 10nF bypass capacitor from this pin to ground is required.	See pin 16.
15	IF1 IN	IF input to the 40dB limiting amplifier strip. A DC blocking capacitor is required on this input. The value of this capacitor should be small enough as to not attenuate the IF frequency when terminated into the 330Ω input impedance.	

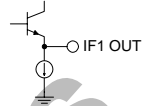
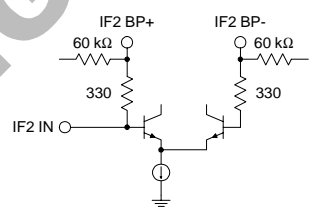
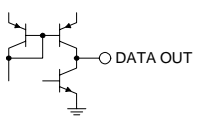
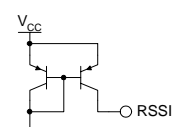
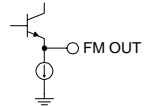
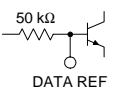
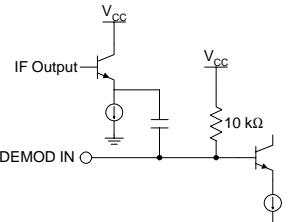
Pin	Function	Description	Interface Schematic
16	IF1 BP-	See pin 14.	See pin 15.
17	GND7	Ground connection for 40dB IF limiting amplifier. Keep traces physically short and connect immediately to ground plane for best performance.	
18	IF1 OUT	IF output from the 40dB limiting amplifier. The IF1 OUT output presents a nominal 330 Ω output resistance and interfaces directly to 10.7MHz ceramic filters.	
19	GND6	Ground connection for 60dB IF limiting amplifier. Keep traces physically short and connect immediately to ground plane for best performance.	
20	VREF IF	DC voltage reference for the IF limiting amplifiers. A 10nF capacitor from this pin to ground is required.	
21	IF2 IN	IF input to the 60dB limiting amplifier strip. A 10nF DC blocking capacitor is required on this input. The IF2 IN input presents a nominal 330 Ω input resistance and interfaces directly to 10.7MHz ceramic filters.	
22	IF2 BP+	DC feedback node for the 60dB limiting amplifier strip. A 10nF bypass capacitor from this pin to ground is required.	See pin 20.
23	IF2 BP-	See pin 21.	See pin 20.
24	DATA OUT	Demodulated data output from the demodulator. Output levels on this are TTL/CMOS compatible. The magnitude of the load impedance is intended to be 1 MΩ or greater.	
25	RSSI	A DC voltage proportional to the received signal strength is output from this pin. The output voltage range is 0.5V to 2.5V and increases with increasing signal strength.	
26	FM OUT	Linear output from the FM demodulator. This pin is used in analog applications when signal fidelity is important.	
27	DATA REF	This pin is used for setting the adaptive Data Slicer DC reference level. A capacitor from this pin to ground can be used to set the reference level at the average DC level of the data bit stream. The DC level determines the bit decision threshold.	
28	DEMOD IN	This pin is the input to the FM demodulator. This pin is NOT AC coupled. Therefore, a DC blocking capacitor is required on this pin to avoid shorting the demodulator input with the LC tank. A ceramic discriminator or DC blocked LC tank resonant at the IF should be connected to this pin.	
29	VCC4	This pin is used to supply DC bias to the 60dB IF limiting amplifier. An IF bypass capacitor should be connected directly to this pin and returned to ground. A 10nF capacitor is recommended for 10.7MHz IF applications.	

RF2926

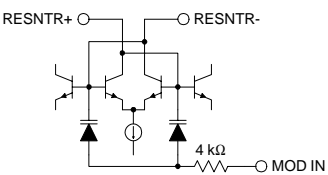
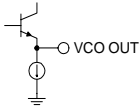
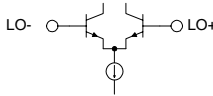
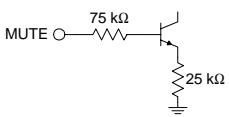
Pin	Function	Description	Interface Schematic
30	RESNTR+	This port is used to supply DC voltage to the VCO as well as to tune the center frequency of the VCO. Equal value inductors should be connected to this pin and pin 31 although a small imbalance can be used to tune in the proper frequency range.	
31	RESNTR-	See RESNTR+ description.	See pin 30.
32	VCC2	This pin is used to supply DC bias to the VCO and buffer amps. A 10nF capacitor is recommended for 10.7MHz IF applications.	
33	GND4	GND4 is the ground shared on chip by the VCO, prescaler, and PLL electronics.	
34	MOD IN	FM analog or digital modulation can be imparted to the VCO through this pin. The VCO varies in accordance to the voltage level presented to this pin. To set the deviation to a desired level, a voltage divider referenced to V _{CC} is the recommended. This deviation is also dependent upon the overall capacitance of the external resonant circuit.	See pin 30.
35	VCO OUT	This pin is used to supply a buffered VCO output to go to the PLL chip. This pin has a DC bias and needs to be AC coupled.	
36	LO-	Balanced input for the first LO. This signal is presented to both the receiver second downconverter and transmit upconverter.	
37	LO+	Complementary input of LO-.	See pin 36.
38	GND8	Ground for LO amp and transmit upconverter. Keep traces physically short and immediately to the ground plane for best performance.	
39	UP CONV	The output of the transmit signal upconverter. This signal should be filtered to remove the undesired sideband and spurs before being applied to the PA input, pin 45.	
40	GND9	Same as pin 38.	See pin 38.
41	VCC1	This pin is used to supply DC bias to the receiver RF electronics. A RF bypass capacitor should be connected directly to this pin and returned to ground. A 100pF capacitor is recommended for 915MHz applications. A 220pF capacitor is recommended for 433MHz applications.	
42	MUTE	This pin is used to mute the data output (DATA OUT). MUTE>2.0V turns the DATA OUT signal on. MUTE<1.0V turns the DATA OUT signal off. The MUTE signal should be logic low in the Sleep Mode.	
43	MIX CA	Mixer Current Adjust. This pin is used to adjust the current in the receiver. A resistor connected to ground controls the bias current in the mixer. The resistor should vary between 1kΩ to open circuit to vary the current from 18mA to 10.6mA	
44	PA INP	Input of the transmit power amplifier.	
45	VCC3	This pin is used to supply DC bias to the transmitter PA. A RF bypass capacitor should be connected directly to this pin and returned to ground. A 100pF capacitor is recommended for 915MHz applications. A 220pF capacitor is recommended for 433MHz applications.	

Pin	Function	Description	Interface Schematic
46	LVL ADJ	This pin is used to vary the transmitter output power. An output level adjustment range greater than 12dB is provided through analog voltage control of this pin. DC current of the transmitter power amp is also reduced with output power. This pin MUST be low when the transmitter is disabled.	
47	PLL ENABL	This pin is used to power up or down the VCO and PLL. A logic high (PLL ENABL > 2.0V) powers up the VCO and PLL electronics. A logic low (PLL ENABL < 1.0V) powers down the PLL and VCO.	
48	RX ENABL	Enable pin for the receiver circuits. RX ENABL > 2.0V powers up all receiver functions. RX ENABL < 1.0V turns off all receiver functions except the PLL functions and the RF mixer.	

Pin Out

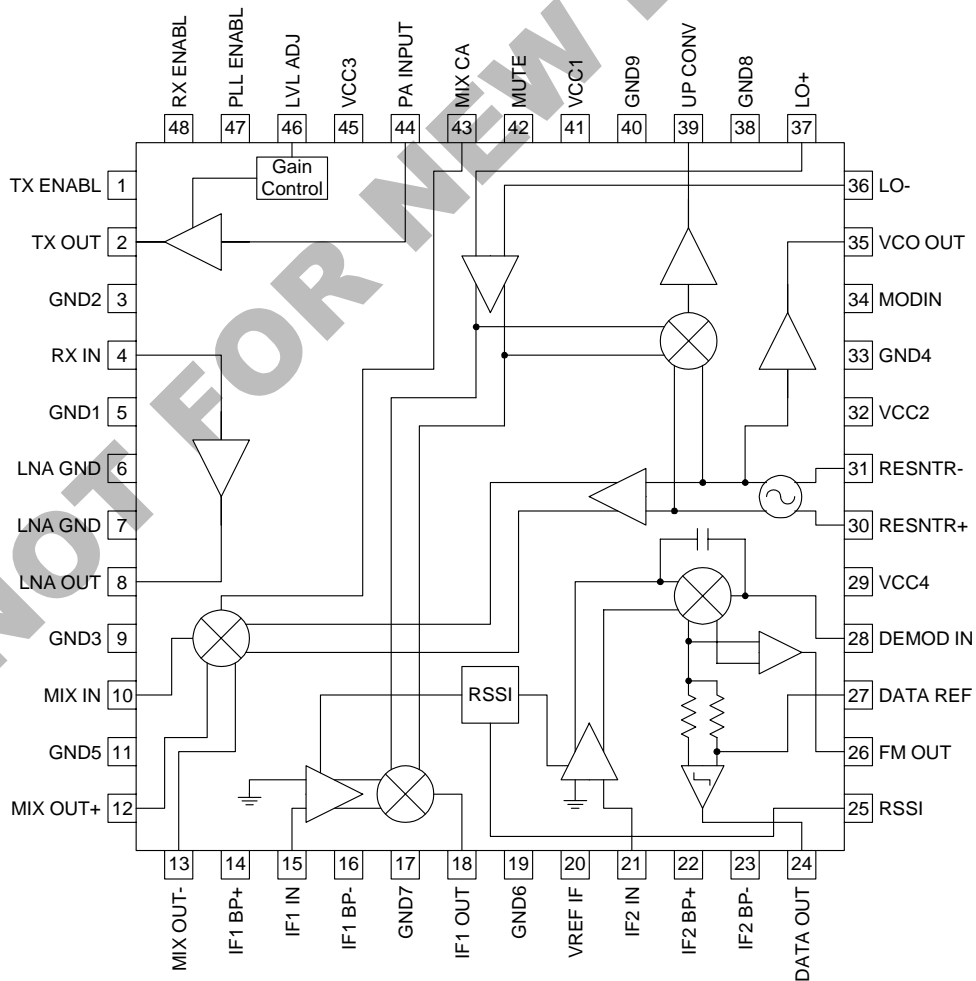

Application Schematic 915MHz

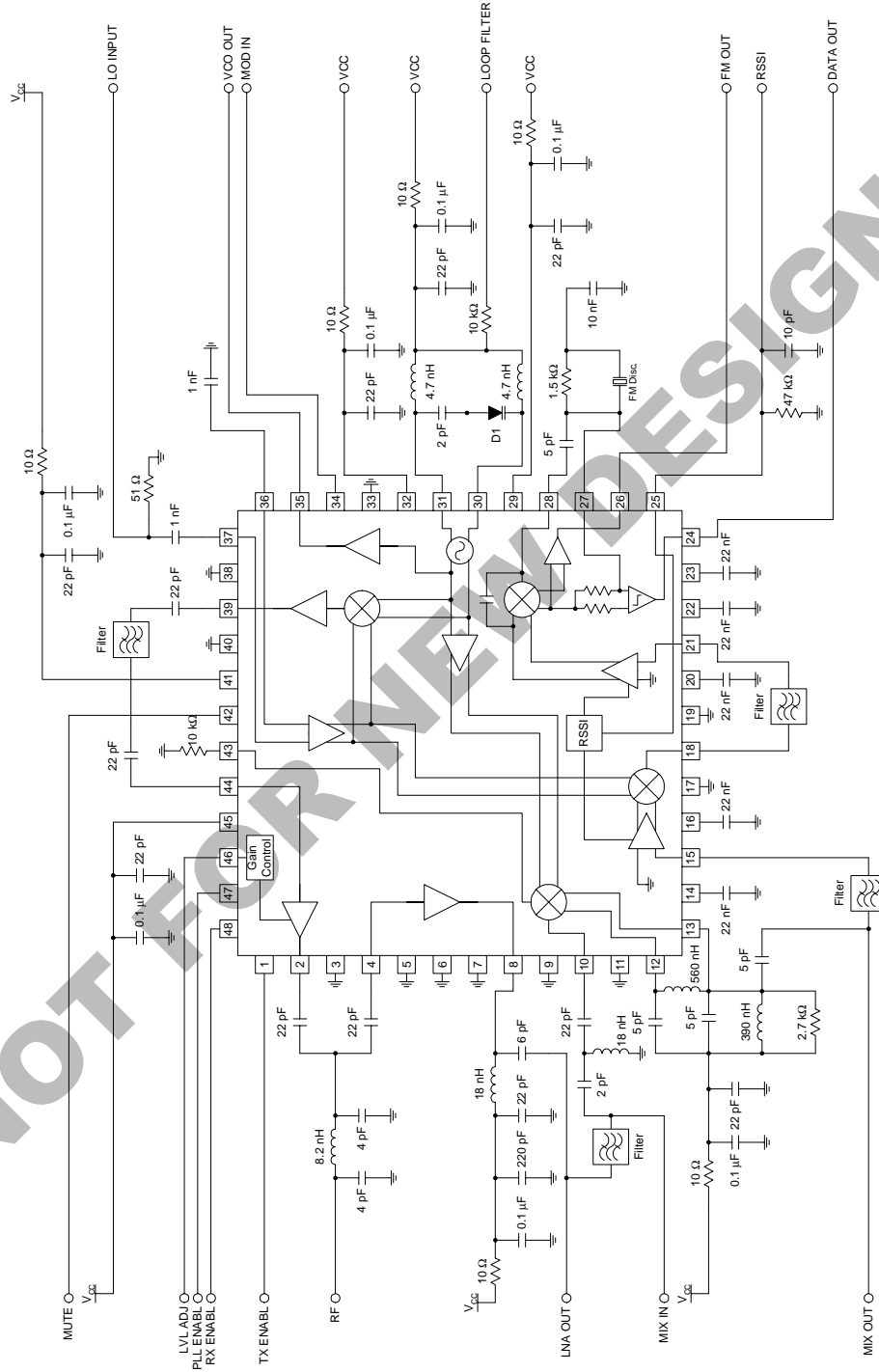

Evaluation Board Layout
Board Size 3.04" x 3.04"
Board Thickness 0.031", Board Material FR-4

