

TLP521GB, TLP521-2GB, TLP521-4GB, TLP521, TLP521-2, TLP521-4
 TLP521XGB, TLP521-2XGB, TLP521-4XGB
 TLP521X, TLP521-2X, TLP521-4X



**HIGH DENSITY MOUNTING
 PHOTOTRANSISTOR
 OPTICALLY COUPLED ISOLATORS**

APPROVALS

- UL recognised, File No. E91231
- 'X' SPECIFICATION APPROVALS
 - VDE 0884 in 3 available lead form :-
 - STD
 - G form
 - SMD approved to CECC 00802
 - BSI approved - Certificate No. 8001

DESCRIPTION

The TLP521, TLP521-2, TLP521-4 series of optically coupled isolators consist of infrared light emitting diodes and NPN silicon photo transistors in space efficient dual in line plastic packages.

FEATURES

- Options :-
 - 10mm lead spread - add G after part no.
 - Surface mount - add SM after part no.
 - Tape&reel - add SMT&R after part no.
- High Current Transfer Ratio (50% min)
- High Isolation Voltage (5.3kV_{RMS}, 7.5kV_{PK})
- High BV_{CEO} (55Vmin)
- All electrical parameters 100% tested
- Custom electrical selections available

APPLICATIONS

- Computer terminals
- Industrial systems controllers
- Measuring instruments
- Signal transmission between systems of different potentials and impedances

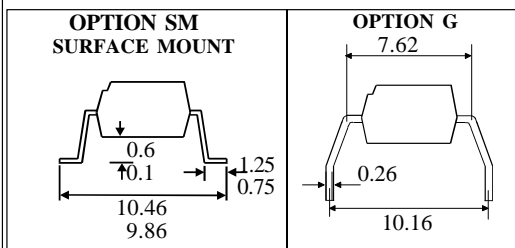

TLP521 Dimensions in mm

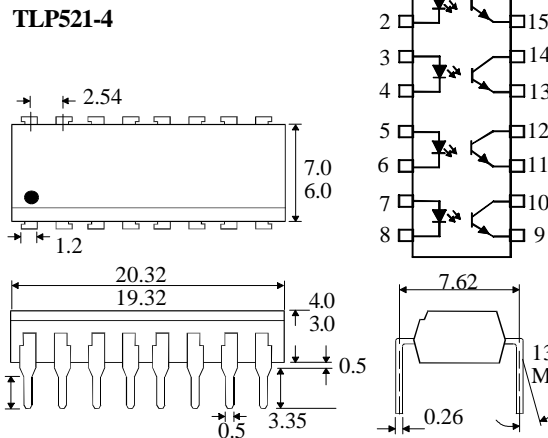
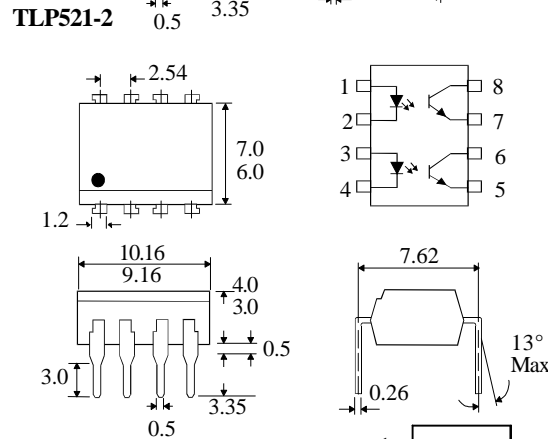
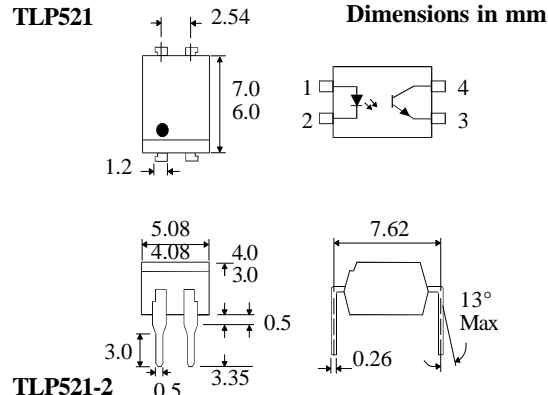

ISOCOM COMPONENTS LTD
 Unit 25B, Park View Road West,
 Park View Industrial Estate, Brenda Road
 Hartlepool, Cleveland, TS25 1YD
 Tel: (01429) 863609 Fax : (01429) 863581



ABSOLUTE MAXIMUM RATINGS
(25°C unless otherwise specified)

Storage Temperature	-55°C to + 125°C
Operating Temperature	-30°C to + 100°C
Lead Soldering Temperature (1/16 inch (1.6mm) from case for 10 secs)	260°C

INPUT DIODE

Forward Current	50mA
Reverse Voltage	6V
Power Dissipation	70mW

OUTPUT TRANSISTOR

Collector-emitter Voltage BV_{CEO}	55V
Emitter-collector Voltage BV_{ECO}	6V
Power Dissipation	150mW

POWER DISSIPATION

Total Power Dissipation	200mW
(derate linearly 2.67mW/°C above 25°C)	

ELECTRICAL CHARACTERISTICS ($T_A = 25^\circ\text{C}$ Unless otherwise noted)

PARAMETER		MIN	TYP	MAX	UNITS	TEST CONDITION
Input	Forward Voltage (V_F)	1.0	1.15	1.3	V	$I_F = 10\text{mA}$
	Reverse Current (I_R)			10	μA	$V_R = 4\text{V}$
Output	Collector-emitter Breakdown (BV_{CEO}) (Note 2)	55			V	$I_C = 0.5\text{mA}$
	Emitter-collector Breakdown (BV_{ECO})	6			V	$I_E = 100\mu\text{A}$
	Collector-emitter Dark Current (I_{CEO})			100	nA	$V_{CE} = 20\text{V}$
Coupled	Current Transfer Ratio (CTR) (Note 2) TLP521, TLP521-2, TLP521-4	50		600	%	$5\text{mA } I_F, 5\text{V } V_{CE}$
	CTR selection available BL	200		600	%	
	GB	100		600	%	
	GB	30			%	$1\text{mA } I_F, 0.4\text{V } V_{CE}$
	Collector-emitter Saturation Voltage $V_{CE(SAT)}$			0.4	V	$8\text{mA } I_F, 2.4\text{mA } I_C$
	-GB			0.4	V	$1\text{mA } I_F, 0.2\text{mA } I_C$
	Input to Output Isolation Voltage V_{ISO}	5300			V_{RMS}	See note 1
		7500			V_{PK}	See note 1
	Input-output Isolation Resistance R_{ISO}	5×10^{10}			Ω	$V_{IO} = 500\text{V}$ (note 1)
	Response Time (Rise), tr		4		μs	$V_{CE} = 2\text{V},$
Response Time (Fall), tf		3		μs	$I_C = 2\text{mA}, R_L = 100\Omega$	

Note 1 Measured with input leads shorted together and output leads shorted together.

Note 2 Special Selections are available on request. Please consult the factory.

Collector Power Dissipation vs. Ambient Temperature

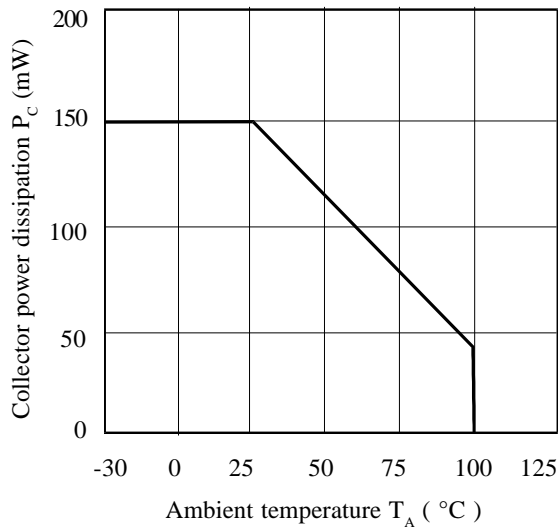

Collector Current vs. Low Collector-emitter Voltage

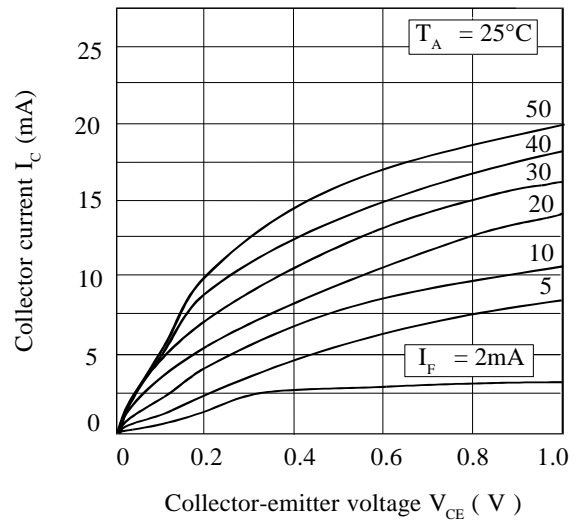

Forward Current vs. Ambient Temperature

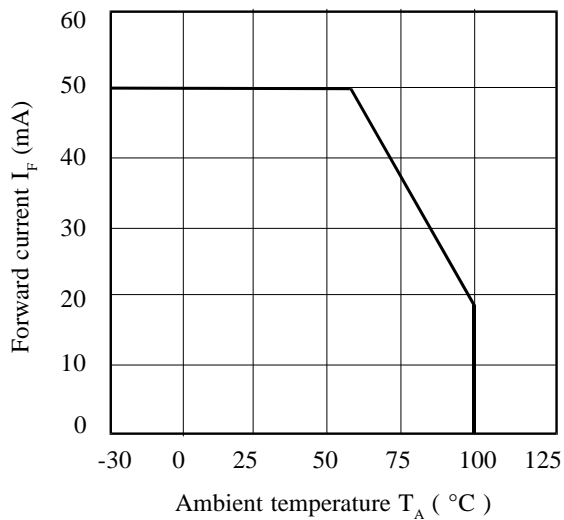

Collector Current vs. Collector-emitter Voltage

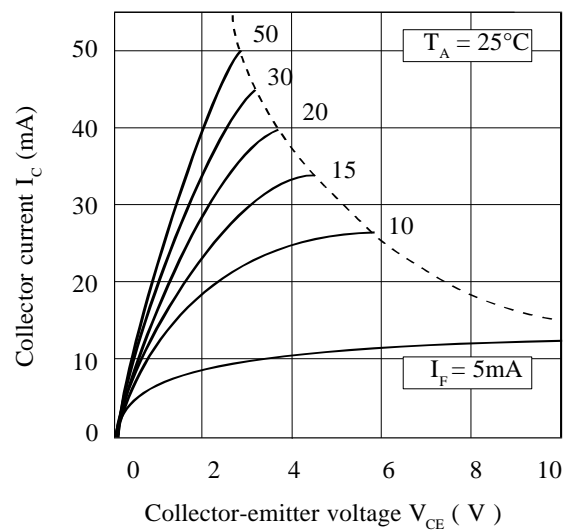

Collector-emitter Saturation Voltage vs. Ambient Temperature

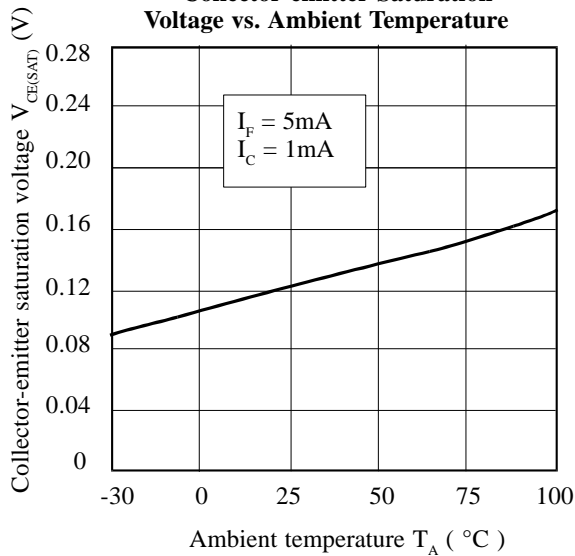

Current Transfer Ratio vs. Forward Current

