

■ METRAL® SIGNAL CONNECTORS STANDARD

- Header, 4 row, straight, wide body
- Header, 4 row, straight, narrow body
- Receptacle, 4 row, right angle
- Header, 5 row, straight, wide body
- Header, 5 row, straight, narrow body
- Receptacle, 5 row, right angle
- Header, 8 row, straight, wide body
- Receptacle, 8 row, right angle

Header, 4 row, signal, straight, solder to board, wide body

FEATURES

- In accordance with IEC 60917 and IEC 61076-4-104 (Futurebus+)
- 4 Rows and 2 mm pitch permit high signal density (200 contacts per 100 mm connector length).
- Stackable end-to-end without loss of positions.
- Stackable with other METRAL™ function modules (e.g. power, coax, guide pin).
- First Make Last Break options.

TECHNICAL DATA

PHYSICAL

- spacing: 2,00 mm x 2,00 mm
- housing: glass-filled LCP, colour natural
- flammability rating: UL 94 V-0
- pin material: phosphor bronze
- performance level: Telcordia CO

ELECTRICAL

- current rating: 1 A
- insulation resistance: $5 \times 10^3 \text{ M}\Omega$ initially, $1 \times 10^3 \text{ M}\Omega$ after tests
- withstanding voltage: 1000 V rms (sea level)

MECHANICAL PERFORMANCE

- insertion force: 0,45 N max. per individual signal contact (mating)
- withdrawal force: 0,15 N max. per individual signal contact (unmating)
- recommended hole diameter: 0,65-0,80 mm

ENVIRONMENTAL

- Operating temperature range: -55°C to +125°C
- RoHS information, this product is compatible according to the European Union Directive 2002/95/IEC

PACKAGING

- standard: tubes

PROCESSING INFORMATION

- applicable soldering process: wave, IR, vapor phase

REFERENCE DATA

- product specification.: GS-12-180

APPLICATION EQUIPMENT

- for application equipment, check out the application equipment table on page 217-223



MATING DATA

Receptacle, right angle, press-fit, page 34

- 1 mod – part number 88945-102LF
- 2 mod – part number 88946-102LF
- 4 mod – part number 88947-102LF
- 8 mod – part number 88948-102LF

Receptacle, right angle, solder-to-board, page 32

- 1 mod – part numbers 89035-102LF
- 2 mod – part numbers 89036-102LF
- 4 mod – part numbers 89037-102LF
- 8 mod – part numbers 89038-102LF

Receptacle, right angle, Pin-in-Paste, page 36

- 1 mod – part numbers 52048-101LF

TYPICAL APPLICATIONS

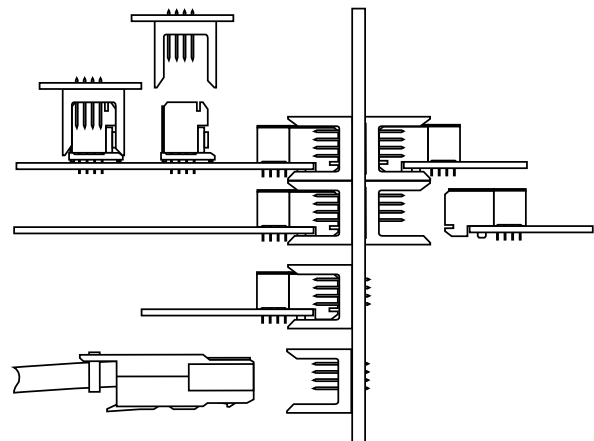

Header, 4 row, signal, straight, solder to board, wide body

PRODUCT

1 Module
88951-1yyLF

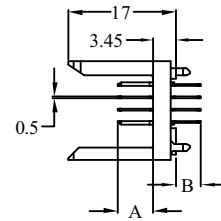
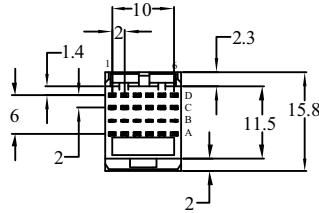
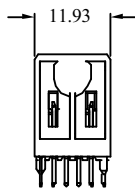

2 Module
88952-1yyLF

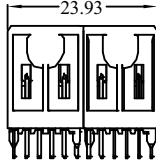

4 Module
88953-1yyLF

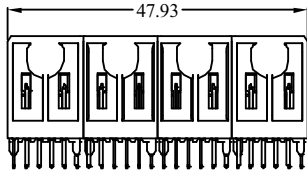

8 Module
88954-1yyLF

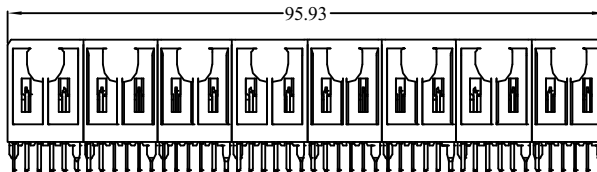

PCB pattern P5, see chapter PCB layouts

PARTNUMBERS

8895x - 1yyLF

Base Part Number

Performance

Pin Configuration

LF

88951 = 1 module (4 x 6 pos.)
88952 = 2 module (4 x 12 pos.)
88953 = 4 module (4 x 24 pos.)
88954 = 8 module (4 x 48 pos.)

1 = Telcordia CO

LF = lead free

yy	mating length (A)	tail length(B)
01	5,00 mm	4,25 mm
05	6,50 mm	4,25 mm
31	5,00 mm	3,30 mm
35	6,50 mm	3,30 mm
61	5,00 mm	2,65 mm

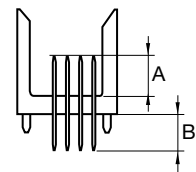

Note: for other special patterns or loadings, please check drawings, all other configurations on request only

Header, 4 row, signal, straight, press-fit, wide body

FEATURES

- In accordance with IEC 60917 and IEC 61076-4-104 (Futurebus+)
- 4 row and 2 mm pitch permit high signal density (200 contacts per 100mm connector length)
- Modular design guarantees flexibility
- Eye of the needle press-fit contact

TECHNICAL DATA

PHYSICAL

- spacing: 2,00 mm x 2,00 mm
- housing: glass-filled LCP, colour natural
- flammability rating: UL 94 V-0
- pin material: phosphor bronze
- performance level: Telcordia CO

ELECTRICAL

- current rating: 1 A
- insulation resistance: 5x10³ MΩ initially, 1x10³ MΩ after tests
- withstanding voltage: 1000 V rms (sea level)

MECHANICAL PERFORMANCE

- insertion force: 0,45 N max. per individual signal contact (mating)
- withdrawal force: 0,15 N max. per individual signal contact (unmating)
- press-fit contact insertion: 65 N max. per pin
- press-fit pin withdrawal: 15 N min. per pin
- recommended hole diameter: 0,65-0,80 mm

ENVIRONMENTAL

- Operating temperature range: -55°C to +125°C
- RoHs information, this product is compatible according to the European Union Directive 2002/95/IEC

PACKAGING

- standard: tubes

PROCESSING INFORMATION

- Applicable process: press-fit

REFERENCE DATA

- product specification.: GS-12-180

APPLICATION EQUIPMENT

- for application equipment, check out the application equipment table on page 217-223.



MATING DATA

Receptacle, right angle, press-fit, page 34

- 1 mod – part number 88945-102LF
- 2 mod – part number 88946-102LF
- 4 mod – part number 88947-102LF
- 8 mod – part number 88948-102LF

Receptacle, right angle, solder-to-board, page 32

- 1 mod – part numbers 89035-101LF
- 2 mod – part numbers 89036-101LF
- 4 mod – part numbers 89037-101LF
- 8 mod – part numbers 89038-101LF

Receptacle right angle, Pin-in-Paste, page 36

- 1 mod – part numbers 52048-101LF

TYPICAL APPLICATIONS

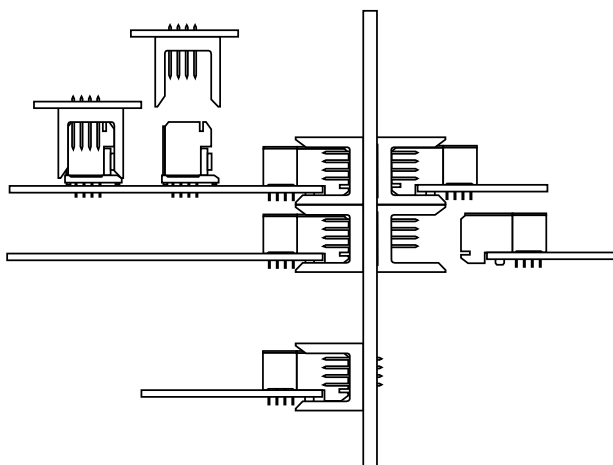

Header, 4 row, signal, straight, press-fit, wide body

PRODUCT

1 Module
70232-1yyLF

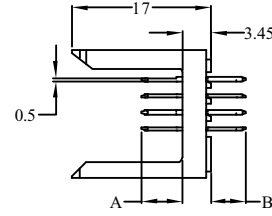
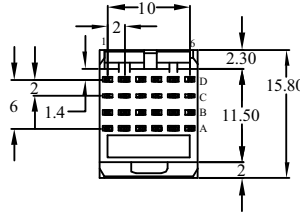
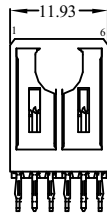

2 Module
70233-1yyLF

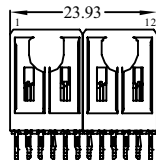

4 Module
70234-1yyLF

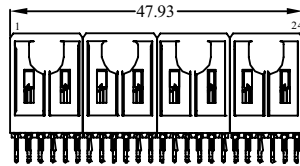

8 Module
70235-1yyLF

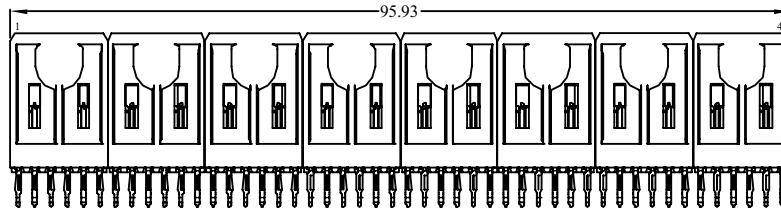

PCB pattern P6, see chapter PCB layouts

PARTNUMBERS

7023x - 1yyLF

Base Part Number

Performance

Pin Configuration

LF

70232 = 1 module (4 x 6 pos.)
70233 = 2 module (4 x 12 pos.)
70234 = 4 module (4 x 24 pos.)
70235 = 8 module (4 x 48 pos.)

1 = Telcordia CO

LF = lead free

yy	mating length (A)	tail length (B)
11	5,00 mm	4,30 mm
16	5,75 mm	4,30 mm
15	6,50 mm	4,30 mm
21	5,00 mm	13,60 mm
26	5,75 mm	13,60 mm
25	6,50 mm	13,60 mm

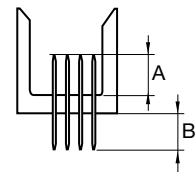

Note: blue marked in **pin configuration** is the preferred recommended standard
for other special patterns or loadings, please check drawings, all other configurations on request only

Header, 4 row, signal, straight, solder to board, narrow body

FEATURES

- In accordance with IEC 60917 and IEC 61076-4-104 (Futurebus+)
- 4 Rows and 2 mm pitch permit high signal density (200 contacts per 100 mm connector length).
- Stackable end-to-end without loss of positions.
- Stackable with other METRAL™ function modules (e.g. power, coax, guide pin).
- First Make Last Break options.

TECHNICAL DATA

PHYSICAL

- spacing: 2,00 mm x 2,00 mm
- housing: glass-filled LCP, colour natural
- flammability rating: UL 94 V-0
- pin material: phosphor bronze
- performance level: Telcordia CO

ELECTRICAL

- current rating: 1 A
- insulation resistance: $5 \times 10^3 \text{ M}\Omega$ initially, $1 \times 10^3 \text{ M}\Omega$ after tests
- withstanding voltage: 1000 V rms (sea level)

MECHANICAL PERFORMANCE

- insertion force: 0,45 N max. per individual signal contact (mating)
- withdrawal force: 0,15 N max. per individual signal contact (unmating)
- recommended hole diameter: 0,65-0,80 mm

ENVIRONMENTAL

- Operating temperature range: -55°C to +125°C
- RoHs information, this product is compatible according to the European Union Directive 2002/95/IEC

PACKAGING

- standard: tubes

PROCESSING INFORMATION

- applicable soldering process: wave, IR, vapor phase

REFERENCE DATA

- product specification.: GS-12-180

APPLICATION EQUIPMENT

- for application equipment, check out the application equipment table on page 217-223



MATING DATA

Receptacle, straight

- 1 mod - pf - part number 85757-1101LF, page 69
- 1 mod - stb -part nr HM1S41FRR000H6PLF, page 67

Receptacle, right angle

- 1 mod - pf - part number 88945-102LF, page 35
- 1 mod - stb -part number 89035-102LF, page 33
- 1 mod - pip -part number 52048-101LF, page 37

TYPICAL APPLICATIONS

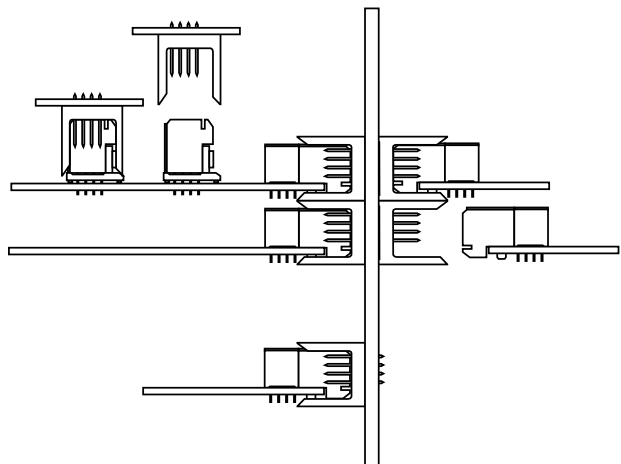

Header, 4 row, signal, straight, solder to board, narrow body

PRODUCT

1 Module
70264-1yyLF

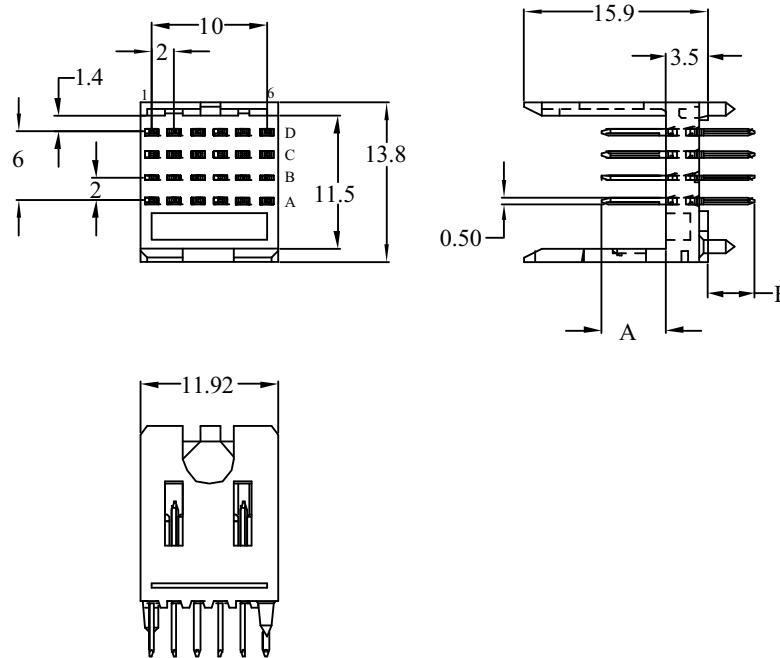

PCB pattern P3, see chapter PCB layouts

PARTNUMBERS

70264 - 1yyLF

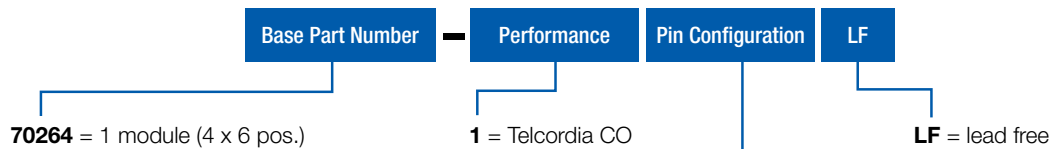

yy	mating length (A)	tail length (B)
01	5,00 mm	4,25 mm
05	6,50 mm	4,25 mm

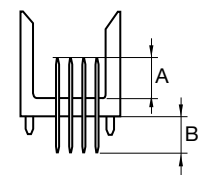

Note: for other special patterns or loadings, please check drawings, all other configurations on request only

Header, 4 row, signal, straight, press-fit, narrow body

FEATURES

- In accordance with IEC 60917 and IEC 61076-4-104 (Futurebus+)
- 4 Rows and 2 mm pitch permit high signal density (200 contacts per 100 mm connector length).
- Stackable end-to-end without loss of positions.
- Stackable with other METRAL™ function modules (e.g. power, coax, guide pin).
- First Make Last Break options.
- Eye the needle press-fit contact

TECHNICAL DATA

PHYSICAL

- spacing: 2,00 mm x 2,00 mm
- housing: glass-filled LCP, colour natural
- flammability rating: UL 94 V-0
- pin material: phosphor bronze
- performance level: Telcordia CO

ELECTRICAL

- current rating: 1 A
- insulation resistance: $5 \times 10^3 \text{ M}\Omega$ initially, $1 \times 10^3 \text{ M}\Omega$ after tests
- withstanding voltage: 1000 V rms (sea level)

MECHANICAL PERFORMANCE

- insertion force: 0,45 N max. per individual signal contact (mating)
- withdrawal force: 0,15 N max. per individual signal contact (unmating)
- press-fit contact insertion: 65 N max. per pin
- press-fit pin withdrawal: 15 N min. per pin
- recommended hole diameter: 0,65-0,80 mm

ENVIRONMENTAL

- Operating temperature range: -55°C to +125°C
- RoHs information, this product is compatible according to the European Union Directive 2002/95/IEC

PACKAGING

- standard: tubes

PROCESSING INFORMATION

- press fit

REFERENCE DATA

- product specification.: GS-12-180

APPLICATION EQUIPMENT

- for application equipment, check out the application equipment table on page 217-223



MATING DATA

Receptacle, straight

- 1 mod - pf - part number 85757-1101LF, page 69
- 1 mod - stb -part nr HM1S41FRR000H6PLF, page 67

Receptacle, right angle

- 1 mod - pf - part number 88945-102LF, page 35
- 1 mod - stb -part number 89035-102LF, page 33
- 1 mod - pip -part number 52048-101LF, page 37

TYPICAL APPLICATIONS

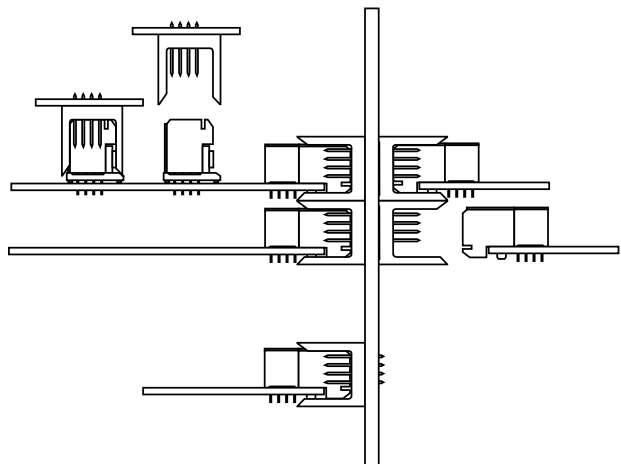

Header, 4 row, signal, straight, press-fit, narrow body

PRODUCT

1 Module
85826-1yyLF

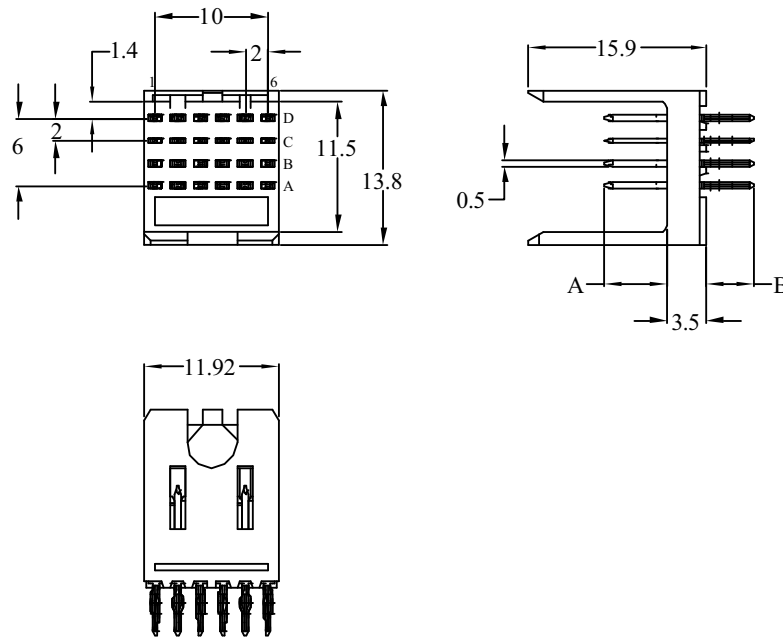

PCB pattern P4, see chapter PCB layouts

PARTNUMBERS

85826 - 1yyLF

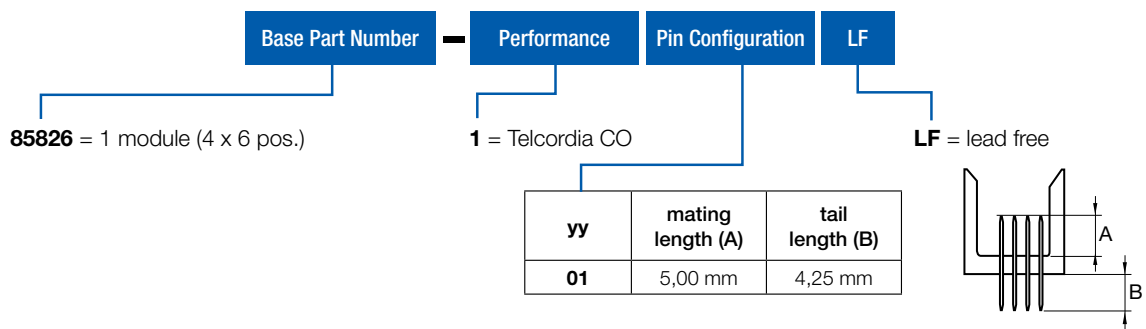

Note: for other special patterns or loadings, please check drawings, all other configurations on request only

Receptacle, 4 row, signal, right angle, solder to board

FEATURES

- In accordance with IEC 60917 and IEC 61076-4-104 (Futurebus+)
- 4 row and 2 mm pitch permit high signal density (200 contacts per 100mm connector length)
- Modular design guarantees flexibility
- Stackable end-to-end without loss of position
- Stackable with other METRAL® function modules (power, I/O)
- Reliable dual beam box contact
- Stable PCB fixation device
- Low profile allows PCB spacing of 14mm



TECHNICAL DATA

PHYSICAL

- spacing: 2,00 mm x 2,00 mm
- housing: glass-filled LCP, colour natural
- flammability rating: UL 94 V-0
- contact material: phosphor bronze
- performance level: Telcordia CO

ELECTRICAL

- current rating: 1 A
- insulation resistance: 5x10³ MΩ initially, 1x10³ MΩ after tests
- withstanding voltage: 1000 V rms (sea level)

MECHANICAL PERFORMANCE

- insertion force: 0,45 N max. per individual signal contact (mating)
- withdrawal force: 0,15 N max. per individual signal contact (unmating)
- Recommended hole diameter: 0,65 – 0,80 mm

ENVIRONMENTAL

- Operating temperature range: -55°C to +125°C
- RoHs information, this product is compatible according to the European Union Directive 2002/95/IEC

PACKAGING

- standard: tubes

PROCESSING INFORMATION

- Applicable process: wave, IR, vapor phase

REFERENCE DATA

- Press-peg application, TA-0941
- product specification.: GS-12-453

APPLICATION EQUIPMENT

- for application equipment, check out the application equipment table on page 217-223

MATING DATA

Header, straight, press-fit, page 27

- 1 module – part number 70232-116LF
- 2 modules – part number 70233-116LF
- 4 modules – part number 70234-116LF
- 8 modules – part number 70235-116LF

Headerstraight, solder-to-board, page 25

- 1 module – part number 88951-101LF
- 2 modules – part number 88952-101LF
- 4 modules – part number 88953-101LF
- 8 modules – part number 88954-101LF

TYPICAL APPLICATIONS

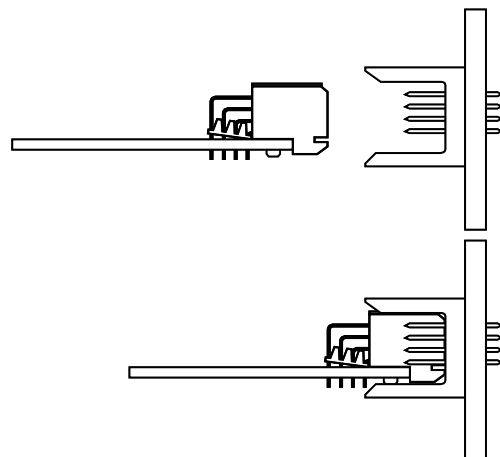

Receptacle, 4 row, signal, right angle, solder to board

PRODUCT

1 Module
89035-1yyLF

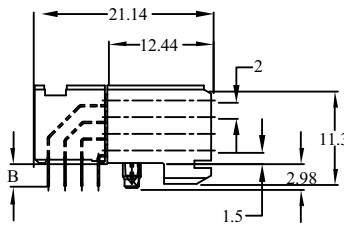
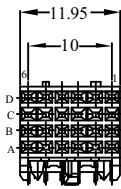

2 Module
89036-1yyLF

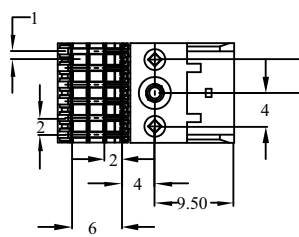
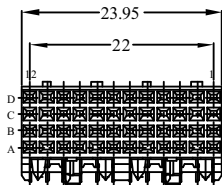

4 Module
89037-1yyLF

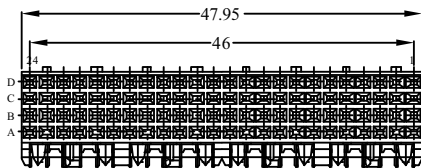

8 Module
89038-1yyLF

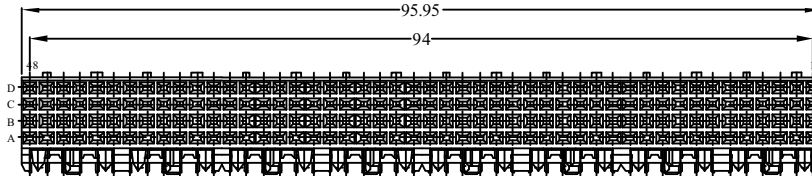

PCB pattern P1, see chapter PCB layouts

PARTNUMBERS

8903x - 1yyLF

Base Part Number

Performance

Pin Configuration

LF

89035 = 1 module (4 x 6 pos.)
89036 = 2 module (4 x 12 pos.)
89037 = 4 module (4 x 24 pos.)
89038 = 8 module (4 x 48 pos.)

1 = Telcordia CO

LF = lead free

yy	tail length (B)	PCB thickness
02	2,90 mm	1,60 mm
12	3,53 mm	2,40 mm

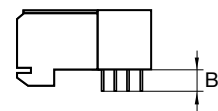

Receptacle, 4 row, signal, right angle, press fit

FEATURES

- In accordance with IEC 60917 and IEC 61076-4-104 (Futurebus+)
- 4 row and 2 mm pitch permit high signal density (200 contacts per 100mm connector length)
- Modular design guarantees flexibility
- Stackable end-to-end without loss of position
- Stackable with other METRAL® function modules (power, I/O)
- Reliable dual beam box contact
- Stable PCB fixation device
- Press block ensures accurate position of press-fit tails for easy mounting
- Eye the needle press-fit contact
- Low profile allows PCB spacing of 14mm



TECHNICAL DATA

PHYSICAL

- spacing: 2,00 mm x 2,00 mm
- housing: glass-filled LCP, colour natural
- flammability rating: UL 94 V-0
- contact material: phosphor bronze
- performance level: Telcordia CO

ELECTRICAL

- current rating: 1 A
- insulation resistance: 5x10³ MΩ initially, 1x10³ MΩ after tests
- withstanding voltage: 1000 V rms (sea level)

MECHANICAL PERFORMANCE

- insertion force: 0,45 N max. per individual signal contact (mating)
- withdrawal force: 0,15 N max. per individual signal contact (unmating)
- press-fit contact insertion: 55 N max. per pin
- press-fit pin withdrawal: 15 N min. per pin
- recommended hole diameter: 0,65-0,80 mm

ENVIRONMENTAL

- Operating temperature range: -55°C to +125°C
- RoHs information, this product is compatible according to the European Union Directive 2002/95/IEC

PACKAGING

- standard: tubes

PROCESSING INFORMATION

- press fit

REFERENCE DATA

- Press-peg application, TA-0941
- product specification.: GS-12-453

APPLICATION EQUIPMENT

- for application equipment, check out the application equipment table on page 217-223

MATING DATA

Header, straight, press-fit, page 27

- 1 module – part number 70232-116LF
- 2 modules – part number 70233-116LF
- 4 modules – part number 70234-116LF
- 8 modules – part number 70235-116LF

Header, straight, solder-to-board, page 25

- 1 module – part number 88951-101LF
- 2 modules – part number 88952-101LF
- 4 modules – part number 88953-101LF
- 8 modules – part number 88954-101LF

TYPICAL APPLICATIONS

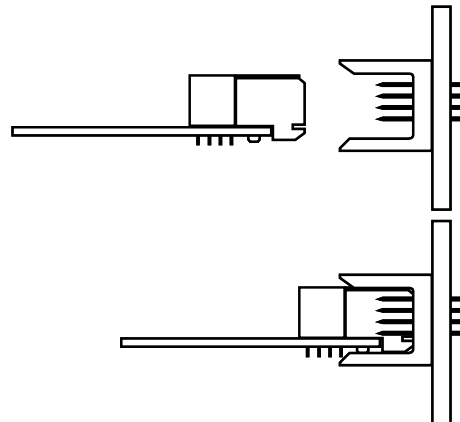

Receptacle, 4 row, signal, right angle, press fit

PRODUCT

1 Module
88945-1yyLF

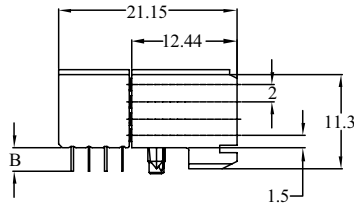
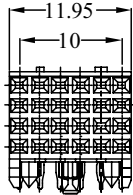

2 Module
88946-1yyLF

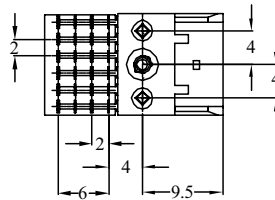
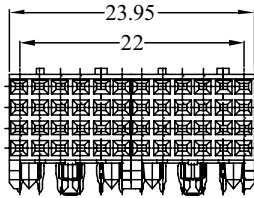

4 Module
88947-1yyLF

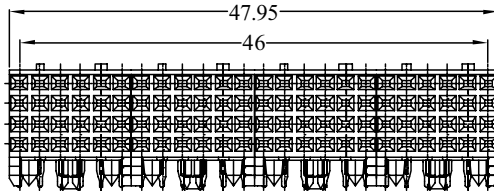

8 Module
88948-1yyLF

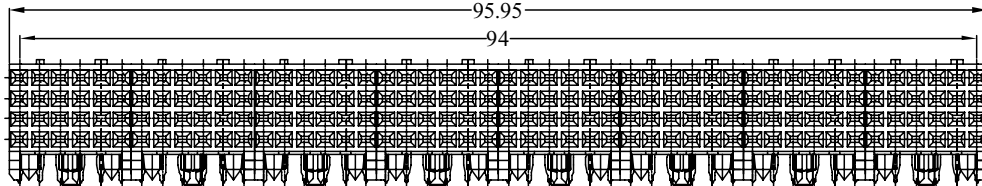

PCB pattern P1, see chapter PCB layouts

PARTNUMBERS

8894x - 1yyLF

Base Part Number

Performance

Pin Configuration

LF

88945 = 1 module (4 x 6 pos.)
88946 = 2 module (4 x 12 pos.)
88947 = 4 module (4 x 24 pos.)
88948 = 8 module (4 x 48 pos.)

1 = Telcordia CO

LF = lead free

yy	tail length (B)	PCB thickness
02	2,90 mm	1,60 mm
12	3,53 mm	2,40 mm

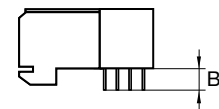

Note: blue marked in **pin configuration** is the preferred recommended standard
for other special patterns or loadings, please check drawings, all other configurations on request only

Receptacle, 4 row, signal, right angle, pin-in-paste

FEATURES

- In accordance with IEC 60917 and IEC 61076-4-104 (Futurebus+)
- 4 row and 2 mm pitch permit high signal density, 1 module (4 x 6 positions)
- Modular design guarantees flexibility
- Stackable end-to-end without loss of position
- Stackable with other METRAL® function modules (power, I/O)
- Tuning fork, forced controlled contact
- Stable PCB fixation device
- Low profile allows PCB spacing of 14mm



TECHNICAL DATA

PHYSICAL

- spacing: 2,00 mm x 2,00 mm
- housing: glass-filled LCP (30% glass), colour natural
- flammability rating: UL 94 V-0
- contact material: phosphor bronze
- performance level: Telcordia CO

ELECTRICAL

- current rating: 1 A
- insulation resistance: $5 \times 10^3 \text{ M}\Omega$ initially, $1 \times 10^3 \text{ M}\Omega$ after tests
- withstanding voltage: 1000 V rms (sea level)

MECHANICAL PERFORMANCE

- Maximum mounting force, 20 N per connector
- insertion force: 0,45 N max. per individual signal contact (mating)
- withdrawal force: 0,15 N max. per individual signal contact (unmating)
- Recommended hole diameter: 0,65 – 0,80 mm

ENVIRONMENTAL

- Operating temperature -55°C to + 125°C
- Max. temperature 260°C for 30 seconds
- RoHs information, this product is compatible according to the European Union Directive 2002/95/IEC

PACKAGING

- Tape&reel

PROCESSING INFORMATION

- Pick&place by vacuum nozzle or mechanical gripper
- automatic Surface-mount reflow process, resistance for Lead Free reflow temperature

REFERENCE DATA

- Product specification GS-12-215

APPLICATION EQUIPMENT

- for application equipment, check out the application equipment table on page 217-223

MATING DATA

- Header, straight, press-fit, page 27

- 1 module – part number 70232-116LF

- Header, straight, solder-to-board, page 25

- 1 module – part number 88951-101LF

TYPICAL APPLICATIONS

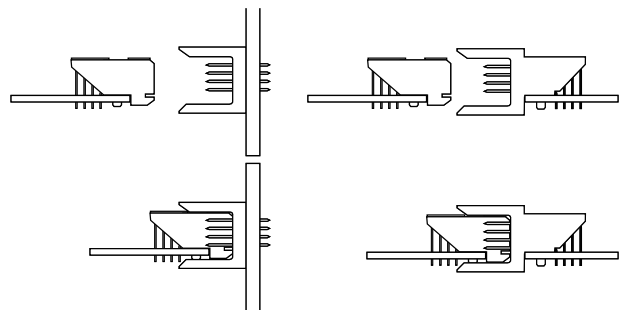

Receptacle, 4 row, signal, right angle, pin-in-paste

PRODUCT

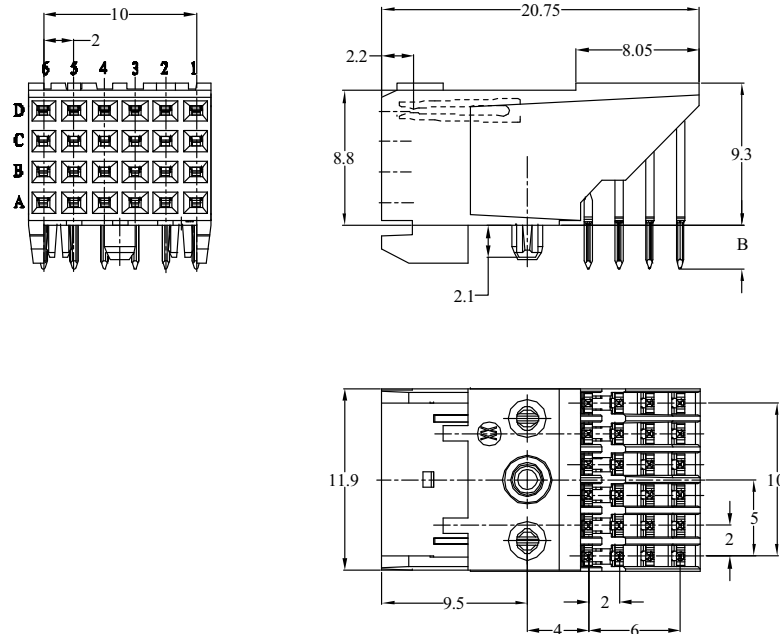

PCB pattern P1, see chapter PCB layouts

PARTNUMBERS

52048 - 1yyLF

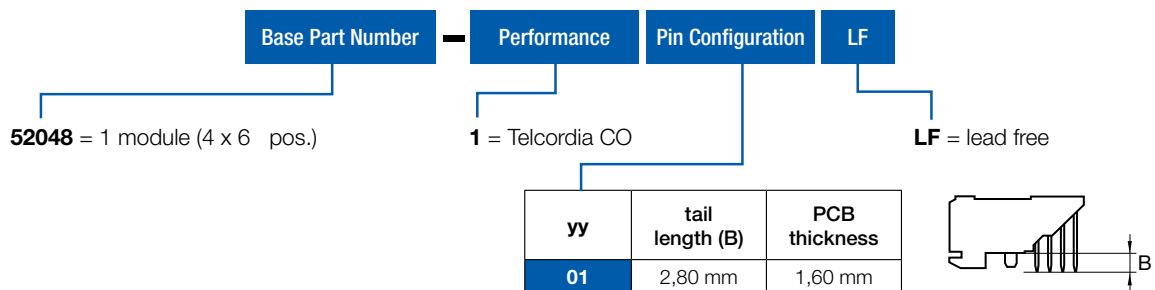

Note: blue marked in **pin configuration** is the preferred recommended standard
for other special patterns or loadings, please check drawings, all other configurations on request only

Header, 5 row, signal, straight, solder to board, wide body

FEATURES

- In accordance with IEC 60917 and IEC 61076-4-104 (Futurebus+)
- 5 Rows and 2 mm pitch permit high signal density (200 contacts per 100 mm connector length).
- Stackable end-to-end without loss of positions.
- Stackable with other METRAL™ function modules (e.g. power, coax, guide pin).
- First Make Last Break options.

TECHNICAL DATA

PHYSICAL

- spacing: 2,00 mm x 2,00 mm
- housing: glass-filled LCP, colour natural
- flammability rating: UL 94 V-0
- pin material: phosphor bronze
- performance level: Telcordia CO

ELECTRICAL

- current rating: 1 A
- insulation resistance: $5 \times 10^3 \text{ M}\Omega$ initially, $1 \times 10^3 \text{ M}\Omega$ after tests
- withstanding voltage: 1000 V rms (sea level)

MECHANICAL PERFORMANCE

- insertion force: 0,45 N max. per individual signal contact (mating)
- withdrawal force: 0,15 N max. per individual signal contact (unmating)
- recommended hole diameter: 0,65-0,80 mm

ENVIRONMENTAL

- Operating temperature range: -55°C to +125°C
- RoHs information, this product is compatible according to the European Union Directive 2002/95/IEC

PACKAGING

- standard: tubes

PROCESSING INFORMATION

- applicable soldering process: wave, IR, vapor phase

REFERENCE DATA

- product specification.: GS-12-180

APPLICATION EQUIPMENT

- for application equipment, check out the application equipment table on page 217-223



MATING DATA

Receptacle, right angle, press-fit, page 45

- 1 mod – part number 89047-102LF
- 2 mod – part number 89093-102LF
- 4 mod – part number 89094-102LF
- 8 mod – part number 89095-102LF

Receptacle, right angle, solder-to-board, page 43

- 1 mod – part numbers 85863-102LF
- 2 mod – part numbers 85864-102LF
- 4 mod – part numbers 85865-102LF
- 8 mod – part numbers 85866-102LF

TYPICAL APPLICATIONS

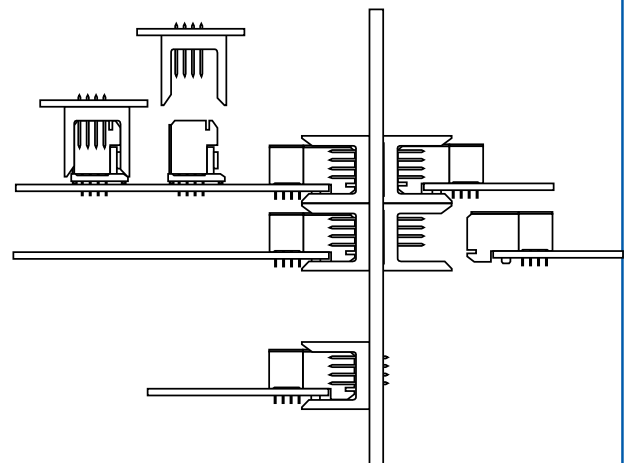

Header, 5 row, signal, straight, solder to board, wide body

PRODUCT

1 Module
74741-1yyLF

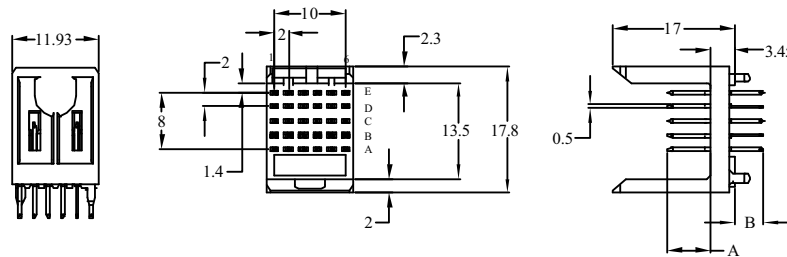

2 Module
7474x-1yyLF
on request only

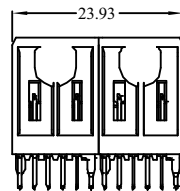

4 Module
7474x-1yyLF
on request only

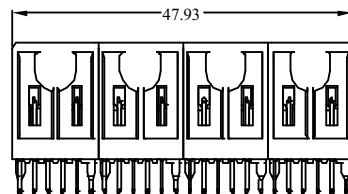

8 Module
7474x-1yyLF
on request only

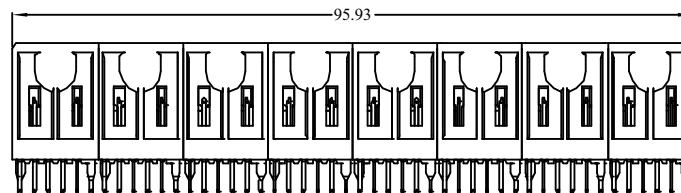

PCB pattern P16, see chapter PCB layouts

PARTNUMBERS

74741 - 1yyLF

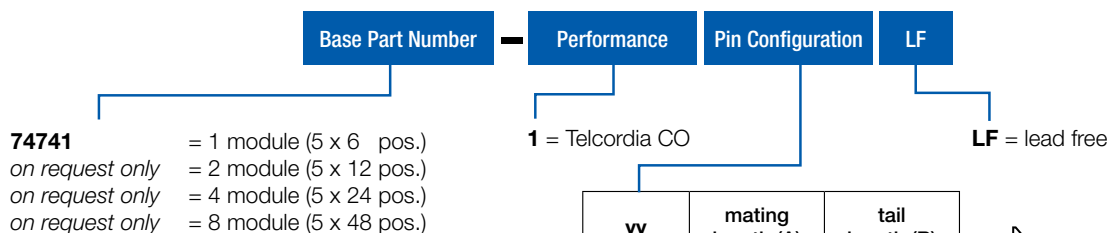

yy	mating length (A)	tail length (B)
63	5,00 mm	4,25 mm
01	6,50 mm	4,25 mm
79	5,00 mm	3,30 mm
31	6,50 mm	3,30 mm

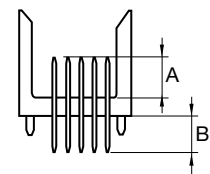

Note: for other special patterns or loadings, please check drawings, all other configurations on request only

Header, 5 row, signal, straight, press-fit, wide body

FEATURES

- In accordance with IEC 60917 and IEC 61076-4-104 (Futurebus+).
- 5 Rows and 2 mm pitch permit high signal density (200 contacts per 100 mm connector length).
- Stackable end-to-end without loss of positions.
- Stackable with other METRAL™ function modules (e.g. power, coax, guide pin).
- First Make Last Break options.
- Eye the needle press-fit contact

TECHNICAL DATA

PHYSICAL

- spacing: 2,00 mm x 2,00 mm
- housing: glass-filled LCP, colour natural
- flammability rating: UL 94 V-0
- pin material: phosphor bronze
- performance level: Telcordia CO

ELECTRICAL

- current rating: 1 A
- insulation resistance: $5 \times 10^3 \text{ M}\Omega$ initially, $1 \times 10^3 \text{ M}\Omega$ after tests
- withstanding voltage: 1000 V rms (sea level)

MECHANICAL PERFORMANCE

- insertion force: 0,45 N max. per individual signal contact (mating)
- withdrawal force: 0,15 N max. per individual signal contact (unmating)
- press-fit contact insertion: 65 N max. per pin
- press-fit pin withdrawal: 15 N min. per pin
- recommended hole diameter: 0,65-0,80 mm

ENVIRONMENTAL

- Operating temperature range: -55°C to +125°C
- RoHs information, this product is compatible according to the European Union Directive 2002/95/IEC

PACKAGING

- standard: tubes

PROCESSING INFORMATION

- press fit

REFERENCE DATA

- product specification.: GS-12-180

APPLICATION EQUIPMENT

- for application equipment, check out the application equipment table on page 217-223



MATING DATA

■ Receptacle, right angle, press-fit, page 45

- 1 mod – part number 89047-102LF
- 2 mod – part number 89093-102LF
- 4 mod – part number 89094-102LF
- 8 mod – part number 89095-102LF

■ Receptacle, right angle, solder-to-board, page 43

- 1 mod – part numbers 85863-102LF
- 2 mod – part numbers 85864-102LF
- 4 mod – part numbers 85865-102LF
- 8 mod – part numbers 85866-102LF

TYPICAL APPLICATIONS

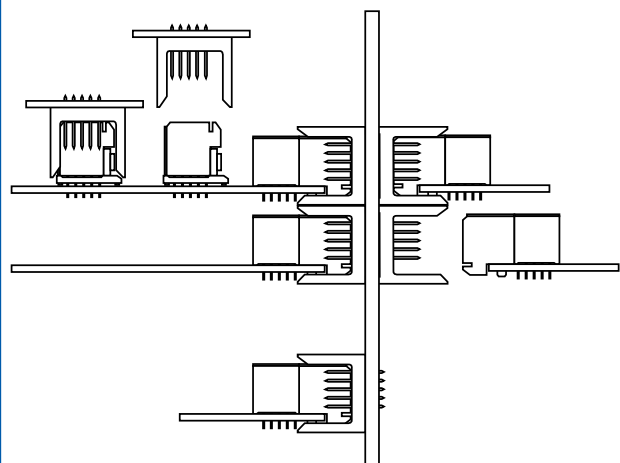

Header, 5 row, signal, straight, press-fit, wide body

PRODUCT

1 Module
89006-1yyLF

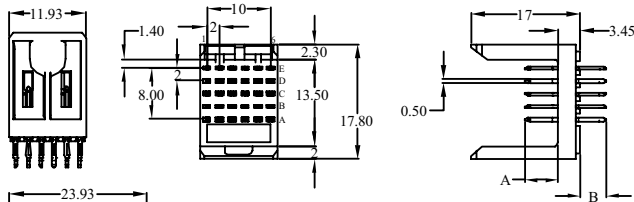

2 Module
89007-1yyLF

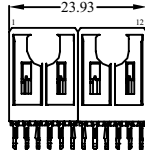

4 Module
89008-1yyLF

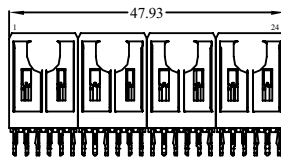

8 Module
89009-1yyLF

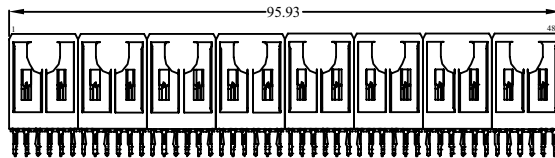

PCB pattern P7, see chapter PCB layouts

PARTNUMBERS

8900x - 1yyLF

Base Part Number

Performance

Pin Configuration

LF

89006 = 1 module (5 x 6 pos.)
89007 = 2 module (5 x 12 pos.)
89008 = 4 module (5 x 24 pos.)
89009 = 8 module (5 x 48 pos.)

1 = Telcordia CO

LF = lead free

yy	mating length (A)	tail length (B)
11	5,00 mm	4,30 mm
16	5,75 mm	4,30 mm
15	6,50 mm	4,30 mm
21	5,00 mm	13,60 mm
26	5,75 mm	13,60 mm
25	6,50 mm	13,60 mm
first-make last-brake 44	row A = 5,00 mm	4,30 mm
	row B = 6,50 mm	4,30 mm
	row C = 7,25 mm	4,30 mm
	row D = 6,50 mm	4,30 mm
	row E = 5,00 mm	4,30 mm

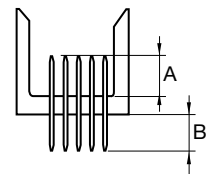

Note: blue marked in **pin configuration** is the preferred recommended standard
for other special patterns or loadings, please check drawings, all other configurations on request only

Receptacle, 5 row, signal, right angle, solder to board

FEATURES

- In accordance with IEC 60917 and IEC 61076-4-104 (Futurebus+)
- 5 row and 2 mm pitch permit high signal density (250 contacts per 100 mm connector length)
- Modular design guarantees flexibility
- Stackable end-to-end without loss of position
- Stackable with other METRAL® function modules (power, I/O)
- Reliable dual beam box contact
- Stable PCB fixation device

TECHNICAL DATA

PHYSICAL

- spacing: 2,00 mm x 2,00 mm
- housing: glass-filled LCP, colour natural
- flammability rating: UL 94 V-0
- contact material: phosphor bronze
- performance level: Telcordia CO

ELECTRICAL

- current rating: 1 A
- insulation resistance: 5x10³ MΩ initially, 1x10³ MΩ after tests
- withstanding voltage: 1000 V rms (sea level)

MECHANICAL PERFORMANCE

- insertion force: 0,45 N max. per individual signal contact (mating)
- withdrawal force: 0,15 N max. per individual signal contact (unmating)
- Recommended hole diameter: 0,65 – 0,80 mm

ENVIRONMENTAL

- Operating temperature range: -55°C to +125°C
- RoHs information, this product is compatible according to the European Union Directive 2002/95/IEC

PACKAGING

- standard: tubes

PROCESSING INFORMATION

- Applicable process: wave, IR, vapor phase

REFERENCE DATA

- Press-peg application, TA-0941
- product specification.: GS-12-453

APPLICATION EQUIPMENT

- for application equipment, check out the application equipment table on page 217-223



MATING DATA

Header straight, press-fit, page 41

- 1 module – part number 89006-116LF
- 2 modules – part number 89007-116LF
- 4 modules – part number 89008-116LF
- 8 modules – part number 89009-116LF

Header straight, solder-to-board, page 39

- 1 module – part number 74741-101LF
- 2 modules – on request only
- 4 modules – on request only
- 8 modules – on request only

TYPICAL APPLICATIONS

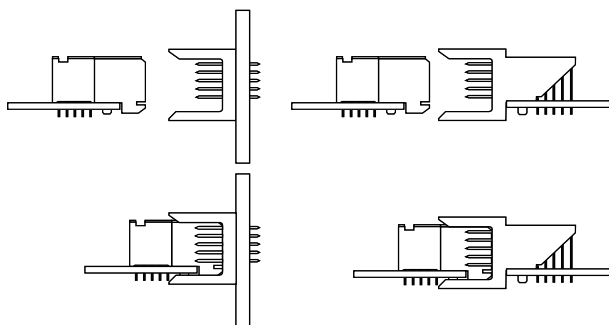

Receptacle, 5 row, signal, right angle, solder to board

PRODUCT

1 Module
85863-1yyLF

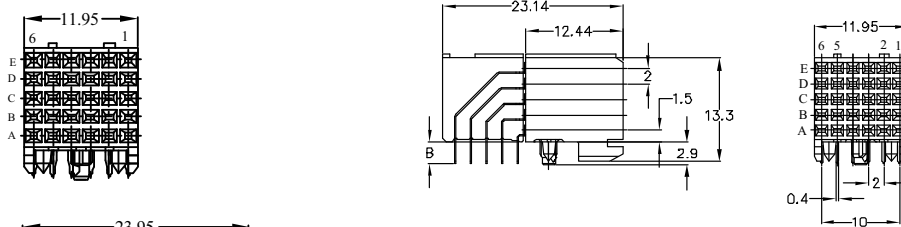

2 Module
85864-1yyLF

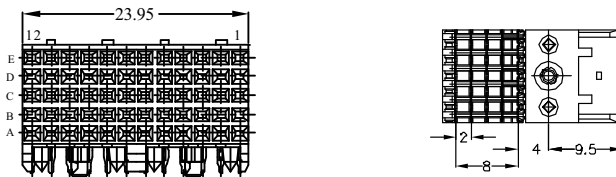

4 Module
85865-1yyLF

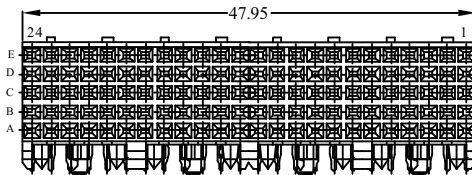

8 Module
85866-1yyLF

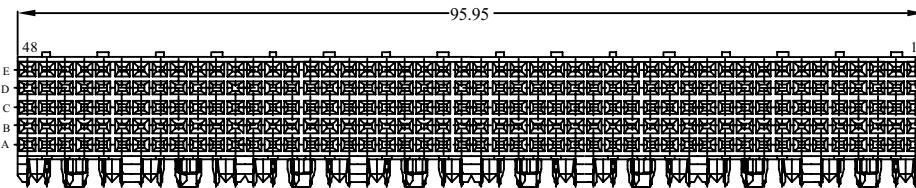

PCB pattern P2, see chapter PCB layouts

PARTNUMBERS

8586x - 1yyLF

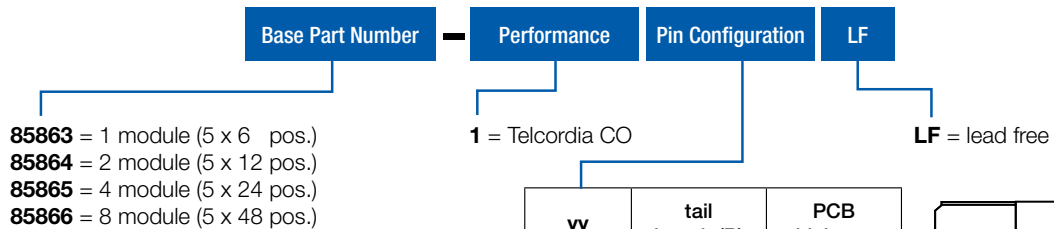

yy	tail length (B)	PCB thickness
02	2,90 mm	1,60 mm
12	3,53 mm	2,40 mm

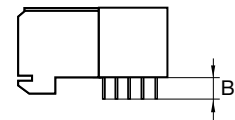

Receptacle, 5 row, signal, right angle, press fit

FEATURES

- In accordance with IEC 60917 and IEC 61076-4-104 (Futurebus+)
- 5 row and 2 mm pitch permit high signal density (250 contacts per 100 mm connector length)
- Modular design guarantees flexibility
- Stackable end-to-end without loss of position
- Stackable with other METRAL® function modules (power, I/O)
- Reliable dual beam box contact
- Stable PCB fixation device
- Press block ensures accurate position of press-fit tails for easy mounting
- Eye the needle press-fit contact



TECHNICAL DATA

PHYSICAL

- spacing: 2,00 mm x 2,00 mm
- housing: glass-filled LCP, colour natural
- flammability rating: UL 94 V-0
- contact material: phosphor bronze
- performance level: Telcordia CO

ELECTRICAL

- current rating: 1 A
- insulation resistance: 5x10³ MΩ initially, 1x10³ MΩ after tests
- withstanding voltage: 1000 V rms (sea level)

MECHANICAL PERFORMANCE

- insertion force: 0,45 N max. per individual signal contact (mating)
- withdrawal force: 0,15 N max. per individual signal contact (unmating)

- press-fit contact insertion: 55 N max. per pin
- press-fit pin withdrawal: 15 N min. per pin
- recommended hole diameter: 0,65-0,80 mm

ENVIRONMENTAL

- Operating temperature range: -55°C to +125°C
- RoHs information, this product is compatible according to the European Union Directive 2002/95/IEC

PACKAGING

- standard: tubes

PROCESSING INFORMATION

- press fit

REFERENCE DATA

- Press-peg application, TA-0941
- product specification.: GS-12-453

APPLICATION EQUIPMENT

- for application equipment, check out the application equipment table on page 217-223.

MATING DATA

Header straight, press-fit, page 41

- 1 module – part number 89006-116LF
- 2 modules – part number 89007-116LF
- 4 modules – part number 89008-116LF
- 8 modules – part number 89009-116LF

Header straight, solder-to-board, page 39

- 1 module – part number 74741-101LF
- 2 modules – *on request only*
- 4 modules – *on request only*
- 8 modules – *on request only*

TYPICAL APPLICATIONS

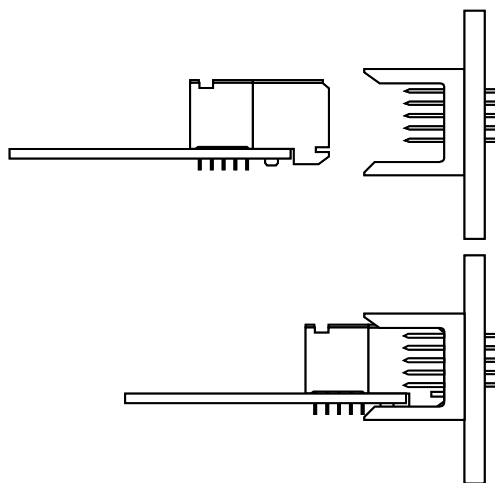

Receptacle, 5 row, signal, right angle, press fit

PRODUCT

1 Module
89047-1yyLF

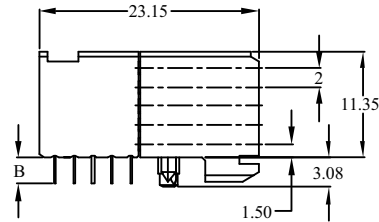
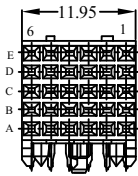

2 Module
89093-1yyLF

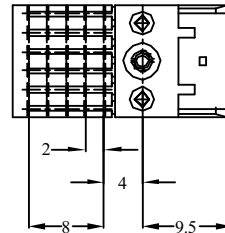
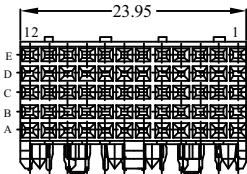

4 Module
89094-1yyLF

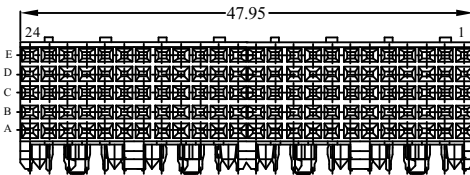

8 Module
89095-1yyLF

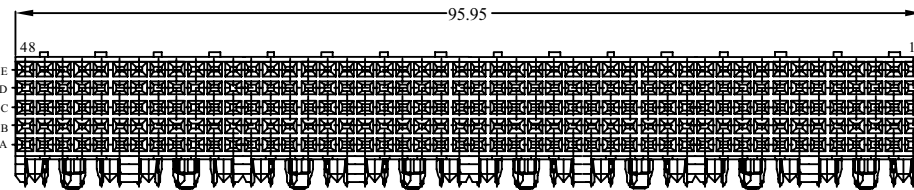

PCB pattern P2, see chapter PCB layouts

PARTNUMBERS

8904x - 1yyLF

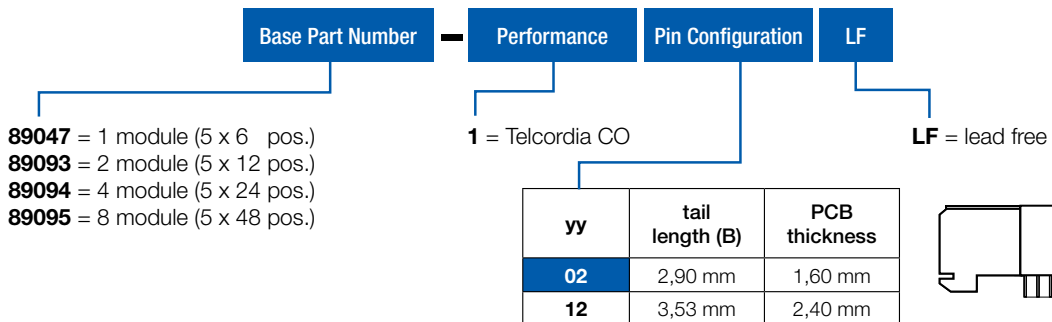

Note: blue marked in **pin configuration** is the preferred recommended standard
for other special patterns or loadings, please check drawings, all other configurations on request only

Receptacle, 5 row, signal, right angle, pin-in-paste

FEATURES

- In accordance with IEC 60917 and IEC 61076-4-104 (Futurebus+)
- 5 row and 2 mm pitch permit high signal density, 1 module (5 x 6 positions)
- Modular design guarantees flexibility
- Stackable end-to-end without loss of position
- Stackable with other METRAL® function modules (power, I/O)
- Tuning fork, forced controlled contact
- Stable PCB fixation device
- Low profile allows PCB spacing of 14mm



TECHNICAL DATA

PHYSICAL

- spacing: 2,00 mm x 2,00 mm
- housing: glass-filled LCP (30% glass), colour natural
- flammability rating: UL 94 V-0
- contact material: phosphor bronze
- performance level: Telcordia CO

ELECTRICAL

- current rating: 1 A
- insulation resistance: $5 \times 10^3 \text{ M}\Omega$ initially, $1 \times 10^3 \text{ M}\Omega$ after tests
- withstanding voltage: 1000 V rms (sea level)

MECHANICAL PERFORMANCE

- Maximum mounting force, 20 N per connector
- insertion force: 0,45 N max. per individual signal contact (mating)
- withdrawal force: 0,15 N max. per individual signal contact (unmating)
- Recommended hole diameter: 0,65 – 0,80 mm

ENVIRONMENTAL

- Operating temperature -55°C to + 125°C
- Max. temperature 260°C for 30 seconds
- RoHs information, this product is compatible according to the European Union Directive 2002/95/IEC

PACKAGING

- Tape&reel

PROCESSING INFORMATION

- Pick&place by vacuum nozzle or mechanical gripper
- automatic Surface-mount reflow process, resistance for Lead Free reflow temperature

REFERENCE DATA

- Product specification GS-12-215

APPLICATION EQUIPMENT

- for application equipment, check out the application equipment table on page 217-223

MATING DATA

- Header, straight, press-fit, page 41

- 1 module – part number 89006-116LF

- Header, straight, solder-to-board, page 39

- 1 module – part number 74741-101LF

TYPICAL APPLICATIONS

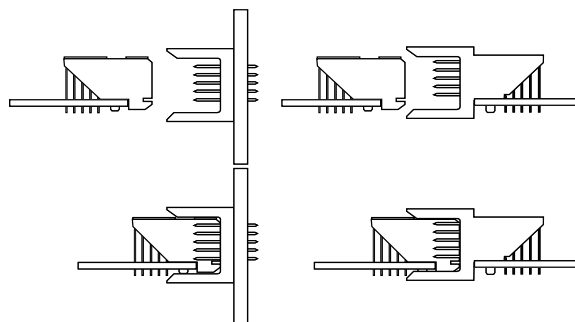

Receptacle, 5 row, signal, right angle, pin-in-paste

PRODUCT

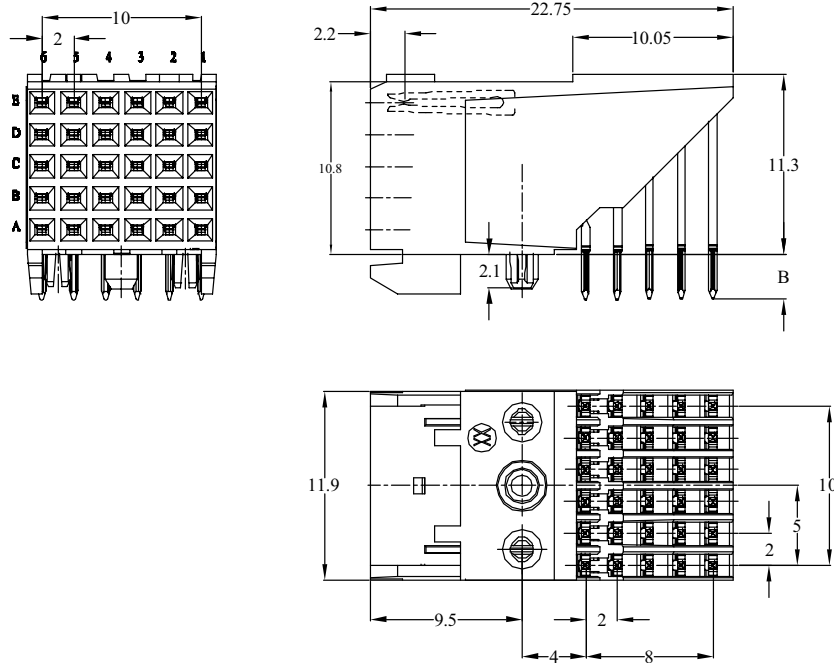

PCB pattern P2, see chapter PCB layouts

PARTNUMBERS

52049 - 101LF

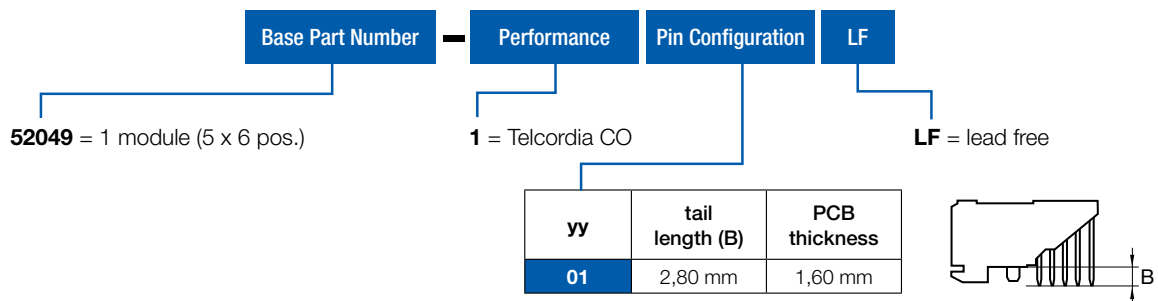

Note: blue marked in **pin configuration** is the preferred recommended standard for other special patterns or loadings, please check drawings, all other configurations on request only

Header, 8 row, signal, straight, press fit, wide body

FEATURES

- In accordance with IEC 60917 and IEC 61076-4-104 (Futurebus+)
- 8 row and 2 mm pitch permit high signal density (800 contacts per 100mm connector length)
- 2 modules header, 8 rows by 6 position
- Baby H-shape press-fit contact

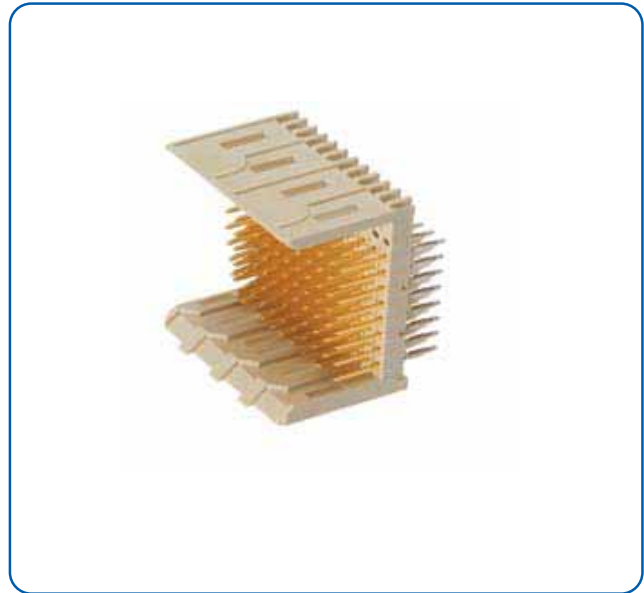

TECHNICAL DATA

PHYSICAL

- spacing: 2,00 mm x 2,00 mm
- housing: glass-filled LCP, colour natural
- flammability rating: UL 94 V-0
- pin material: phosphor bronze
- performance level: Telcordia CO

ELECTRICAL

- current rating: 1 A
- insulation resistance: 5x10³ MΩ initially, 1x10³ MΩ after tests
- withstanding voltage: 1000 V rms (sea level)

MECHANICAL PERFORMANCE

- insertion force: 0,45 N max. per individual signal contact (mating)
- withdrawal force: 0,15 N max. per individual signal contact (unmating)

- press-fit contact insertion: 65 N max. per pin
- press-fit pin withdrawal: 15 N min. per pin
- recommended hole diameter: 0,65-0,80 mm

ENVIRONMENTAL

- Operating temperature range: -55°C to +125°C
- RoHs information, this product is compatible according to the European Union Directive 2002/95/IEC

PACKAGING

- standard: tubes

PROCESSING INFORMATION

- press fit

REFERENCE DATA

- product specification.: GS-12-134
- application specification: GS-20-010

APPLICATION EQUIPMENT

- for application equipment, check out the application equipment table on page 217-223

MATING DATA

- Receptacle, right angle, press-fit, page 51
- part number 74770-102LF

TYPICAL APPLICATIONS

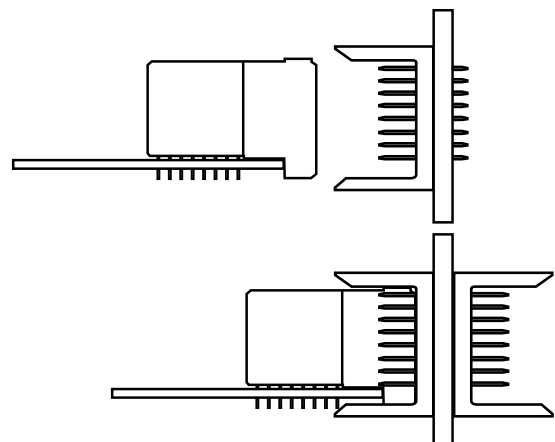

Header, 8 row, signal, straight, press fit, wide body

PRODUCT

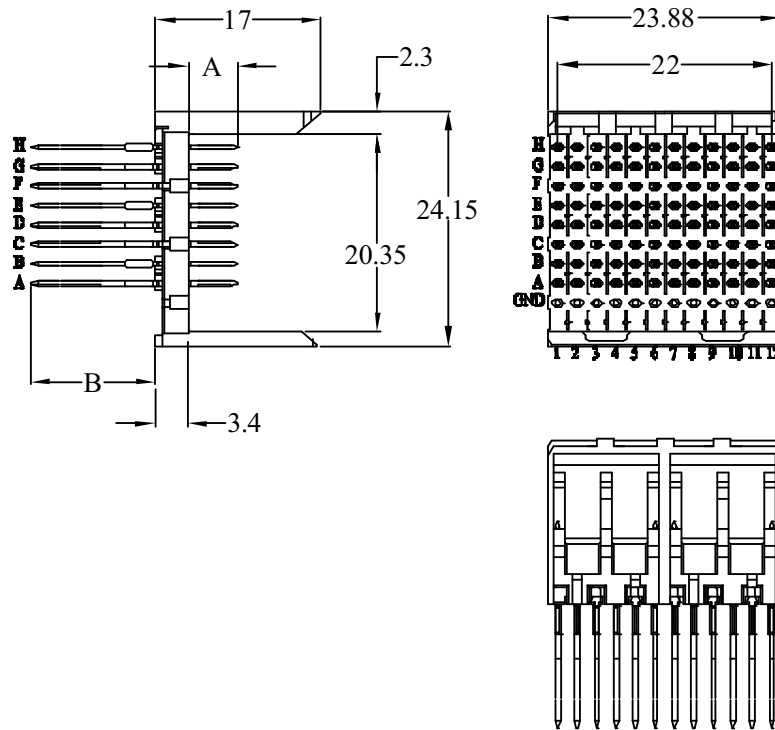

PCB pattern P21, see chapter PCB layouts

PARTNUMBERS

74771 - 102011LF

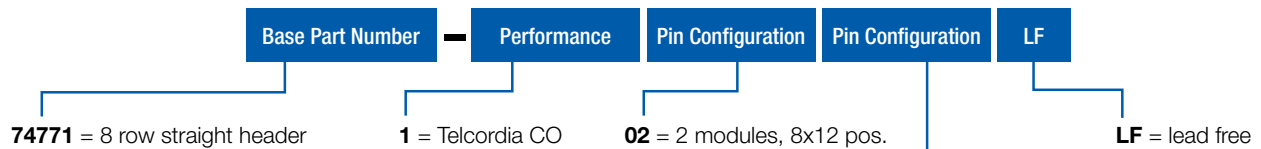

yyy	mating length (A)	tail length (B)
011	6,50 mm	17,10 mm

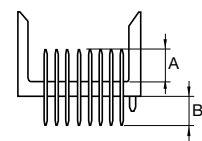

Note: blue marked in **pin configuration** is the preferred recommended standard
for other special patterns or loadings, please check drawings, all other configurations on request only

Receptacle, 8 row, signal, right angle, press fit

FEATURES

- In accordance with IEC 60917 and IEC 61076-4-104 (Futurebus+)
- 8 row and 2 mm pitch permit high signal density (800 contacts per 100mm connector length)
- 2 modules header, 8 rows by 6 position
- Eye of the needle press-fit contact
- Tuning fork, forced controlled contact

TECHNICAL DATA

PHYSICAL

- spacing: 2,00 mm x 2,00 mm
- housing: glass-filled LCP, colour natural
- flammability rating: UL 94 V-0
- pin material: phosphor bronze
- performance level: Telcordia CO

ELECTRICAL

- current rating: 1 A
- insulation resistance: $5 \times 10^3 \text{ M}\Omega$ initially, $1 \times 10^3 \text{ M}\Omega$ after tests
- withstanding voltage: 1000 V rms (sea level)

MECHANICAL PERFORMANCE

- insertion force: 0,45 N max. per individual signal contact (mating)
- withdrawal force: 0,15 N max. per individual signal contact (unmating)
- press-fit contact insertion: 55 N max. per pin
- press-fit pin withdrawal: 15 N min. per pin
- recommended hole diameter: 0,65-0,80 mm

ENVIRONMENTAL

- Operating temperature range: -55°C to $+125^\circ\text{C}$
- RoHs information, this product is compatible according to the European Union Directive 2002/95/IEC

PACKAGING

- standard: tubes

PROCESSING INFORMATION

- press fit

REFERENCE DATA

- product spec.: GS-12-134
- application specification: GS-20-010

APPLICATION EQUIPMENT

- for application equipment, check out the application equipment table on page 217-223



MATING DATA

- Receptacle, right angle, press-fit, page 49
- part number 74771-102011LF

TYPICAL APPLICATIONS

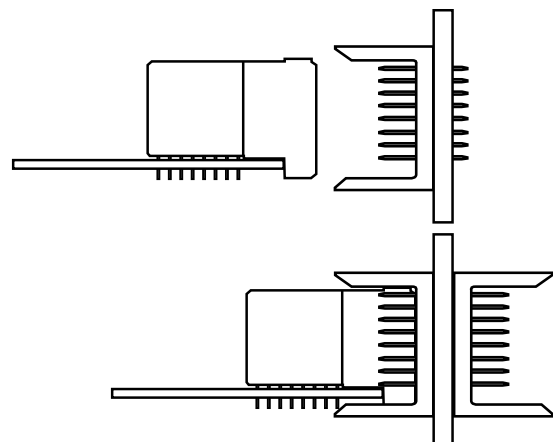

Receptacle, 8 row, signal, right angle, press fit

PRODUCT

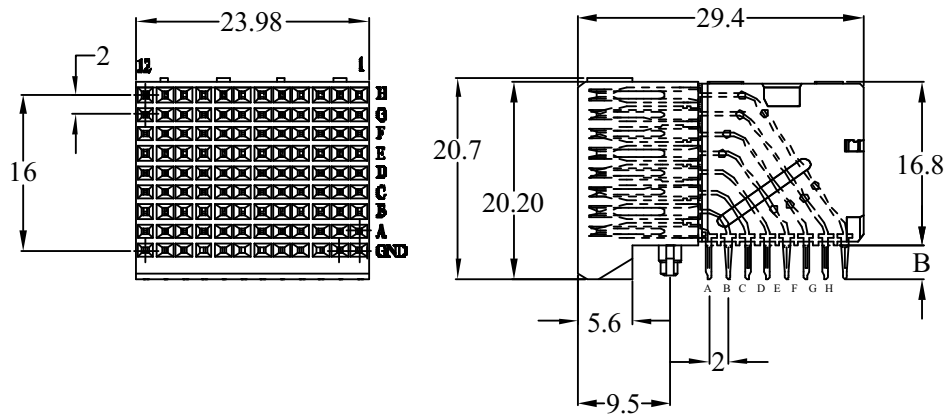

PCB pattern P22, see chapter PCB layouts

PARTNUMBERS

74770 - 102LF

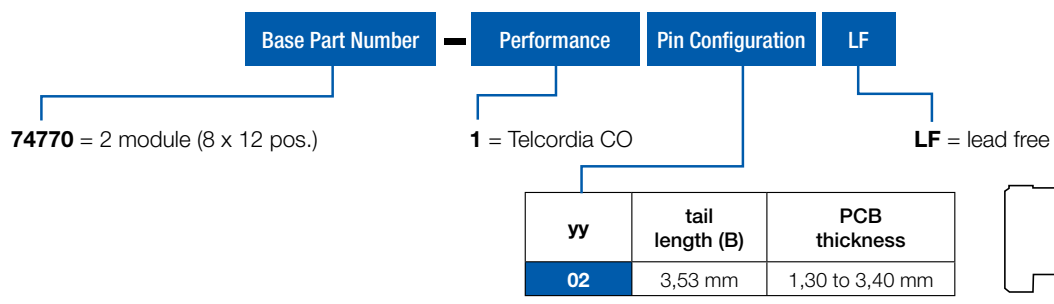

Note: blue marked in **pin configuration** is the preferred recommended standard
for other special patterns or loadings, please check drawings, all other configurations on request only



■ METRAL® SIGNAL CONNECTORS REVERSED

- Header, 4 row, right angle, wide body
- Header, 4 row, right angle, narrow body
- Receptacle, 4 row, straight
- Header, 5 row, right angle, wide body
- Header, 5 row, right angle, narrow body
- Receptacle, 4 row, straight

Header, 4 row, signal, right angle, solder to board, wide body

FEATURES

- In accordance with IEC 60917 and IEC 61076-4-104 (Futurebus+)
- 4 row and 2 mm pitch permit high signal density (200 contacts per 100mm connector length)
- Modular design guarantees flexibility

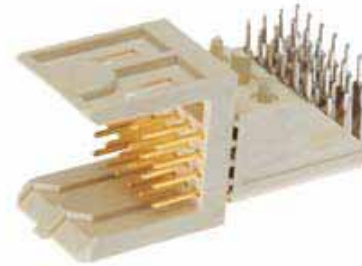

TECHNICAL DATA

PHYSICAL

- spacing: 2,00 mm x 2,00 mm
- housing: glass-filled LCP, colour natural
- flammability rating: UL 94 V-0
- pin material: phosphor bronze
- performance level: Telcordia CO

ELECTRICAL

- current rating: 1 A
- insulation resistance: 5×10^3 M Ω initially, 1×10^3 M Ω after tests
- withstanding voltage: 1000 V rms (sea level)

MECHANICAL PERFORMANCE

- insertion force: 0,45 N max. per individual signal contact (mating)
- withdrawal force: 0,15 N max. per individual signal contact (unmating)
- recommended hole diameter: 0,65-0,80 mm

ENVIRONMENTAL

- Operating temperature range: -55°C to +125°C
- RoHs information, this product is compatible according to the European Union Directive 2002/95/IEC

PACKAGING

- standard: trays

PROCESSING INFORMATION

- applicable soldering process: wave, IR, vapor phase

REFERENCE DATA

- Product specification: GS-12-446

APPLICATION EQUIPMENT

- for application equipment, check out the application equipment table on page 217-223

MATING DATA

Receptacle, straight, press-fit, page 69

- 1 mod – part number 85757-1101LF
- 2 mod – part number 85758-1101LF
- 4 mod – part number 85759-1101LF
- 8 mod – part number 85760-1101LF

Receptacle, straight, solder-to-board, page 67

- 1 mod – part numbers HM1S41FRR000H6PLF
- 2 mod – part numbers HM1S42FRR000H6PLF
- 4 mod – part numbers HM1S43FRR000H6PLF
- 8 mod – part numbers HM1S44FRR000H6PLF

TYPICAL APPLICATIONS

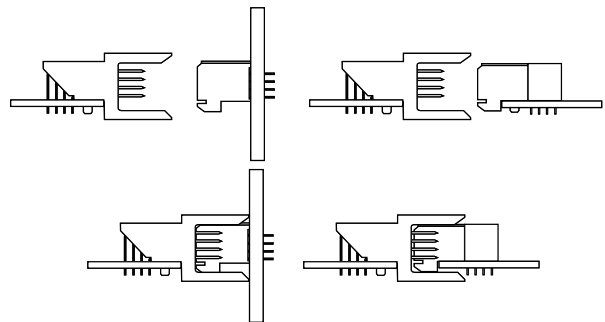

Header, 4 row, signal, right angle, solder to board, wide body

PRODUCT

1 Module

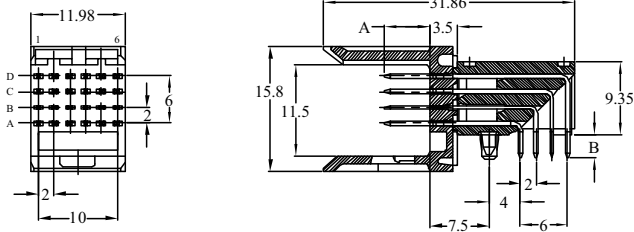

2 Module

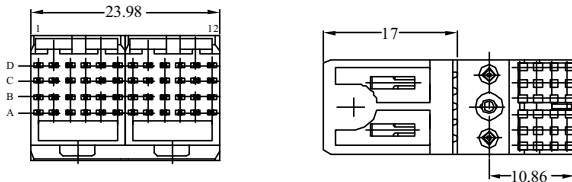

4 Module

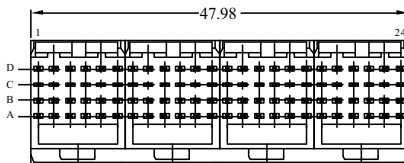

8 Module

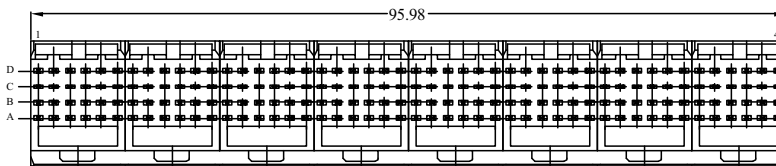

PCB pattern P1, see chapter PCB layouts

PARTNUMBERS

HM1L4 x LAP000H6PLF

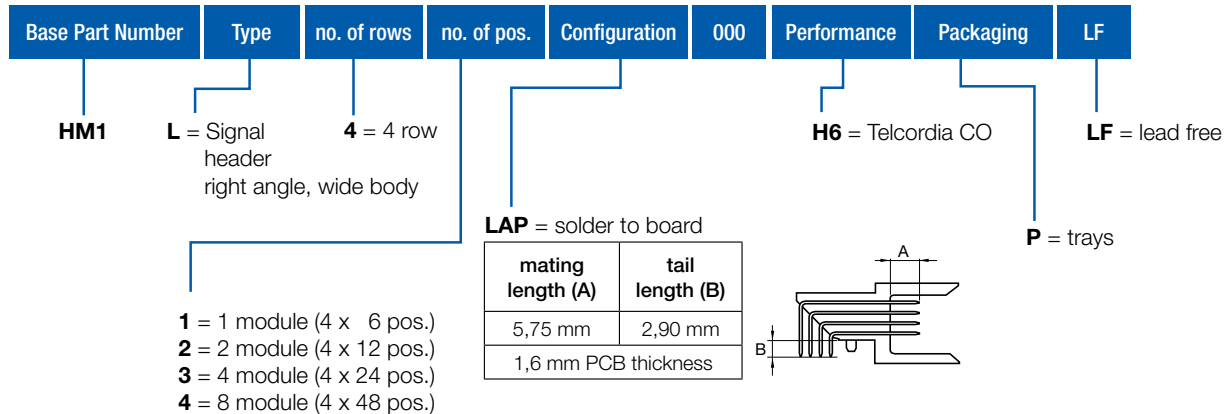

Note: For other special patterns or loadings, please check drawings, all other configurations on request only

Header, 4 row, signal, right angle, press fit, wide body

FEATURES

- In accordance with IEC 60917 and IEC 61076-4-104 (Futurebus+)
- 4 row and 2 mm pitch permit high signal density (200 contacts per 100mm connector length)
- Modular design guarantees flexibility
- Eye of the needle press-fit contact

TECHNICAL DATA

PHYSICAL

- spacing: 2,00 mm x 2,00 mm
- housing: glass-filled LCP, colour natural
- flammability rating: UL 94 V-0
- pin material: phosphor bronze
- performance level: Telcordia CO

ELECTRICAL

- current rating: 1 A
- insulation resistance: $5 \times 10^3 \text{ M}\Omega$ initially, $1 \times 10^3 \text{ M}\Omega$ after tests
- withstanding voltage: 1000 V rms (sea level)

MECHANICAL PERFORMANCE

- insertion force: 0,45 N max. per individual signal contact (mating)
- withdrawal force: 0,15 N max. per individual signal contact (unmating)
- press-fit contact insertion: 55 N max. per pin
- press-fit pin withdrawal: 15 N min. per pin
- recommended hole diameter: 0,65-0,80 mm

ENVIRONMENTAL

- Operating temperature range: -55°C to +125°C
- RoHs information, this product is compatible according to the European Union Directive 2002/95/IEC

PACKAGING

- standard: trays

PROCESSING INFORMATION

- press-fit

REFERENCE DATA

- Product specification: GS-12-445

APPLICATION EQUIPMENT

- for application equipment, check out the application equipment table on page 217-223

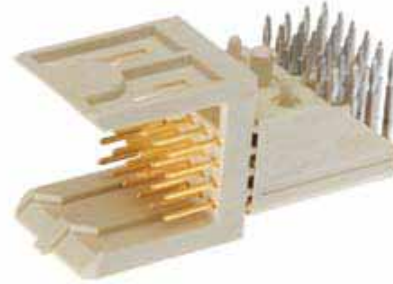

MATING DATA

Receptacle, press-fit, page 69

- 1 mod – part number 85757-1101LF
- 2 mod – part number 85758-1101LF
- 4 mod – part number 85759-1101LF
- 8 mod – part number 85760-1101LF

Receptacle, solder-to-board, page 67

- 1 mod – part numbers HM1S41FRR000H6PLF
- 2 mod – part numbers HM1S42FRR000H6PLF
- 4 mod – part numbers HM1S43FRR000H6PLF
- 8 mod – part numbers HM1S44FRR000H6PLF

TYPICAL APPLICATIONS

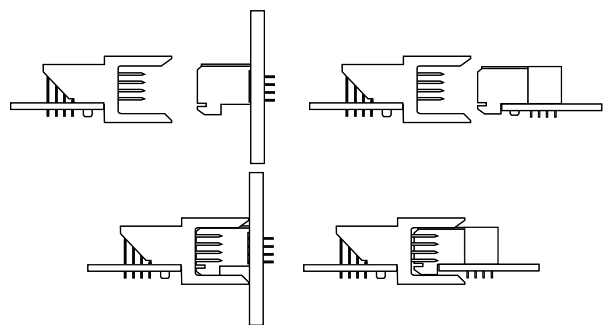

Header, 4 row, signal, right angle, press fit, wide body

PRODUCT

1 Module

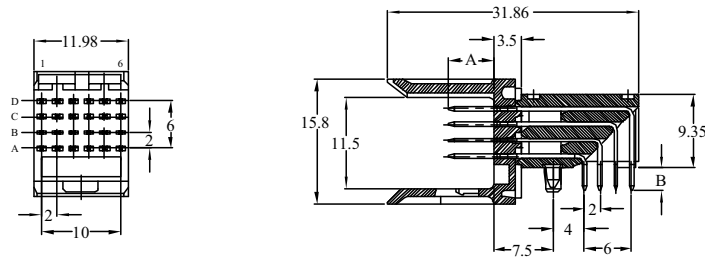

2 Module

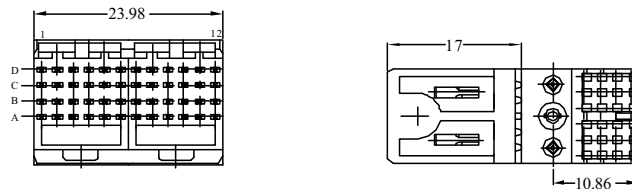

4 Module

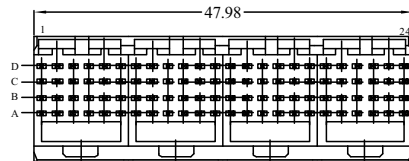

8 Module

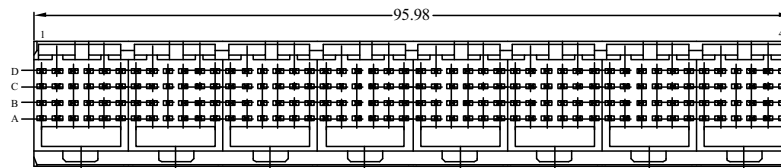

PCB pattern P1, see chapter PCB layouts

PARTNUMBERS

HM1L4 x LDP000H6PLF

Base Part Number	Type	no. of rows	no. of pos.	Configuration	000	Performance	Packaging	LF						
HM1	L = Signal header right angle, wide body	4 = 4 row	LDP = Press fit	<table border="1"> <thead> <tr> <th>mating length (A)</th> <th>tail length (B)</th> </tr> </thead> <tbody> <tr> <td>5,75 mm</td> <td>2,90 mm</td> </tr> <tr> <td colspan="2">1,6 mm PCB thickness</td> </tr> </tbody> </table>	mating length (A)	tail length (B)	5,75 mm	2,90 mm	1,6 mm PCB thickness			H6 = Telcordia CO	P = trays	LF = lead free
mating length (A)	tail length (B)													
5,75 mm	2,90 mm													
1,6 mm PCB thickness														
		1 = 1 module (4 x 6 pos.) 2 = 2 module (4 x 12 pos.) 3 = 4 module (4 x 24 pos.) 4 = 8 module (4 x 48 pos.)												

Note: for other special patterns or loadings, please check drawings, all other configurations on request only

Header, 4 row, signal, right angle, pin-in-paste, wide body

FEATURES

- In accordance with IEC 60917 and IEC 61076-4-104 (Futurebus+)
- 4 row and 2 mm pitch permit high signal density (200 contacts per 100mm connector length)
- Modular design guarantees flexibility

TECHNICAL DATA

PHYSICAL

- spacing: 2,00 mm x 2,00 mm
- housing: glass-filled LCP, colour natural
- flammability rating: UL 94 V-0
- pin material: phosphor bronze
- performance level: Telcordia CO

ELECTRICAL

- current rating: 1 A
- insulation resistance: $5 \times 10^3 \text{ M}\Omega$ initially, $1 \times 10^3 \text{ M}\Omega$ after tests
- withstanding voltage: 1000 V rms (sea level)

MECHANICAL PERFORMANCE

- insertion force: 0,45 N max. per individual signal contact (mating)
- withdrawal force: 0,15 N max. per individual signal contact (unmating)
- recommended hole diameter: 0,65-0,80 mm

ENVIRONMENTAL

- Operating temperature range: -55°C to +125°C
- RoHs information, this product is compatible according to the European Union Directive 2002/95/IEC

PACKAGING

- standard: trays

PROCESSING INFORMATION

- Pick&place by vacuum nozzle or mechanical gripper
- automatic Surface-mount reflow process, resistance for Lead Free reflow temperature

REFERENCE DATA

- Product specification: GS-12-446

APPLICATION EQUIPMENT

- for application equipment, check out the application equipment table on page 217-223

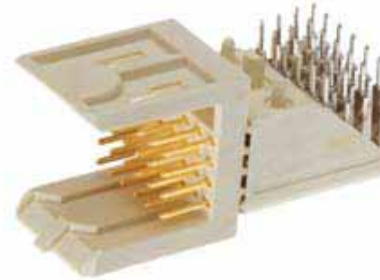

MATING DATA

Receptacle, straight, press-fit, page 69

- 1 mod – part number 85757-101LF

Receptacle, straight, solder-to-board, page 67

- 1 mod – part numbers HM1S41FRR000H6PLF

TYPICAL APPLICATIONS

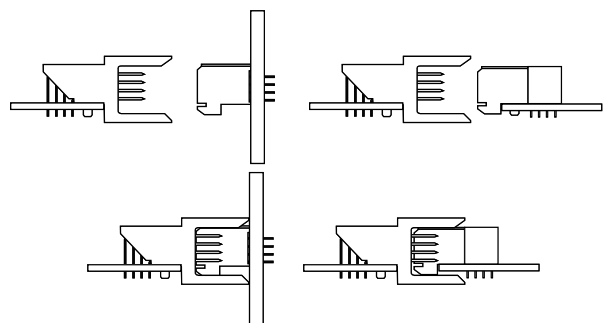

Header, 4 row, signal, right angle, pin-in-paste, wide body

PRODUCT

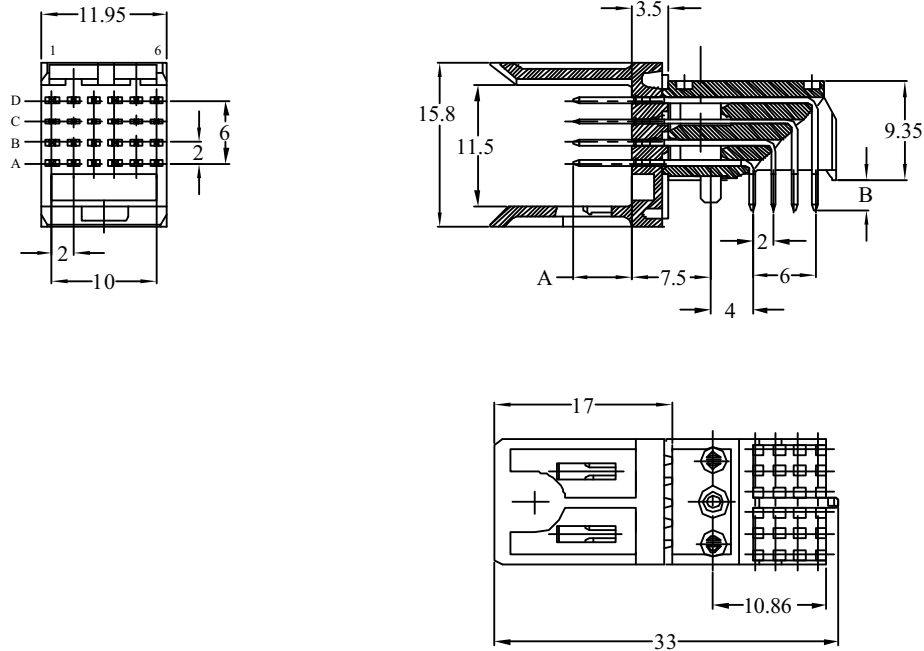

PCB pattern P1, see chapter PCB layouts

PARTNUMBERS

HM1L4 x LFP00H6PLF

Base Part Number	Type	no. of rows	no. of pos.	Configuration	000	Performance	Packaging	LF						
HM1	L = Signal header right angle, wide body	4 = 4 row	1	LFP = Pin-in-Paste <table border="1"> <thead> <tr> <th>mating length (A)</th> <th>tail length (B)</th> </tr> </thead> <tbody> <tr> <td>5,75 mm</td> <td>2,90 mm</td> </tr> <tr> <td colspan="2">1,6 mm PCB thickness</td> </tr> </tbody> </table>	mating length (A)	tail length (B)	5,75 mm	2,90 mm	1,6 mm PCB thickness			H6 = Telcordia CO	P = trays	LF = lead free
mating length (A)	tail length (B)													
5,75 mm	2,90 mm													
1,6 mm PCB thickness														
				1 = 1 module (4 x 6 pos.)										

Note: for other special patterns or loadings, please check drawings, all other configurations on request only

Header, 4 row, signal, right angle, solder to board, narrow body

FEATURES

- In accordance with IEC 60917 and IEC 61076-4-104 (Futurebus+)
- 4 row and 2 mm pitch permit high signal density (200 contacts per 100mm connector length)
- Modular design guarantees flexibility
- Narrow body housing

TECHNICAL DATA

PHYSICAL

- spacing: 2,00 mm x 2,00 mm
- housing: glass-filled LCP, colour natural
- flammability rating: UL 94 V-0
- pin material: phosphor bronze
- performance level: Telcordia CO

ELECTRICAL

- current rating: 1 A
- insulation resistance: $5 \times 10^3 \text{ M}\Omega$ initially, $1 \times 10^3 \text{ M}\Omega$ after tests
- withstanding voltage: 1000 V rms (sea level)

MECHANICAL PERFORMANCE

- insertion force: 0,45 N max. per individual signal contact (mating)
- withdrawal force: 0,15 N max. per individual signal contact (unmating)
- recommended hole diameter: 0,65-0,80 mm

ENVIRONMENTAL

- Operating temperature range: -55°C to $+125^\circ\text{C}$
- RoHs information, this product is compatible according to the European Union Directive 2002/95/IEC

PACKAGING

- standard: tubes

PROCESSING INFORMATION

- applicable soldering process: wave, IR, vapor phase

REFERENCE DATA

- Product specification: GS-12-446

APPLICATION EQUIPMENT

- for application equipment, check out the application equipment table on page 217-223



MATING DATA

- Receptacle, straight, press-fit, page 69
 - 1 mod – part number 85757-1101LF
- Receptacle, straight, solder-to-board, page 67
 - 1 mod – part numbers HM1S41FRR000H6PLF

TYPICAL APPLICATIONS

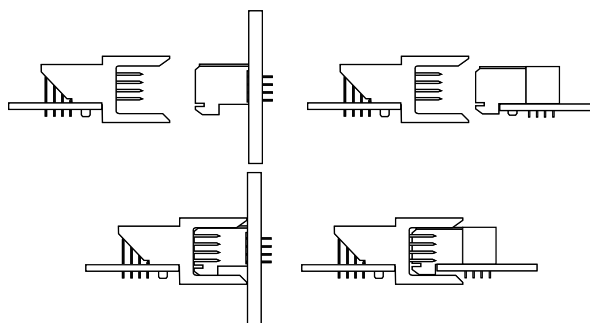

Header, 4 row, signal, right angle, solder to board, narrow body

PRODUCT

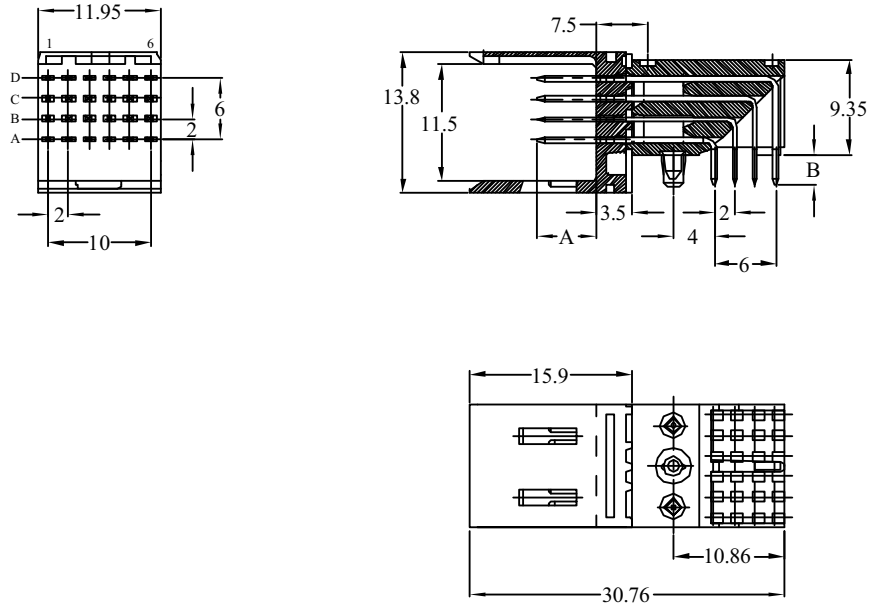

PCB pattern P1, see chapter PCB layouts

PARTNUMBERS

85822 - 1yyLF

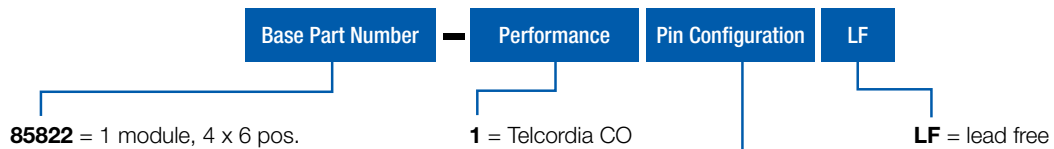

yy	mating length (A)	tail length (B)
01	5,00 mm	2,90 mm
05	5,75 mm	2,90 mm
10	5,75 mm	3,70 mm

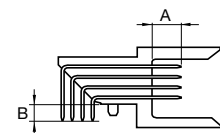

Note: for other special patterns or loadings, please check drawings, all other configurations on request only

Header, 4 row, signal, right angle, press fit, narrow body

FEATURES

- In accordance with IEC 60917 and IEC 61076-4-104 (Futurebus+)
- 5 row and 2 mm pitch permit high signal density (250 contacts per 100mm connector length)
- Modular design guarantees flexibility
- Narrow body housing
- Eye of the needle press-fit contact



TECHNICAL DATA

PHYSICAL

- spacing: 2,00 mm x 2,00 mm
- housing: glass-filled LCP, colour natural
- flammability rating: UL 94 V-0
- pin material: phosphor bronze
- performance level: Telcordia CO

ELECTRICAL

- current rating: 1 A
- insulation resistance: 5×10^3 M Ω initially, 1×10^3 M Ω after tests
- withstanding voltage: 1000 V rms (sea level)

MECHANICAL PERFORMANCE

- insertion force: 0,45 N max. per individual signal contact (mating)
- withdrawal force: 0,15 N max. per individual signal contact (unmating)
- press-fit contact insertion: 55 N max. per pin
- press-fit pin withdrawal: 15 N min. per pin
- recommended hole diameter: 0,65-0,80 mm

ENVIRONMENTAL

- Operating temperature range: -55°C to +125°C
- RoHs information, this product is compatible according to the European Union Directive 2002/95/IEC

PACKAGING

- standard: tubes

PROCESSING INFORMATION

- press fit

REFERENCE DATA

- Product specification: GS-12-445

APPLICATION EQUIPMENT

- for application equipment, check out the application equipment table on page 217-223

MATING DATA

Receptacle, straight, press-fit, page 69

- 1 mod – part number 85757-1101LF

Receptacle, straight, solder-to-board, page 67

- 1 mod – part numbers HM1S41FRR000H6PLF

TYPICAL APPLICATIONS

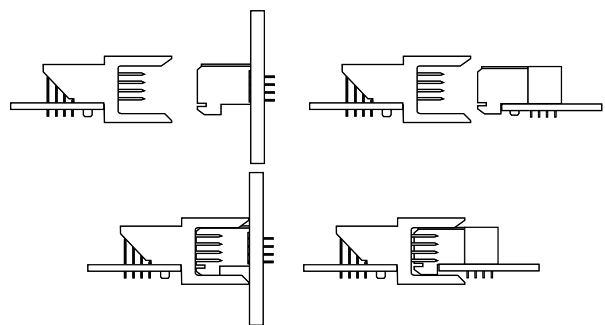

Header, 4 row, signal, right angle, press fit, narrow body

PRODUCT

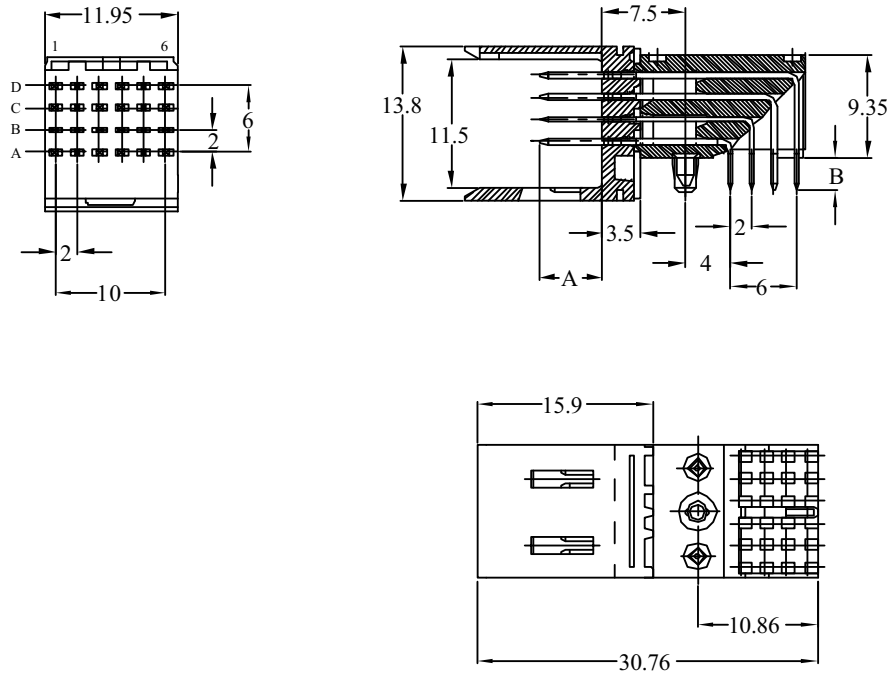

PCB pattern P1, see chapter PCB layouts

PARTNUMBERS

58363 - 1yyLF

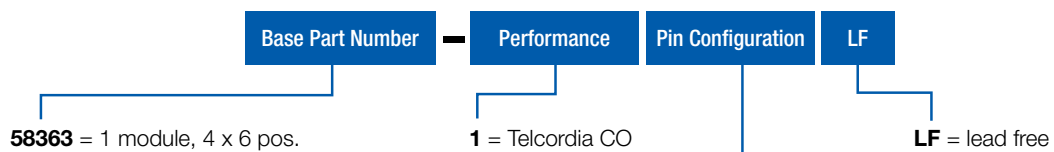

yy	mating length (A)	tail length (B)
01	5,00 mm	2,90 mm
05	5,75 mm	2,90 mm

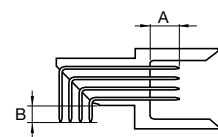

Note: for other special patterns or loadings, please check drawings, all other configurations on request only

Header, 4 row, signal, right angle, pin-in-paste, narrow body

FEATURES

- In accordance with IEC 60917 and IEC 61076-4-104 (Futurebus+)
- 4 row and 2 mm pitch permit high signal density (200 contacts per 100mm connector length)
- Modular design guarantees flexibility
- Narrow body housing

TECHNICAL DATA

PHYSICAL

- spacing: 2,00 mm x 2,00 mm
- housing: glass-filled LCP, colour natural
- flammability rating: UL 94 V-0
- pin material: phosphor bronze
- performance level: Telcordia CO

ELECTRICAL

- current rating: 1 A
- insulation resistance: $5 \times 10^3 \text{ M}\Omega$ initially, $1 \times 10^3 \text{ M}\Omega$ after tests
- withstanding voltage: 1000 V rms (sea level)

MECHANICAL PERFORMANCE

- insertion force: 0,45 N max. per individual signal contact (mating)
- withdrawal force: 0,15 N max. per individual signal contact (unmating)
- recommended hole diameter: 0,65-0,80 mm

ENVIRONMENTAL

- Operating temperature range: -55°C to +125°C
- RoHs information, this product is compatible according to the European Union Directive 2002/95/IEC

PACKAGING

- standard: tape&reel

PROCESSING INFORMATION

- Pick&place by vacuum nozzle or mechanical gripper
- automatic Surface-mount reflow process, resistance for Lead Free reflow temperature

REFERENCE DATA

- Product specification: GS-12-446

APPLICATION EQUIPMENT

- for application equipment, check out the application equipment table on page 217-223

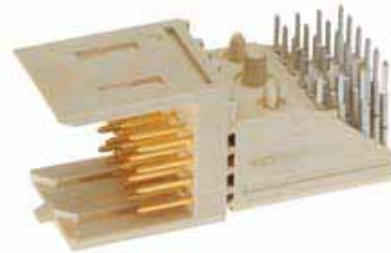

MATING DATA

Receptacle, straight, press-fit, page 69

- 1 mod – part number 85757-1101LF

Receptacle, straight, solder-to-board, page 67

- 1 mod – part numbers HM1S41FRR000H6PLF

TYPICAL APPLICATIONS

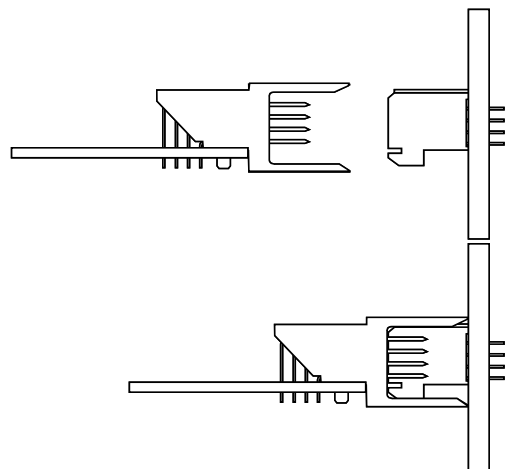

Header, 4 row, signal, right angle, pin-in-paste, narrow body

PRODUCT

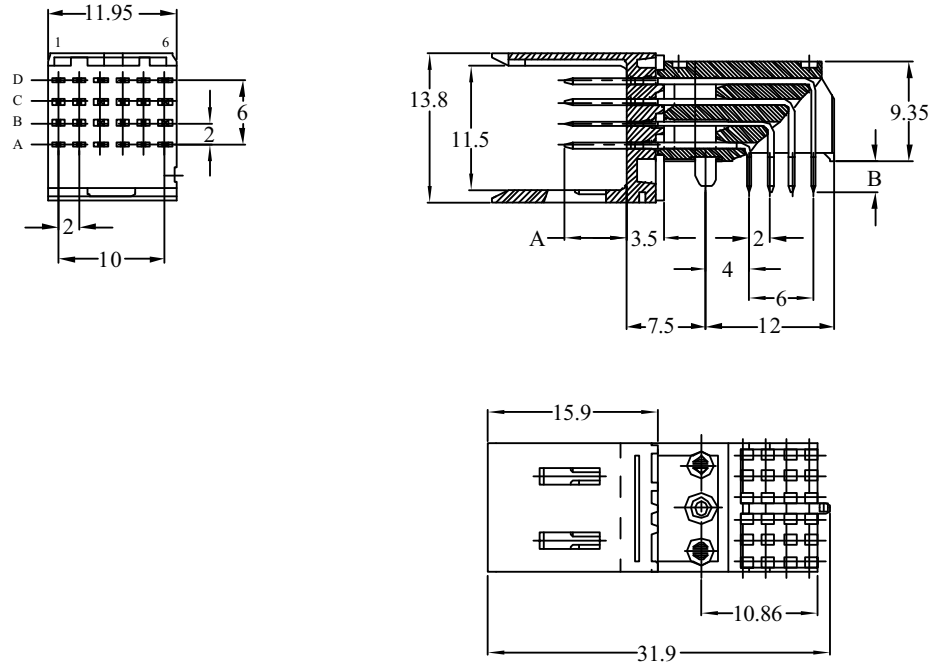

PCB pattern P1, see chapter PCB layouts

PARTNUMBERS

58361 - 101LF

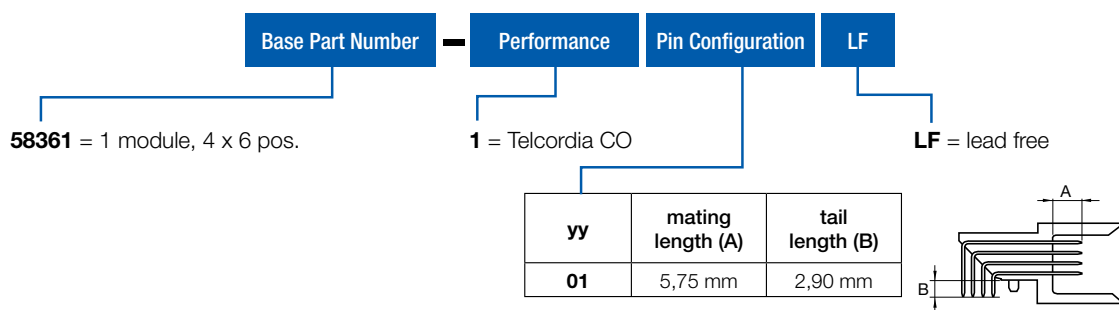

Note: for other special patterns or loadings, please check drawings, all other configurations on request only

Receptacle, 4 row, signal, straight, solder to board

FEATURES

- In accordance with IEC 60917 and IEC 61076-4-104 (Futurebus+)
- 4 row and 2 mm pitch permit high signal density (200 contacts per 100mm connector length)
- Modular design guarantees flexibility
- Parallel board applications
- Tuning fork contact

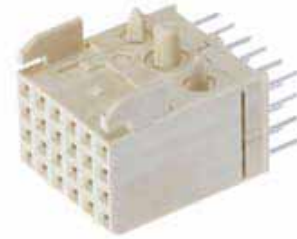

TECHNICAL DATA

PHYSICAL

- spacing: 2,00 mm x 2,00 mm
- housing: glass-filled LCP, colour natural
- flammability rating: UL 94 V-0
- contact material: phosphor bronze
- performance level: Telcordia CO

ELECTRICAL

- current rating: 1 A
- insulation resistance: 5×10^3 M Ω initially, 1×10^3 M Ω after tests
- withstanding voltage: 1000 V rms (sea level)

MECHANICAL PERFORMANCE

- insertion force: 0,45 N max. per individual signal contact (mating)
- withdrawal force: 0,15 N max. per individual signal contact (unmating)
- recommended hole diameter: 0,65-0,80 mm

ENVIRONMENTAL

- Operating temperature range: -55°C to +125°C
- RoHS information, this product is compatible according to the European Union Directive 2002/95/IEC

PACKAGING

- standard: trays

PROCESSING INFORMATION

- Applicable process: wave, IR, vapor phase

REFERENCE DATA

- Product specification: GS-12-448

APPLICATION EQUIPMENT

- for application equipment, check out the application equipment table on page 217-223

MATING DATA

Header, right angle, press-fit, page 57

- 1 module-part number HM1L41LDP000H6PLF
- 2 module-part number HM1L42LDP000H6PLF
- 4 module-part number HM1L43LDP000H6PLF
- 8 module-part number HM1L44LDP000H6PLF

Header, right angle, solder-to-board, page 55

- 1 module-part number HM1L41LAP000H6PLF
- 2 module-part number HM1L42LAP000H6PLF
- 4 module-part number HM1L43LAP000H6PLF
- 8 module-part number HM1L44LAP000H6PLF

Header, right angle, Pin-in-Paste, page 59

- 1 module-part number HM1L41LFP000H6PLF

TYPICAL APPLICATIONS

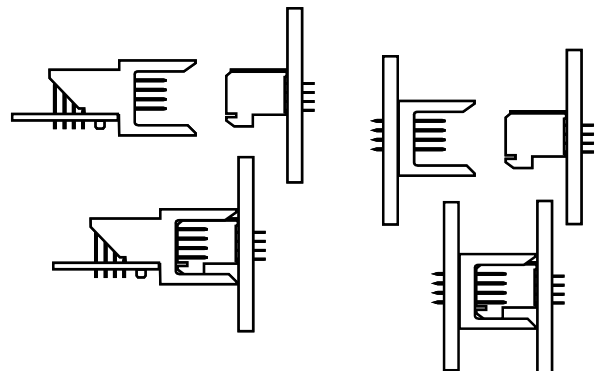

Receptacle, 4 row, signal, straight, solder to board

PRODUCT

1 Module

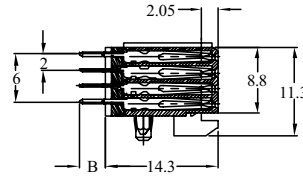
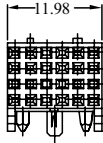

2 Module

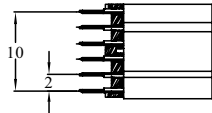
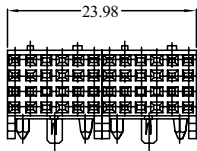

4 Module

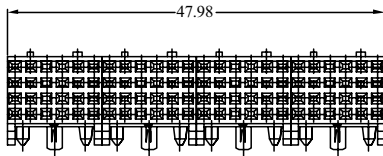

8 Module

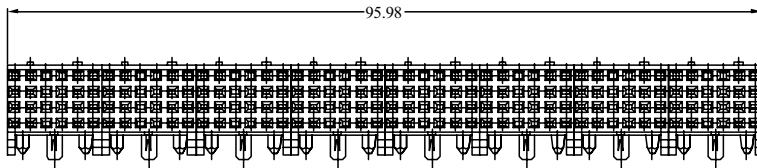

PCB pattern P5, see chapter PCB layouts

PARTNUMBERS

HM1S4 x FRR000H6PLF

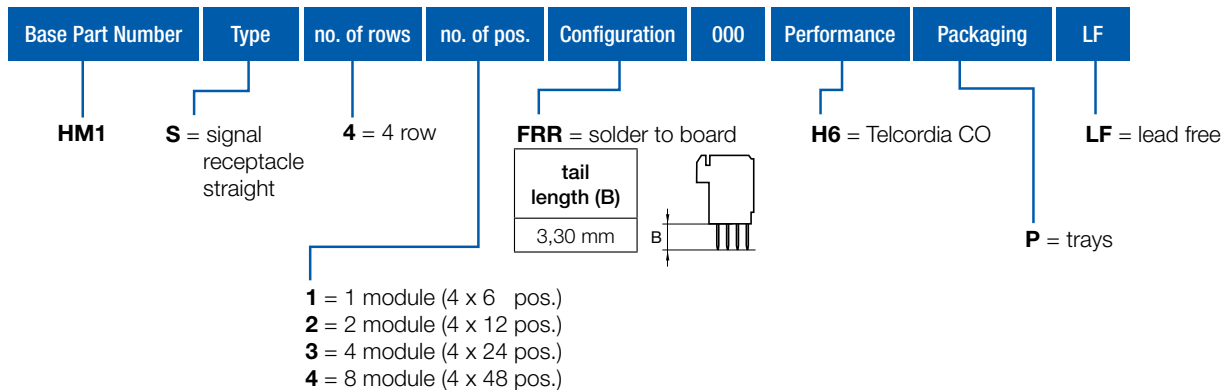

Note: for other special patterns or loadings, please check drawings, all other configurations on request only

Receptacle, 4 row, signal, straight, press fit

FEATURES

- In accordance with IEC 60917 and IEC 61076-4-104 (Futurebus+)
- 4 row and 2 mm pitch permit high signal density (200 contacts per 100mm connector length)
- Modular design guarantees flexibility
- Parallel board applications
- Tuning fork contact
- Baby H-shape press-fit contact
- Flat rock design; can be pressed on PCB with flat press block



TECHNICAL DATA

PHYSICAL

- spacing: 2,00 mm x 2,00 mm
- housing: glass-filled LCP, colour natural
- flammability rating: UL 94 V-0
- contact material: phosphor bronze
- performance level: Telcordia CO

ELECTRICAL

- current rating: 1 A
- insulation resistance: $5 \times 10^3 \text{ M}\Omega$ initially, $1 \times 10^3 \text{ M}\Omega$ after tests
- withstanding voltage: 1000 V rms (sea level)

MECHANICAL PERFORMANCE

- insertion force: 0,45 N max. per individual signal contact (mating)
- withdrawal force: 0,15 N max. per individual signal contact (unmating)
- press-fit contact insertion: 100 N max. per pin
- press-fit pin withdrawal: 20 N min. per pin
- recommended hole diameter: 0,65-0,80 mm

ENVIRONMENTAL

- Operating temperature range: -55°C to +125°C
- RoHS information, this product is compatible according to the European Union Directive 2002/95/IEC

PACKAGING

- standard: tubes

PROCESSING INFORMATION

- press fit

REFERENCE DATA

- Product specification: GS-12-447

APPLICATION EQUIPMENT

- for application equipment, check out the application equipment table on page 217-223

MATING DATA

Header, right angle, press-fit, page 57

- 1 module-part number HM1L41LDP000H6PLF
- 2 module-part number HM1L42LDP000H6PLF
- 4 module-part number HM1L43LDP000H6PLF
- 8 module-part number HM1L44LDP000H6PLF

Header, right angle, solder-to-board, page 55

- 1 module-part number HM1L41LAP000H6PLF
- 2 module-part number HM1L42LAP000H6PLF
- 4 module-part number HM1L43LAP000H6PLF
- 8 module-part number HM1L44LAP000H6PLF

Header, right angle, Pin-in-Paste, page 59

- 1 module-part number HM1L41LFP000H6PLF

TYPICAL APPLICATIONS

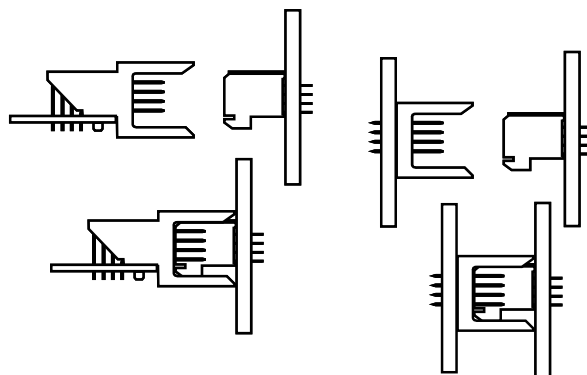

Receptacle, 4 row, signal, straight, press fit

PRODUCT

1 Module

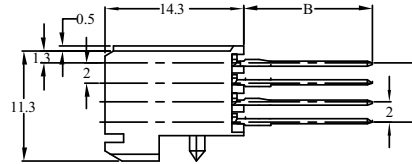
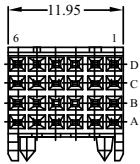

2 Module

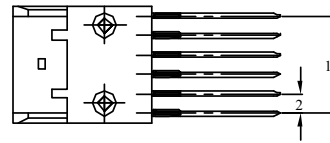
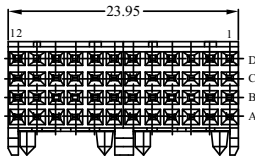

4 Module

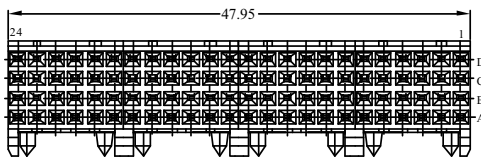

8 Module

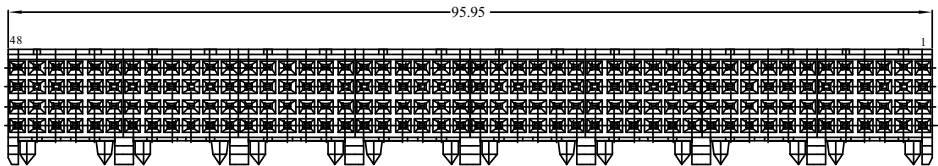

PCB pattern P6, see chapter PCB layouts

PARTNUMBERS

8575x - 1y01LF

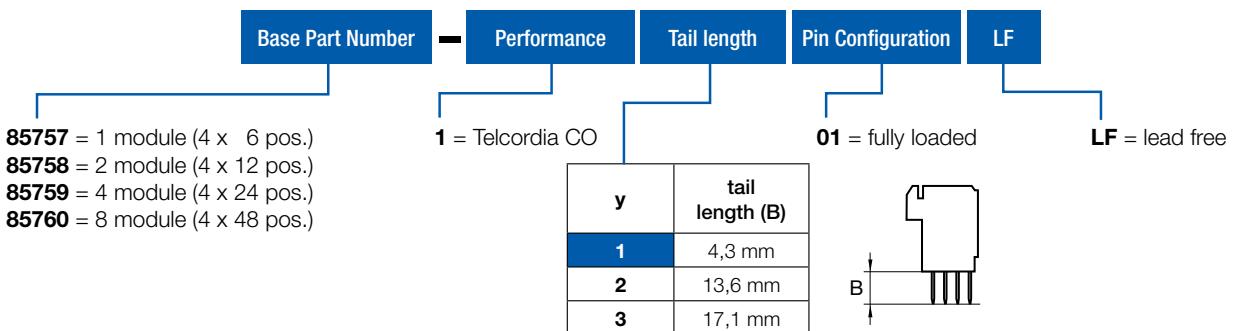

Note: blue marked in **tail length** is the preferred recommended standard
for other special patterns or loadings, please check drawings, all other configurations on request only

Header, 5 row, signal, right angle, solder to board, wide body

FEATURES

- In accordance with IEC 60917 and IEC 61076-4-104 (Futurebus+)
- 5 row and 2 mm pitch permit high signal density (250 contacts per 100mm connector length)
- Modular design guarantees flexibility

TECHNICAL DATA

PHYSICAL

- spacing: 2,00 mm x 2,00 mm
- housing: glass-filled LCP, colour natural
- flammability rating: UL 94 V-0
- pin material: phosphor bronze
- performance level: Telcordia CO

ELECTRICAL

- current rating: 1 A
- insulation resistance: 5x10³ MΩ initially, 1x10³ MΩ after tests
- withstanding voltage: 1000 V rms (sea level)

MECHANICAL PERFORMANCE

- insertion force: 0,45 N max. per individual signal contact (mating)
- withdrawal force: 0,15 N max. per individual signal contact (unmating)
- recommended hole diameter: 0,65-0,80 mm

ENVIRONMENTAL

- Operating temperature range: -55°C to +125°C
- RoHs information, this product is compatible according to the European Union Directive 2002/95/IEC

PACKAGING

- standard: trays

PROCESSING INFORMATION

- applicable soldering process: wave, IR, vapor phase

REFERENCE DATA

- Product specification: GS-12-446

APPLICATION EQUIPMENT

- for application equipment, check out the application equipment table on page 217-223



MATING DATA

■ Receptacle, straight, press-fit, page 79

- 1 mod – part number 85761-1101LF
- 2 mod – on request only
- 4 mod – part number 85763-1101LF
- 8 mod – on request only

■ Receptacle, straight, solder-to-board, page 77

- 1 mod – part numbers HM1S51FRR000H6PLF
- 2 mod – part numbers HM1S52FRR000H6PLF
- 4 mod – part numbers HM1S53FRR000H6PLF
- 8 mod – part numbers HM1S54FRR000H6PLF

TYPICAL APPLICATIONS

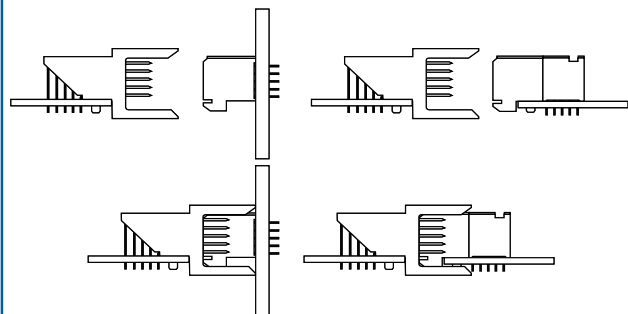

Header, 5 row, signal, right angle, solder to board, wide body

PRODUCT

1 Module

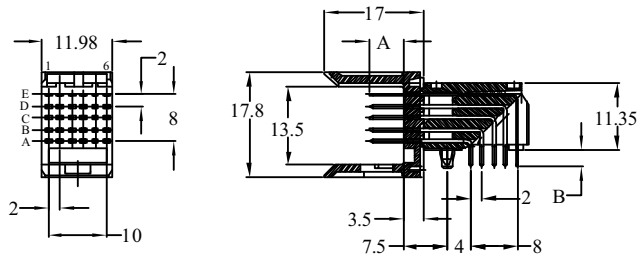

2 Module

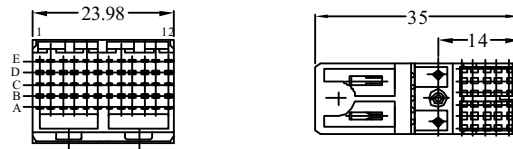

4 Module

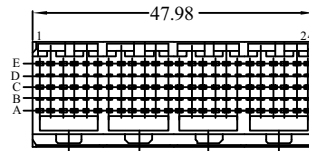

8 Module

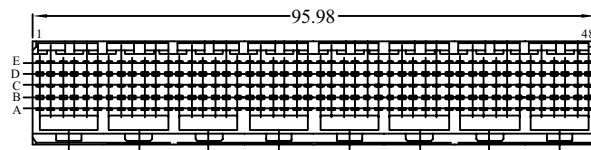

PCB pattern P2, see chapter PCB layouts

PARTNUMBERS

HM1L5 x LAP000H6PLF

Base Part Number	Type	no. of rows	no. of pos.	Configuration	000	Performance	Packaging	LF						
HM1	L = Signal header right angle, wide body	5 = 5 row		LAP = solder to board		H6 = Telcordia CO		LF = lead free						
				<table border="1"> <thead> <tr> <th> mating length (A) </th> <th> tail length (B) </th> </tr> </thead> <tbody> <tr> <td>5,75 mm</td> <td>2,90 mm</td> </tr> <tr> <td colspan="2">1,6 mm PCB thickness</td> </tr> </tbody> </table>	mating length (A)	tail length (B)	5,75 mm	2,90 mm	1,6 mm PCB thickness					
mating length (A)	tail length (B)													
5,75 mm	2,90 mm													
1,6 mm PCB thickness														
							P = trays							

1 = 1 module (5 x 6 pos.)
2 = 2 module (5 x 12 pos.)
3 = 4 module (5 x 24 pos.)
4 = 8 module (5 x 48 pos.)

Note: for other special patterns or loadings, please check drawings, all other configurations on request only

Header, 5 row, signal, right angle, press fit, wide body

FEATURES

- In accordance with IEC 60917 and IEC 61076-4-104 (Futurebus+)
- 5 row and 2 mm pitch permit high signal density (250 contacts per 100mm connector length)
- Modular design guarantees flexibility
- Eye of the needle press-fit contact

TECHNICAL DATA

PHYSICAL

- spacing: 2,00 mm x 2,00 mm
- housing: glass-filled LCP, colour natural
- flammability rating: UL 94 V-0
- pin material: phosphor bronze
- performance level: Telcordia CO

ELECTRICAL

- current rating: 1 A
- insulation resistance: $5 \times 10^3 \text{ M}\Omega$ initially, $1 \times 10^3 \text{ M}\Omega$ after tests
- withstanding voltage: 1000 V rms (sea level)

MECHANICAL PERFORMANCE

- insertion force: 0,45 N max. per individual signal contact (mating)
- withdrawal force: 0,15 N max. per individual signal contact (unmating)
- press-fit contact insertion: 55 N max. per pin
- press-fit pin withdrawal: 15 N min. per pin
- recommended hole diameter: 0,65-0,80 mm

ENVIRONMENTAL

- Operating temperature range: -55°C to +125°C
- RoHs information, this product is compatible according to the European Union Directive 2002/95/IEC

PACKAGING

- standard: trays

PROCESSING INFORMATION

- press fit

REFERENCE DATA

- Product specification: GS-12-445

APPLICATION EQUIPMENT

- for application equipment, check out the application equipment table on page 217-223

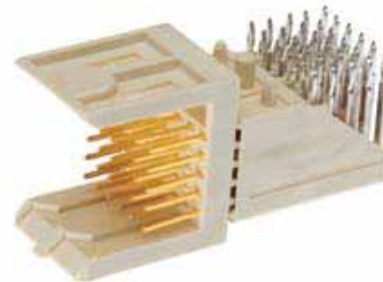

MATING DATA

Receptacle, straight, press-fit, page 79

- 1 mod – part number 85761-1101LF
- 2 mod – on request only
- 4 mod – part number 85763-1101LF
- 8 mod – on request only

Receptacle, straight, solder-to-board, page 77

- 1 mod – part numbers HM1S51FRR000H6PLF
- 2 mod – part numbers HM1S52FRR000H6PLF
- 4 mod – part numbers HM1S53FRR000H6PLF
- 8 mod – part numbers HM1S54FRR000H6PLF

TYPICAL APPLICATIONS

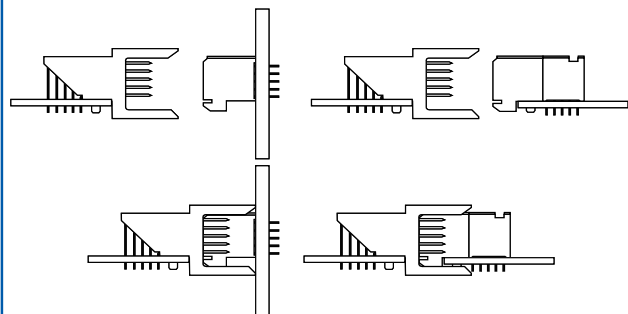

Header, 5 row, signal, right angle, press fit, wide body

PRODUCT

1 Module

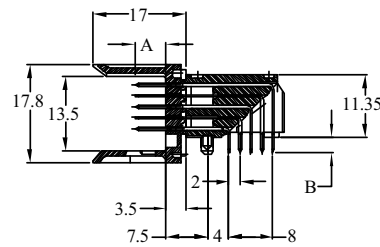
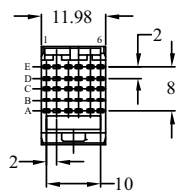

2 Module

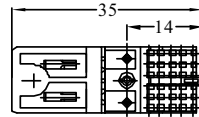
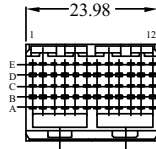

4 Module

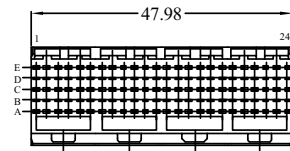

8 Module

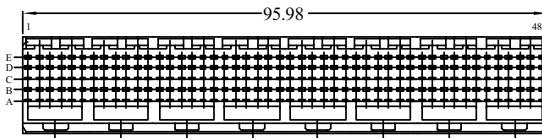

PCB pattern P2, see chapter PCB layouts

PARTNUMBERS

HM1L5 x LDP000H6PLF

Base Part Number	Type	no. of rows	no. of pos.	Configuration	000	Performance	Packaging	LF						
HM1	L = Signal header right angle, wide body	5 = 5 row		LDP = press fit		H6 = Telcordia CO		LF = lead free						
				<table border="1"> <thead> <tr> <th>mating length (A)</th> <th>tail length (B)</th> </tr> </thead> <tbody> <tr> <td>5,75 mm</td> <td>2,90 mm</td> </tr> <tr> <td colspan="2">1,6 mm PCB thickness</td> </tr> </tbody> </table>	mating length (A)	tail length (B)	5,75 mm	2,90 mm	1,6 mm PCB thickness					
mating length (A)	tail length (B)													
5,75 mm	2,90 mm													
1,6 mm PCB thickness														
							P = trays							

Note: for other special patterns or loadings, please check drawings, all other configurations on request only

Header, 5 row, signal, right angle, pin-in-paste, wide body

FEATURES

- In accordance with IEC 60917 and IEC 61076-4-104 (Futurebus+)
- 5 row and 2 mm pitch permit high signal density (250 contacts per 100mm connector length)
- Modular design guarantees flexibility

TECHNICAL DATA

PHYSICAL

- spacing: 2,00 mm x 2,00 mm
- housing: glass-filled LCP, colour natural
- flammability rating: UL 94 V-0
- pin material: phosphor bronze
- performance level: Telcordia CO

ELECTRICAL

- current rating: 1 A
- insulation resistance: $5 \times 10^3 \text{ M}\Omega$ initially, $1 \times 10^3 \text{ M}\Omega$ after tests
- withstanding voltage: 1000 V rms (sea level)

MECHANICAL PERFORMANCE

- insertion force: 0,45 N max. per individual signal contact (mating)
- withdrawal force: 0,15 N max. per individual signal contact (unmating)
- recommended hole diameter: 0,65-0,80 mm

ENVIRONMENTAL

- Operating temperature range: -55°C to $+125^\circ\text{C}$
- RoHs information, this product is compatible according to the European Union Directive 2002/95/IEC

PACKAGING

- standard: trays

PROCESSING INFORMATION

- Pick&place by vacuum nozzle or mechanical gripper
- automatic Surface-mount reflow process, resistance for Lead Free reflow temperature

REFERENCE DATA

- Product specification: GS-12-446

APPLICATION EQUIPMENT

- for application equipment, check out the application equipment table on page 217-223



MATING DATA

Receptacle, straight, press-fit, page 79

- 1 mod – part number 85761-1101LF

Receptacle, straight, solder-to-board, page 77

- 1 mod – part numbers HM1S51FRR000H6PLF

TYPICAL APPLICATIONS

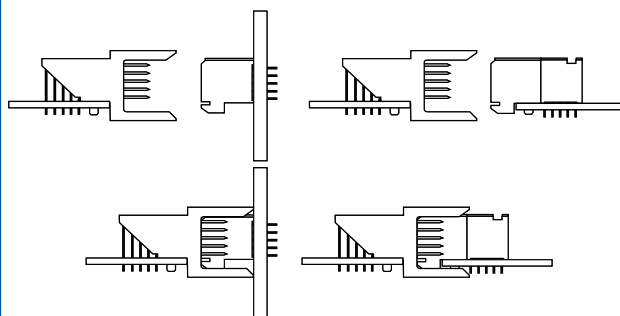

Header, 5 row, signal, right angle, pin-in-paste, wide body

PRODUCT

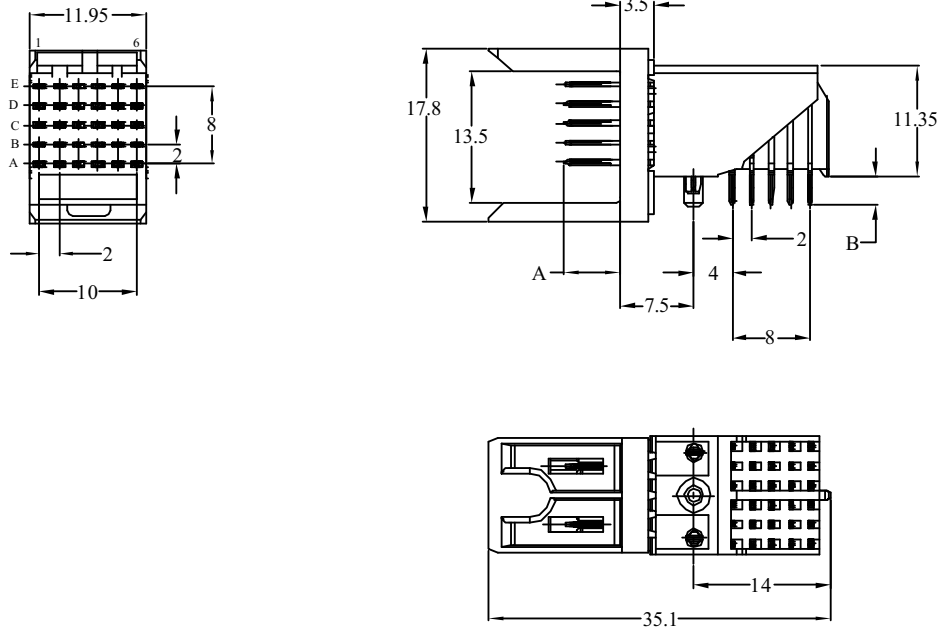

PCB pattern P2, see chapter PCB layouts

PARTNUMBERS

HM1L5 x LFP000H6PLF

Base Part Number	Type	no. of rows	no. of pos.	Configuration	000	Performance	Packaging	LF							
HM1	L = Signal header right angle, wide body	5 = 5 row	1 = 1 module (5 x 6 pos.)	LFP = Pin-in-Paste		H6 = Telcordia CO	P = trays	LF = lead free							
				<table border="1"> <thead> <tr> <th>mating length (A)</th> <th>tail length (B)</th> </tr> </thead> <tbody> <tr> <td>5,75 mm</td> <td>2,90 mm</td> </tr> <tr> <td colspan="2">1,6 mm PCB thickness</td> </tr> </tbody> </table>	mating length (A)	tail length (B)	5,75 mm	2,90 mm	1,6 mm PCB thickness						
mating length (A)	tail length (B)														
5,75 mm	2,90 mm														
1,6 mm PCB thickness															

Note: for other special patterns or loadings, please check drawings, all other configurations on request only

Receptacle, 5 row, signal, straight, solder to board

FEATURES

- In accordance with IEC 60917 and IEC 61076-4-104 (Futurebus+)
- 5 row and 2 mm pitch permit high signal density (250 contacts per 100mm connector length)
- Modular design guarantees flexibility
- Parallel board applications
- Tuning fork contact



TECHNICAL DATA

PHYSICAL

- spacing: 2,00 mm x 2,00 mm
- housing: glass-filled LCP, colour natural
- flammability rating: UL 94 V-0
- contact material: phosphor bronze
- performance level: Telcordia CO

ELECTRICAL

- current rating: 1 A
- insulation resistance: 5x10³ MΩ initially, 1x10³ MΩ after tests
- withstanding voltage: 1000 V rms (sea level)

MECHANICAL PERFORMANCE

- insertion force: 0,45 N max. per individual signal contact (mating)
- withdrawal force: 0,15 N max. per individual signal contact (unmating)
- recommended hole diameter: 0,65-0,80 mm

ENVIRONMENTAL

- Operating temperature range: -55°C to +125°C
- RoHs information, this product is compatible according to the European Union Directive 2002/95/IEC

PACKAGING

- standard: trays

PROCESSING INFORMATION

- Applicable process: wave, IR, vapor phase

REFERENCE DATA

- Product specification: GS-12-448

APPLICATION EQUIPMENT

- for application equipment, check out the application equipment table on page 217-223

MATING DATA

Header, right angle, press-fit, page 73

- 1 module-part number HM1L51LDP000H6PLF
- 2 module-part number HM1L52LDP000H6PLF
- 4 module-part number HM1L53LDP000H6PLF
- 8 module-part number HM1L54LDP000H6PLF

Header, right angle, solder-to-board, page 71

- 1 module-part number HM1L51LAP000H6PLF
- 2 module-part number HM1L52LAP000H6PLF
- 4 module-part number HM1L53LAP000H6PLF
- 8 module-part number HM1L54LAP000H6PLF

Header, right angle, Pin-in-Paste, page 75

- 1 module-part number HM1L51LFP000H6PLF

TYPICAL APPLICATIONS

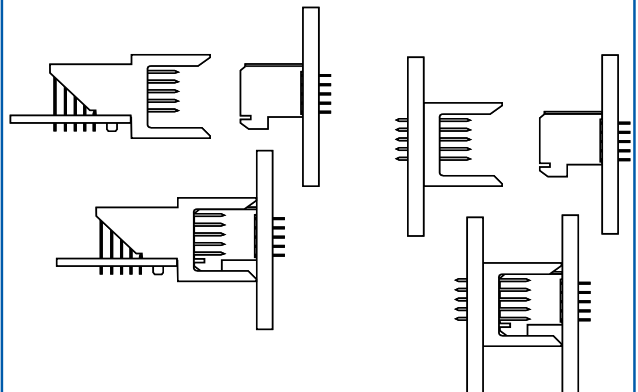

Receptacle, 5 row, signal, straight, solder to board

PRODUCT

1 Module

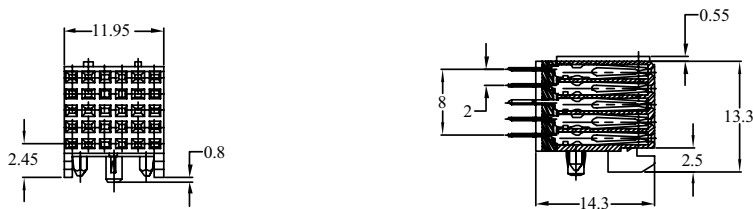

2 Module



4 Module

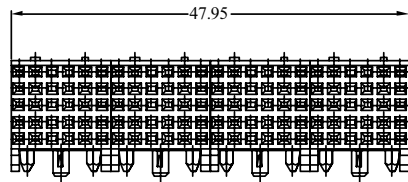

8 Module

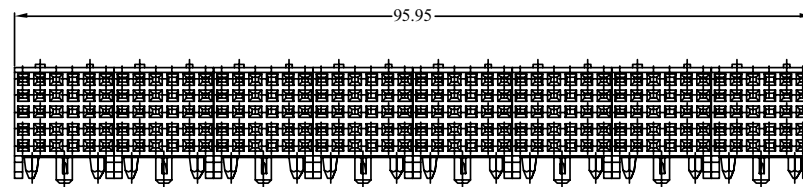

PCB pattern P7, see chapter PCB layouts

PARTNUMBERS

HM1S5 x FRR000H6PLF

Base Part Number	Type	no. of rows	no. of pos.	Configuration	000	Performance	Packaging	LF
HM1	S = signal receptacle straight	5 = 5 row		FRR = solder to board		H6 = Telcordia CO		LF = lead free
				tail length (B)				P = trays
				3,30 mm				

Note: for other special patterns or loadings, please check drawings, all other configurations on request only

Receptacle, 5 row, signal, straight, press fit

FEATURES

- In accordance with IEC 60917 and IEC 61076-4-104 (Futurebus+)
- 5 row and 2 mm pitch permit high signal density (250 contacts per 100mm connector length)
- Modular design guarantees flexibility
- Parallel board applications
- Tuning fork contact
- baby H-shape press-fit contact
- Flat rock design; can be pressed on PCB with flat press block



TECHNICAL DATA

PHYSICAL

- spacing: 2,00 mm x 2,00 mm
- housing: glass-filled LCP, colour natural
- flammability rating: UL 94 V-0
- contact material: phosphor bronze
- performance level: Telcordia CO

ELECTRICAL

- current rating: 1 A
- insulation resistance: 5×10^3 M Ω initially, 1×10^3 M Ω after tests
- withstanding voltage: 1000 V rms (sea level)

MECHANICAL PERFORMANCE

- insertion force: 0,45 N max. per individual signal contact (mating)
- withdrawal force: 0,15 N max. per individual signal contact (unmating)
- press-fit contact insertion: 100 N max. per pin
- press-fit pin withdrawal: 20 N min. per pin
- recommended hole diameter: 0,65-0,80 mm

ENVIRONMENTAL

- Operating temperature range: -55°C to +125°C
- RoHs information, this product is compatible according to the European Union Directive 2002/95/IEC

PACKAGING

- standard: tubes

PROCESSING INFORMATION

- press fit

REFERENCE DATA

- Product specification: GS-12-447

APPLICATION EQUIPMENT

- for application equipment, check out the application equipment table on page 217-223

MATING DATA

Header, right angle, press-fit, page 73

- 1 module-part number HM1L51LDP000H6PLF
- 2 module-part number HM1L52LDP000H6PLF
- 4 module-part number HM1L53LDP000H6PLF
- 8 module-part number HM1L54LDP000H6PLF

Header, right angle, solder-to-board, page 71

- 1 module-part number HM1L51LAP000H6PLF
- 2 module-part number HM1L52LAP000H6PLF
- 4 module-part number HM1L53LAP000H6PLF
- 8 module-part number HM1L54LAP000H6PLF

Header, right angle, Pin-in-Paste, page 75

- 1 module-part number HM1L51LFP000H6PLF

TYPICAL APPLICATIONS

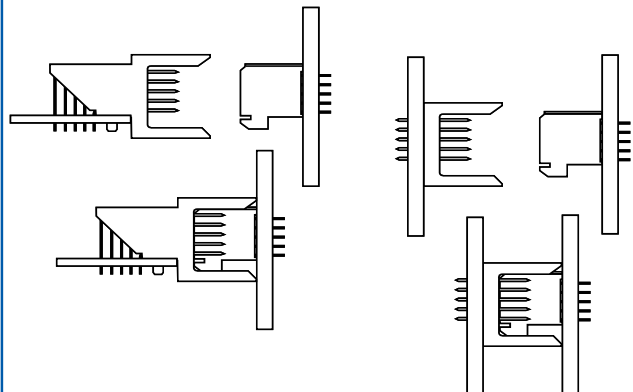

Receptacle, 5 row, signal, straight, press fit

PRODUCT

1 Module

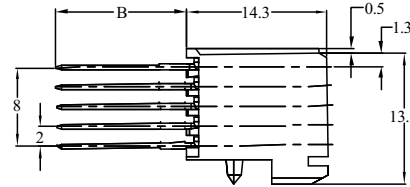
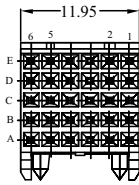

2 Module

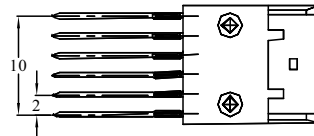
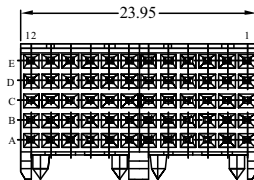

4 Module

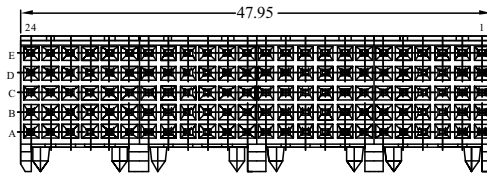

8 Module

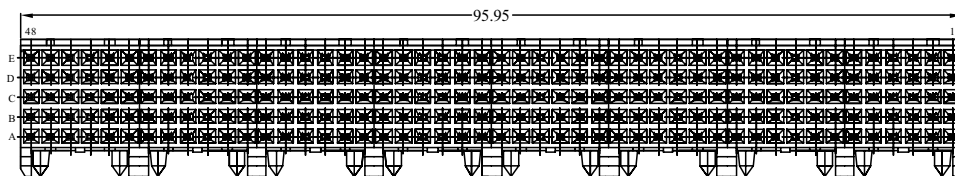

PCB pattern P7, see chapter PCB layouts

PARTNUMBERS

8576x - 1y01LF

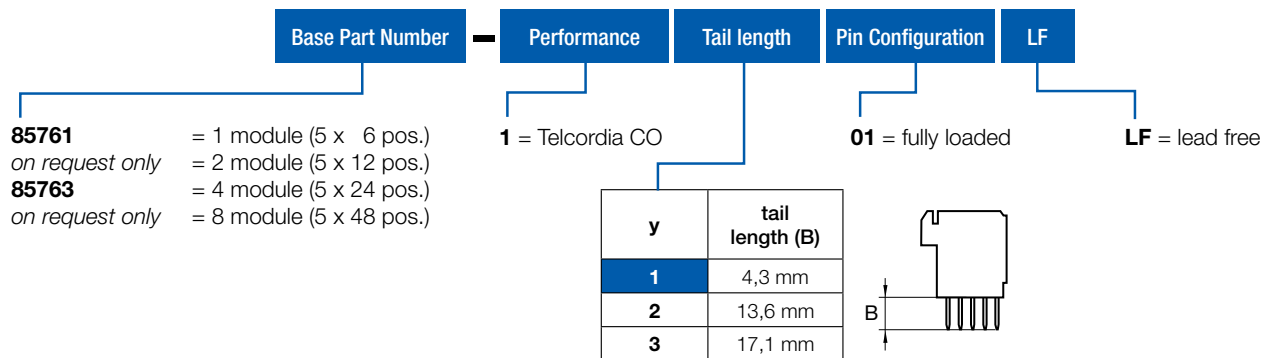



Note: blue marked in **tail length** is the preferred recommended standard
for other special patterns or loadings, please check drawings, all other configurations on request only





METRAL® SHROUDS

-  Shroud, 4 row, wide body
-  Shroud, 5 row, wide body
-  Shroud, 8 row, wide body

Shroud, 4 row, wide body

FEATURES

- In accordance with IEC 60917 and IEC 61076-4-104 (Futurebus+)
- Different stand-off versions for rear-plug-up
- Easy direct mounting of the shroud on the pins without need of mounting shroud to PCB.
- Retention force from the shroud on the press-connector is on the non-contact side of the pin.
- Wide lead-in for easy mating of female connectors
- Designed-in polarization.
- Optional coding.



TECHNICAL DATA

PHYSICAL

- housing: glass-filled LCP, colour natural
- flammability rating: UL 94 V-0

ELECTRICAL

- withstanding voltage: 1000 V rms (sea level)

MECHANICAL PERFORMANCE

- insertion force: 0,45 N max. per individual signal contact (mating)
- withdrawal force: 0,15 N max. per individual signal contact (unmating)

ENVIRONMENTAL

- Operating temperature range: -55°C to +105°C
- RoHs information, this product is compatible according to the European Union Directive 2002/95/IEC

PROCESSING INFORMATION

- used over pins previously staked into the pc board

REFERENCE DATA

- product specification: GS-12-180

APPLICATION EQUIPMENT

- for application equipment, check out the application equipment table on page 217-223.

MATING DATA

- 4 row Header, straight, press-fit, page 27

- 1 mod 70232-116LF
- 2 mod 70233-116LF
- 4 mod 70234-116LF
- 8 mod 70235-116LF

TYPICAL APPLICATIONS

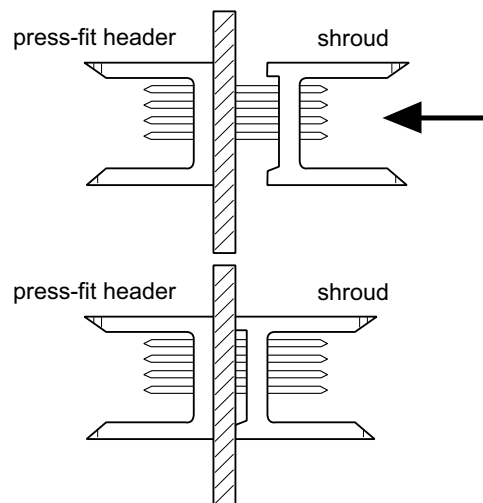

Shroud, 4 row, wide body

PRODUCT

1 Module
70203-111LF

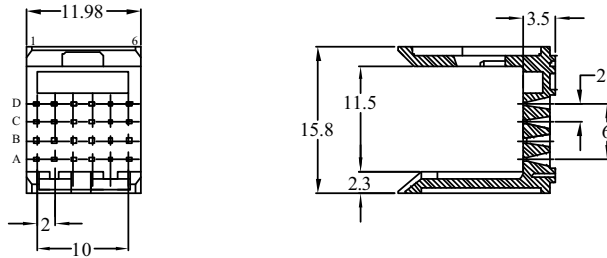

2 Module
70203-112LF

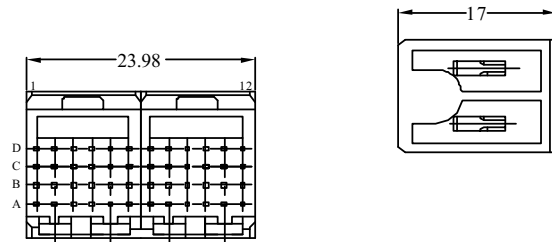

4 Module
70203-113LF

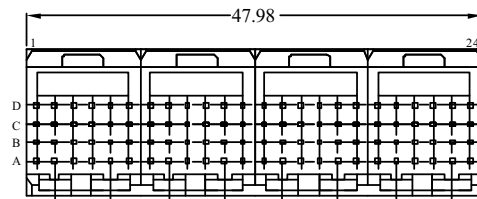

8 Module
70203-114LF

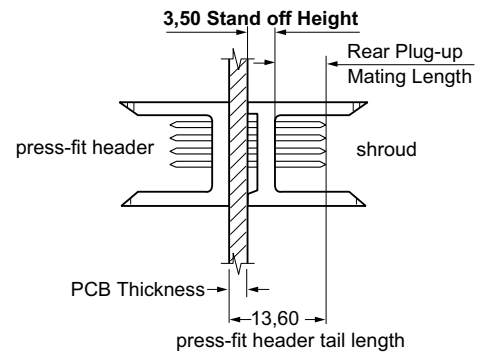
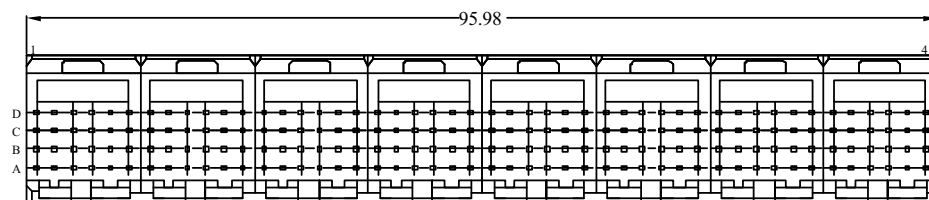

PARTNUMBERS

70203 - yyyLF

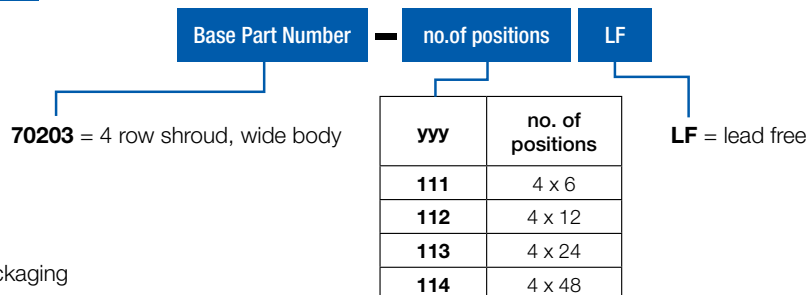

Note: Box packaging

Shroud, 5 row, wide body

FEATURES

- In accordance with IEC 60917 and IEC 61076-4-104 (Futurebus+)
- Different stand-off versions for rear-plug-up
- Easy direct mounting of the shroud on the pins without need of mounting shroud to PCB.
- Retention force from the shroud on the press-connector is on the non-contact side of the pin.
- Wide lead-in for easy mating of female connectors
- Designed-in polarization.
- Optional coding.



TECHNICAL DATA

PHYSICAL

- housing: glass-filled LCP, colour natural
- flammability rating: UL 94 V-0

ELECTRICAL

- withstanding voltage: 1000 V rms (sea level)

MECHANICAL PERFORMANCE

- insertion force: 0,45 N max. per individual signal contact (mating)
- withdrawal force: 0,15 N max. per individual signal contact (unmating)

ENVIRONMENTAL

- Operating temperature range: -55°C to +105°C
- RoHs information, this product is compatible according to the European Union Directive 2002/95/IEC

PROCESSING INFORMATION

- used over pins previously staked into the pc board

REFERENCE DATA

- product specification: GS-12-180

APPLICATION EQUIPMENT

- for application equipment, check out the application equipment table on page 217-223

MATING DATA

- 4 row Header, straight, press-fit, page 41

- 1 mod 89006-116LF
- 2 mod 89007-116LF
- 4 mod 89008-116LF
- 8 mod 89009-116LF

TYPICAL APPLICATIONS

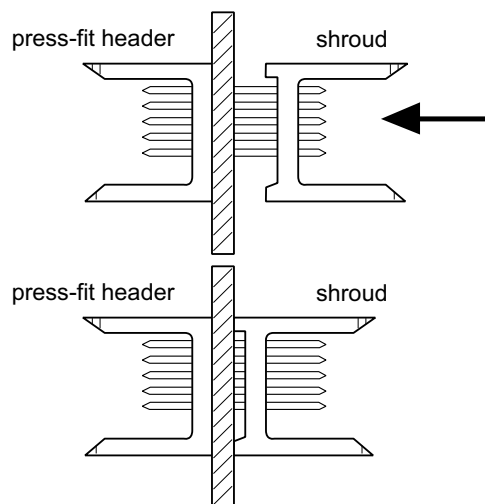

Shroud, 5 row, wide body

PRODUCT

1 Module
89055-111LF

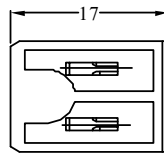
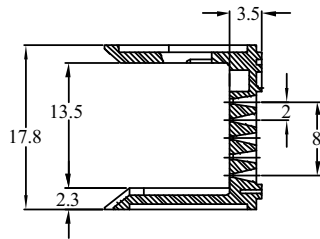
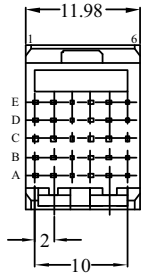

2 Module
89055-112LF

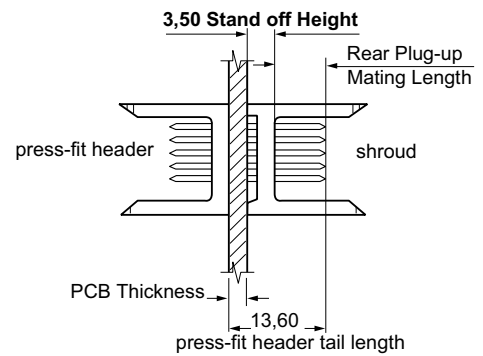
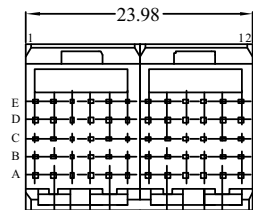

4 Module
89055-113LF

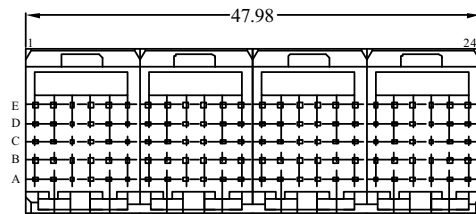

8 Module
89055-114LF

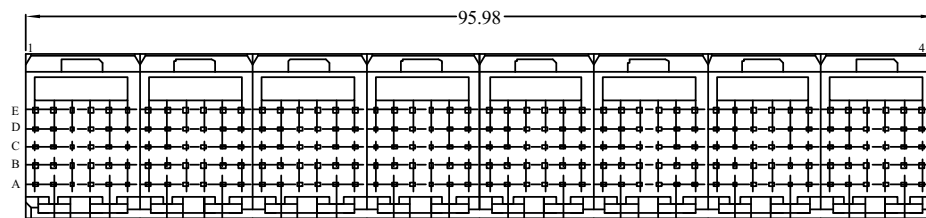

PARTNUMBERS

89055 - yyyLF

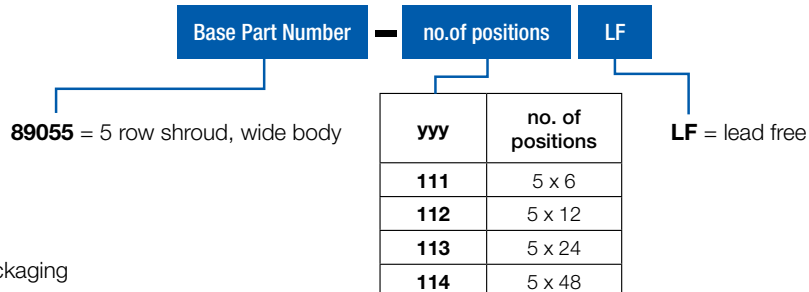

Note: Box packaging

Shroud, 8 row, wide body

FEATURES

- In accordance with IEC 60917 and IEC 61076-4-104 (Futurebus+)
- 8 row and 2 mm pitch permit high signal density (800 contacts per 100mm connector length)
- Stackable with other METRAL® function modules (power, I/O)
- 2 modules shroud, 8 rows by 6 position

TECHNICAL DATA

PHYSICAL

- spacing: 2,00 mm x 2,00 mm
- housing: glass-filled LCP, colour natural
- flammability rating: UL 94 V-0
- pin material: phosphor bronze
- performance level: Telcordia CO

ELECTRICAL

- current rating: 1 A
- insulation resistance: $5 \times 10^3 \text{ M}\Omega$ initially, $1 \times 10^3 \text{ M}\Omega$ after tests
- withstanding voltage: 1000 V rms (sea level)

MECHANICAL PERFORMANCE

- insertion force: 0,45 N max. per individual signal contact (mating)
- withdrawal force: 0,15 N max. per individual signal contact (unmating)

ENVIRONMENTAL

- Operating temperature range: -55°C to +125°C
- RoHs information, this product is compatible according to the European Union Directive 2002/95/IEC

PACKAGING

- standard: tubes

PROCESSING INFORMATION

- used over pins previously staked into the pc board

REFERENCE DATA

- Product specification: GS-12-134

APPLICATION EQUIPMENT

- for application equipment, check out the application equipment table on page 217-223



MATING DATA

- Header, straight, press-fit, page 49

- part number 74771-102011LF (used opposite board side)

- Receptacle, straight, press-fit, page 51

- part number 74770-102LF

TYPICAL APPLICATIONS

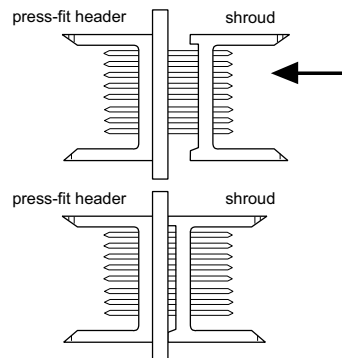

Shroud, 8 row, wide body

PRODUCT

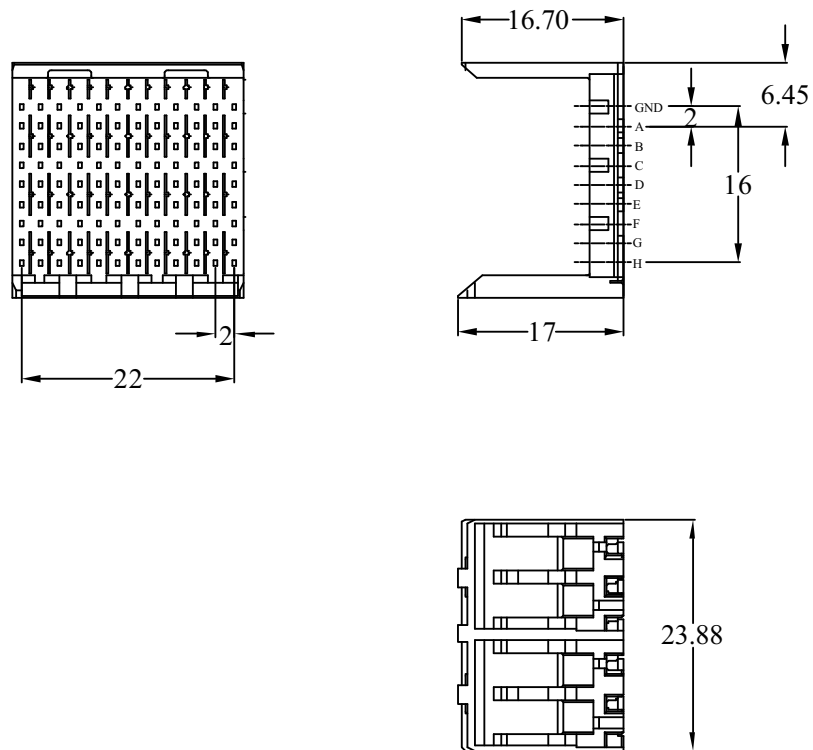

PARTNUMBERS

98173 - 102LF

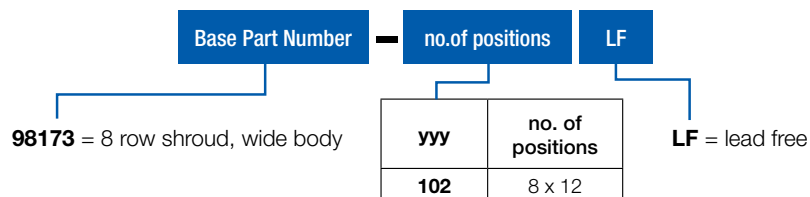



Note: Box packaging

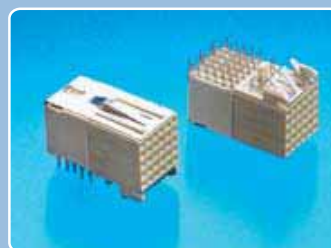



ELECTRICAL ENHANCED

METRAL® ELECTRICAL ENHANCED SIGNAL CONNECTORS

-  Header, Straight, 5 row
-  Shroud, 5 row
-  Receptacle, Right Angle, 5 row

Header, 5+2 row, signal, straight, press-fit, wide body

FEATURES

- ▶ 5 row Header
- ▶ 2 row Shielding, because of die-cast housing all signal pins are surrounded by a ground path, consequently reducing crosstalk and ground bounce.
- ▶ EMI of 15 dB
- ▶ Press-fit, eye of the needle contact

TECHNICAL DATA

PHYSICAL

- ▶ Housing: Die-cast zinc alloy
- ▶ Wafer material: glass filled LCP, UL 94 V-0, color natural
- ▶ Contact material: Phosphor bronze
- ▶ Performance level: Telcordia CO

ELECTRICAL

- ▶ current rating: 1 A
- ▶ withstanding voltage: 1000 V rms (sea level)

MECHANICAL PERFORMANCE

- ▶ insertion force: 0,45 N max. per individual signal contact (mating)
- ▶ withdrawal force: 0,15 N max. per individual signal contact (unmating)
- ▶ press-fit contact insertion: 65 N max. per pin
- ▶ press-fit pin withdrawal: 20 N min. per pin
- ▶ recommended hole diameter: 0,65-0,80 mm

ENVIRONMENTAL

- ▶ Operating temperature range: -55°C to +125°C
- ▶ RoHs information, this product is compatible according to the European Union Directive 2002/95/IEC

PACKAGING

- ▶ standard: tubes

PROCESSING INFORMATION

- ▶ press fit

REFERENCE DATA

- ▶ Product specification GS-12-074
- ▶ Application specification TA-941

APPLICATION EQUIPMENT

- ▶ for application equipment, check out the application equipment table on page 217-223



MATING DATA

Electrical Enhanced Receptacle, Signal, right angle

- ▶ part number 85847-102LF, page 139

Electrical Enhanced Shroud, wide body

- ▶ part numbers 70438-111LF, page 137

TYPICAL APPLICATIONS

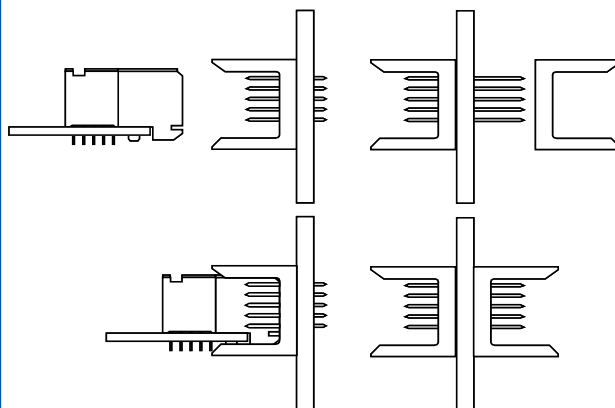

Header, 5+2 row, signal, straight, press-fit, wide body

PRODUCT

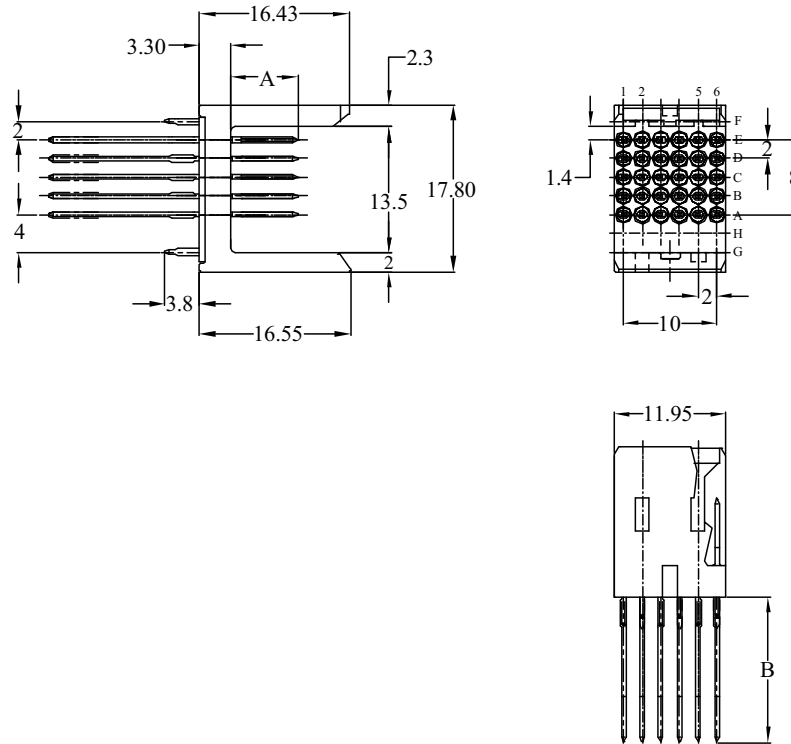

PCB pattern P15, see chapter PCB layouts

ELECTRICAL ENHANCED

PARTNUMBERS

70437 - 1yyLF

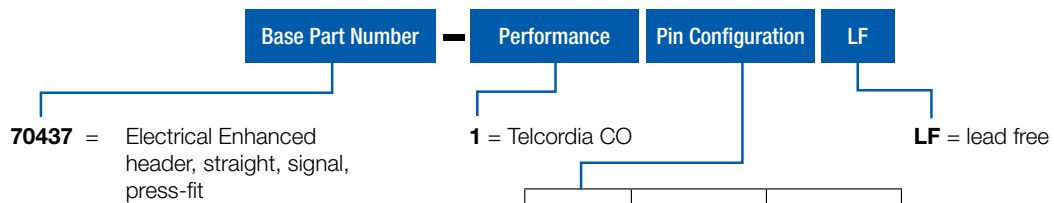

yy	mating length (A)	rear plug up length (B)
11	6,50 mm	4,30 mm
16	5,75 mm	4,30 mm
18	5,00 mm	4,30 mm
21	6,50 mm	13,60 mm
26	5,75 mm	13,60 mm
28	5,00 mm	13,60 mm

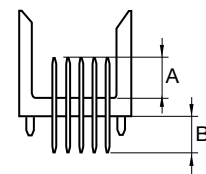

Note: for other special patterns or loadings, please check drawings, all other configurations on request only

Shroud, 5+2 row, wide body

FEATURES

- 5 row Shroud
- 2 row Shielding, because of die-cast housing all signal pins are surrounded by a ground path, consequently reducing crosstalk and ground bounce.
- EMI of 15 dB

TECHNICAL DATA

PHYSICAL

- Housing: Die-cast zinc alloy
- Wafer material: glass filled LCP, UL 94 V-0, color natural

ELECTRICAL

- current rating: 1 A
- withstanding voltage: 1000 V rms (sea level)

MECHANICAL PERFORMANCE

- insertion force: 0,45 N max. per individual signal contact (mating)
- withdrawal force: 0,15 N max. per individual signal contact (unmating)

ENVIRONMENTAL

- Operating temperature range: -55°C to +125°C
- RoHs information, this product is compatible according to the European Union Directive 2002/95/IEC

PACKAGING

- standard: tubes

PROCESSING INFORMATION

- press fit

REFERENCE DATA

- Product specification GS-12-074

APPLICATION EQUIPMENT

- for application equipment, check out the application equipment table on page 217-223



MATING DATA

- Rear plug up- Header, Signal, straight, press-fit, page 135
- partnumber 70437-121LF
- partnumber 70437-126LF
- partnumber 70437-128LF

TYPICAL APPLICATIONS

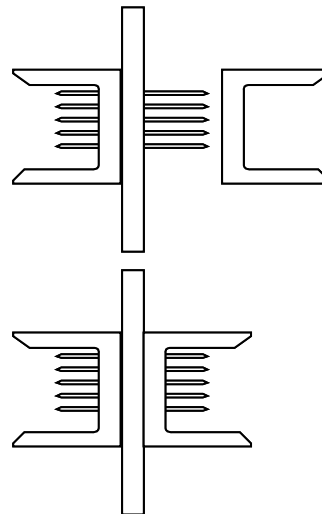

Shroud, 5+2 row, wide body

PRODUCT

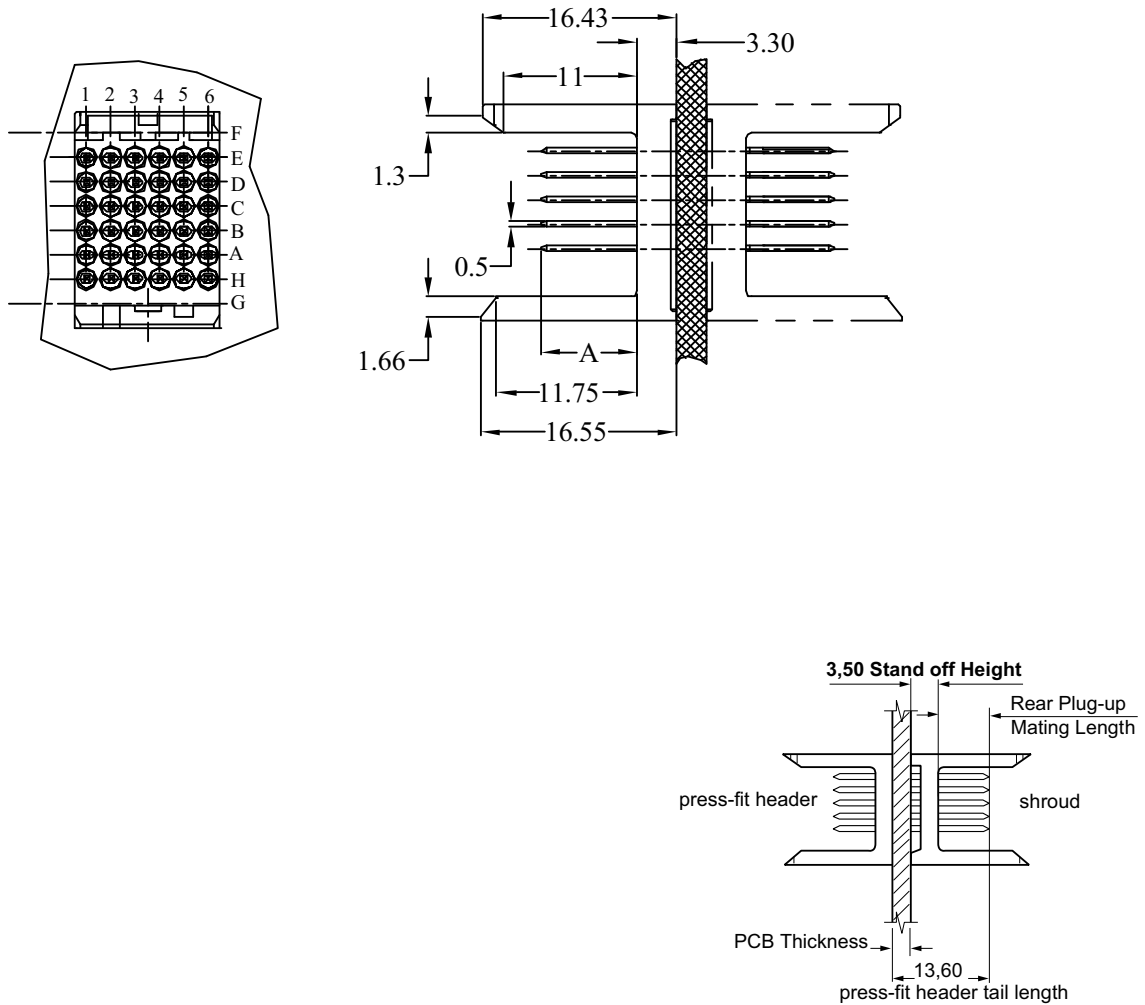

ELECTRICAL ENHANCED

PARTNUMBERS

70438 - 111LF

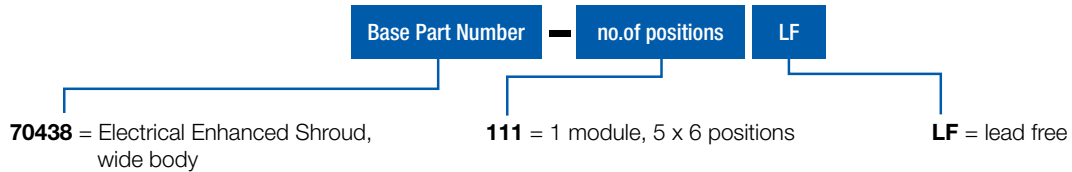

Receptacle, 5+2 row, signal, right angle, press fit

FEATURES

- 5 row Receptacle
- 2 row Shielding, because of die-cast housing all signal pins are surrounded by a ground path, consequently reducing crosstalk and ground bounce.
- EMI of 15 dB
- Press-fit, eye of the needle contact

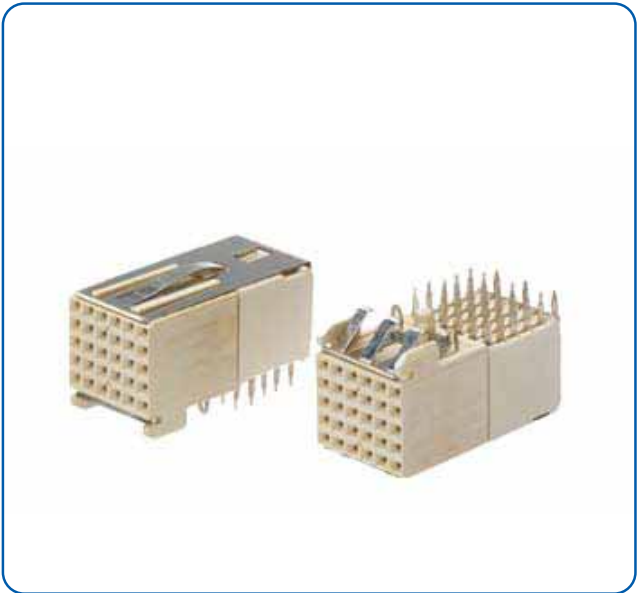

TECHNICAL DATA

PHYSICAL

- Housing: glass-filled LCP, colour natural
- flammability rating: UL 94 V-0
- Contact material: Phosphor bronze
- Shielding material: Phosphor bronze
- Performance level: Telcordia CO

ELECTRICAL

- current rating: 1 A
- withstanding voltage: 1000 V rms (sea level)

MECHANICAL PERFORMANCE

- insertion force: 0,45 N max. per individual signal contact (mating)
- withdrawal force: 0,15 N max. per individual signal contact (unmating)
- press-fit contact insertion: 65 N max. per pin
- press-fit pin withdrawal: 20 N min. per pin
- recommended hole diameter: 0,65-0,80 mm

ENVIRONMENTAL

- Operating temperature range: -55°C to +125°C
- RoHs information, this product is compatible according to the European Union Directive 2002/95/IEC

PACKAGING

- standard: tubes

PROCESSING INFORMATION

- press fit

REFERENCE DATA

- Product specification GS-12-074
- Application specification TA-941

APPLICATION EQUIPMENT

- for application equipment, check out the application equipment table on page 217-223

MATING DATA

■ Electrical Enhanced Header, Signal, straight, page 135

- part number 70437-111LF
- part number 70437-116LF
- part number 70437-118LF

TYPICAL APPLICATIONS

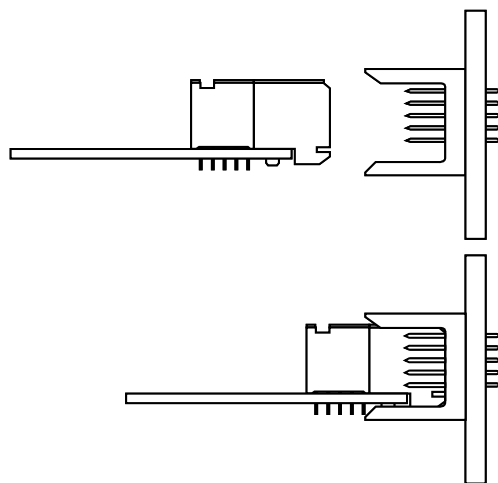

Receptacle, 5+2 row, signal, right angle, press fit

PRODUCT

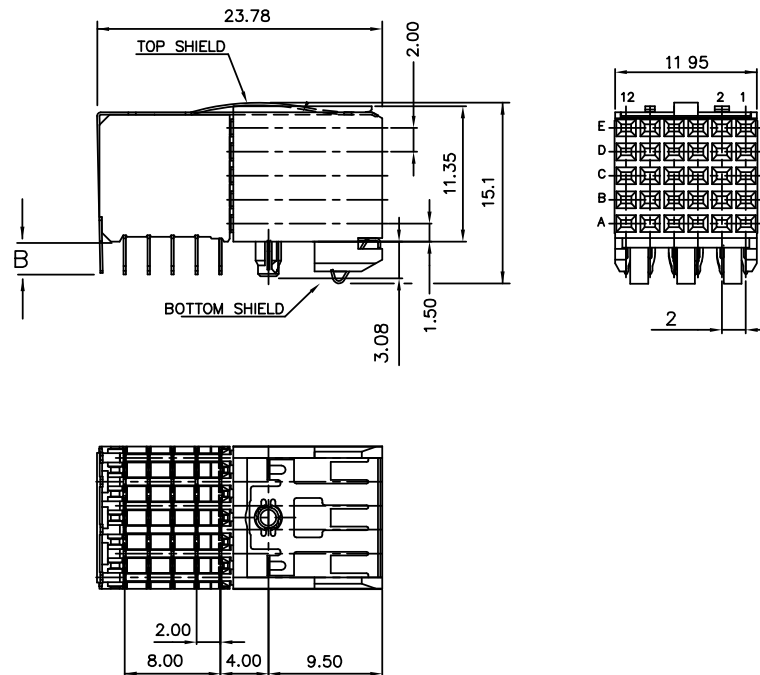

PCB pattern P2, see chapter PCB layouts

ELECTRICAL ENHANCED

PARTNUMBERS

85847 - 102LF

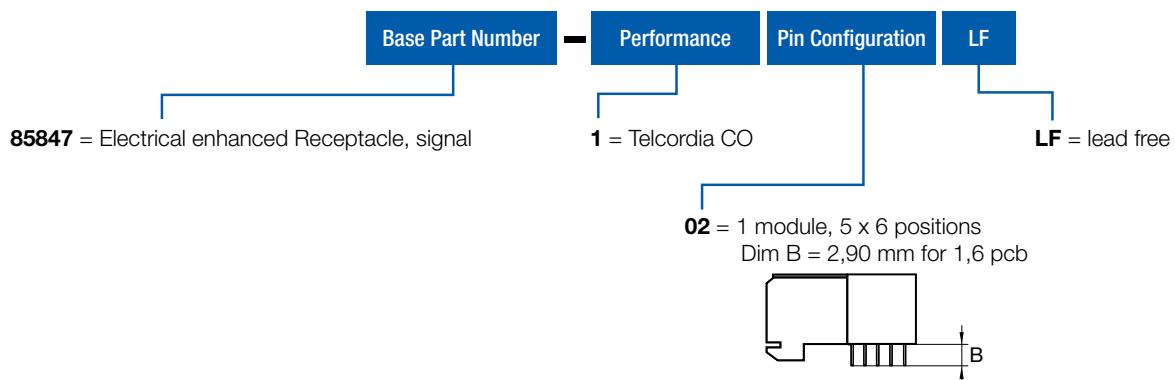







SHIELDED CONNECTORS

METRAL® SHIELDED SIGNAL CONNECTORS

-  Header, Straight, 5 row
-  Round cable connector

Shielded Header, 5 row, signal, straight, press-fit

FEATURES

- Because of die-cast housing all signal pins are surrounded by a ground path.
- EMI improved
- 5 row Header, 1 module
- active latching system
- Press-fit, eye of the needle contact

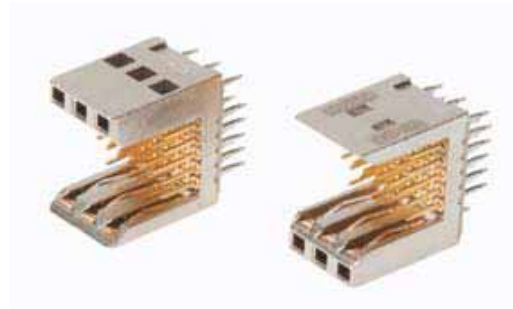

TECHNICAL DATA

PHYSICAL

- Housing: Die-cast zinc alloy
- Wafer material: glass filled LCP, UL 94 V-0, color natural
- Contact material: Phosphor bronze
- Ground spring material : copper-nickel-tin alloy
- Performance level: Telcordia CO

ELECTRICAL

- current rating: 1 A
- withstanding voltage: 1000 V rms (sea level)

MECHANICAL PERFORMANCE

- insertion force: 0,45 N max. per individual signal contact (mating)
- withdrawal force: 0,15 N max. per individual signal contact (unmating)
- press-fit contact insertion: 65 N max. per pin
- press-fit pin withdrawal: 20 N min. per pin
- recommended hole diameter: 0,65-0,80 mm

ENVIRONMENTAL

- Operating temperature range: -55°C to +125°C
- RoHs information, this product is compatible according to the European Union Directive 2002/95/IEC

PACKAGING

- standard: tubes

PROCESSING INFORMATION

- press fit

REFERENCE DATA

- Product specification GS-12-135

APPLICATION EQUIPMENT

- for application equipment, check out the application equipment table on page 217-223

MATING DATA

- Round Cable connector, Shielded
 - 5 x 6 pos. part number 85706-xxxxLF, page 145
- Cable Connector
 - 5 row, part number 72478-1111LF, page 175
- Receptacle, 5 row
 - Right angle, press-fit, part number 89047-102LF, page 45
 - Straight, press-fit, part number 85761-1101LF, page 79

TYPICAL APPLICATIONS

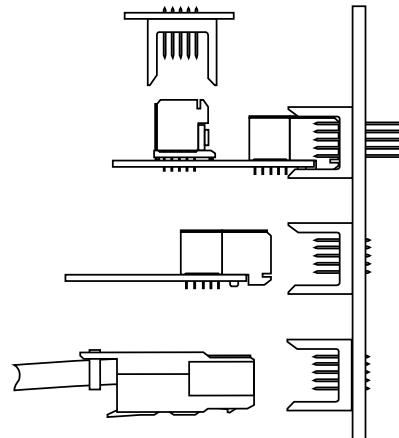

Header, 5 row, signal, straight, press-fit

PRODUCT

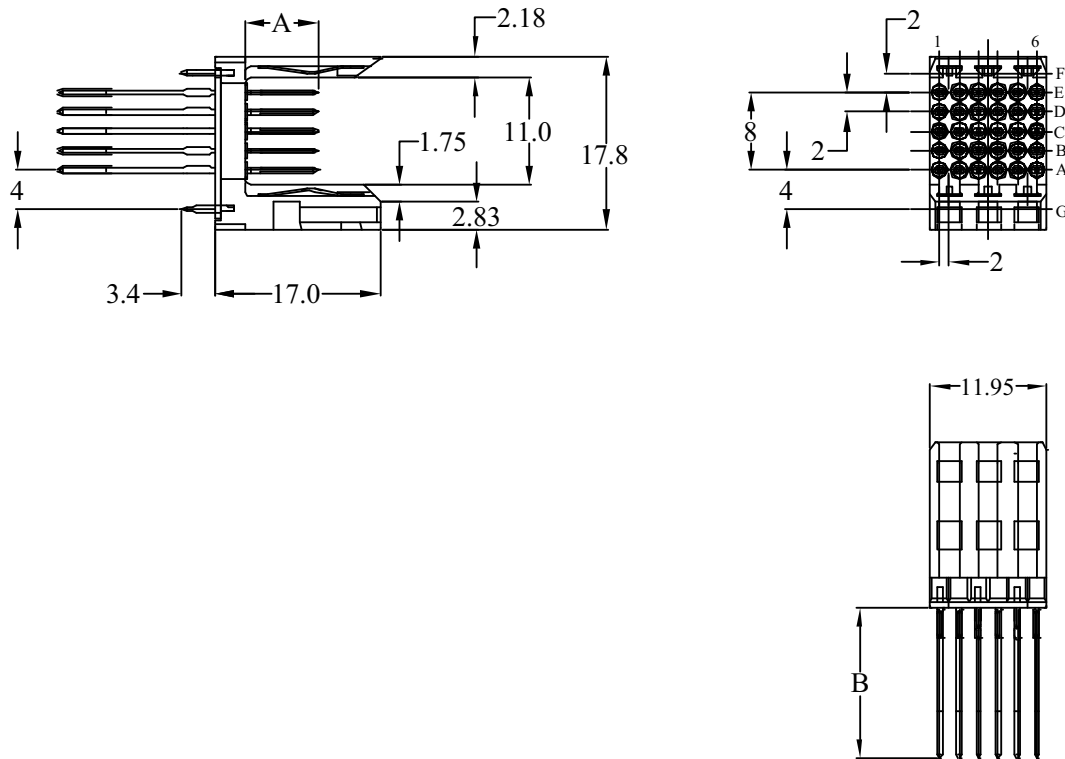

PCB pattern P15, see chapter PCB layouts

SHIELDED CONNECTORS

PARTNUMBERS

72031 - 1yyLF

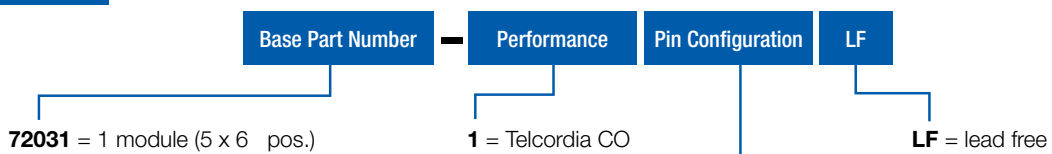

yy	mating length (A)	tail length (B)
11	6,50 mm	4,30 mm
16	5,75 mm	4,30 mm
first-make last-brake 14	row A = 5,75 mm	4,30 mm
	row B = 5,75 mm	4,30 mm
	row C = 7,25 mm	4,30 mm
	row D = 5,75 mm	4,30 mm
	row E = 5,75 mm	4,30 mm

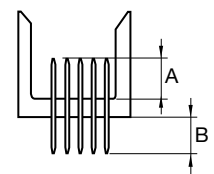

Note: for other special patterns or loadings, please check drawings, all other configurations on request only

Shielded Cable Connector, 5 row, signal

FEATURES

- 5 row , 1 module Round Cable Connector
- Heat Shrink or Crimp Ring version
- EMI improved
- Active latching system
- AWG size 24,26,28 and 30
- Reliable dual beam contact
- IDC wire termination

TECHNICAL DATA

PHYSICAL

- Housing: glass filled thermoplastic polyester, color grey
- Latch: polycarbonate, color black, UL 94 V-0
- Cover: copper-nickel-tin alloy
- Contact material: Phosphor bronze
- Performance level: Telcordia CO

ELECTRICAL

- current rating: 1 A
- withstanding voltage: 1000 V rms (sea level)

MECHANICAL PERFORMANCE

- insertion force: 0,645 N max. per individual signal contact (mating)
- withdrawal force: 0,36 N max. per individual signal contact (unmating)

ENVIRONMENTAL

- Operating temperature range: -55°C to +125°C
- RoHs information, this product is compatible according to the European Union Directive 2002/95/IEC

PACKAGING

- Kits, bags of 100 pcs

REFERENCE DATA

- application specification GES-20-003

APPLICATION EQUIPMENT

- for application equipment, check out the application equipment table on page 217-223



MATING DATA

- Shielded Header, straight, press-fit, wide body, page 143
 - part number 72031-116LF
- Header, straight, press-fit, wide body, page 41
 - part number 89006-116LF
- Header, right angle, press-fit, wide body, page 73
 - part number HM151LDP000H6PLF

TYPICAL APPLICATIONS

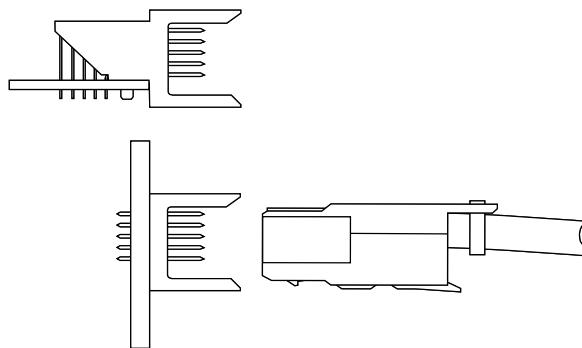

Shielded Cable Connector, 5 row, signal

PRODUCT

Heat shrink version

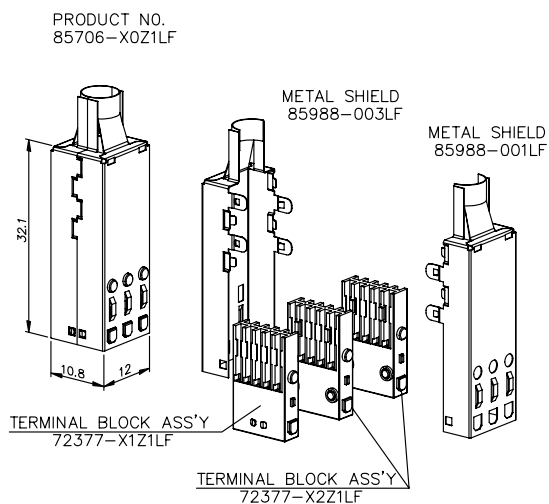

Crimped version

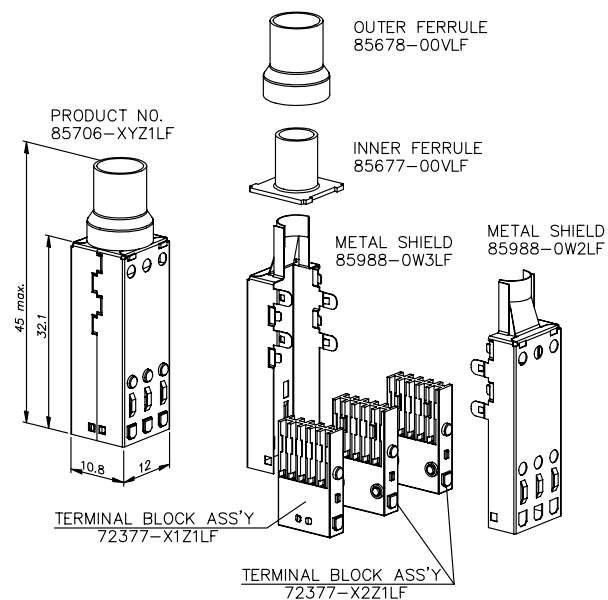

SHIELDED CONNECTORS

PARTNUMBERS

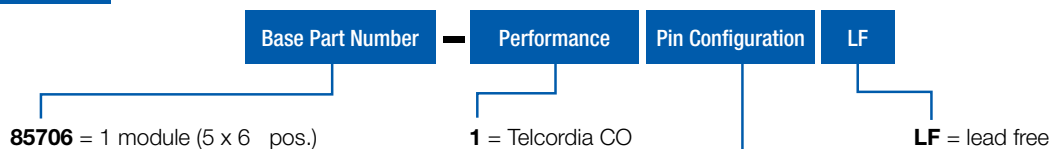

85706 - 1yz1LF



yz1	
y = 0	heat shrink version
y = 2	crimped version inner ferrule 8 mm dia. outer ferrule 10 mm dia.
z = 1	AWG size: 26 to 24 AWG
z = 2	AWG size: 30 to 28 AWG

For more information about e-catalog or FCI
sales offices, headquarters, agents and local distributors,
visit www.fci.com



Americas - Phone: 1 (800) 237 2374  Europe - Phone: 33 1 39 49 21 83  Asia/Pacific - Phone: 65 6549 6666

ELXMETRAL0108EA4E