

FEATURES

- Photo Mos Relay and Optocoupler in One Package
- Package - Single 8 Pin DIP
- I/O Isolation, 3750 V_{RMS}
- Surface Mount Option
- Optocoupler
 - Bi-directional Current Detection
- Mos Relay
 - Typical R_{ON} 20Ω
 - Load Voltage 350 V
 - Load Current 130 mA
 - High Surge Capability
 - Linear, AC/DC Operation
 - Clean Bounce Free Switching
 - Low Power Consumption
 - High Reliability Monolithic Receptor
- Applications
 - Telecommunications
 - Telecom Switching
 - Tip/Ring Circuits
 - Modem Switching (Laptop, Notebook, Pocket Size)
 - Hookswitch
 - Dial Pulsing
 - Ground Start
 - Ringer Injection
 - Loop Detect
 - Ring Detect

DESCRIPTION

The LH1529 Telecom switch consists of an optically coupled Photo Mos Relay and a bi-directional input opto-coupler. The Relay is ideal for performing switchhook and dial-pulse switching while the optocoupler performs ring detection and loop current sensing functions. Both the Relay and opto coupler provide 3750 V_{RMS} of input to output isolation.

The Relay uses high voltage DMOS technology. The Relay features low ON-resistance, high breakdown voltage that protects the relay from telephone line induced lightning surges.

The optocoupler provides bi-directional current sensing via two antiparallel GaAs infrared emitting diodes. The opto channel provides a minimum CTR of 30% at ±1 mA.

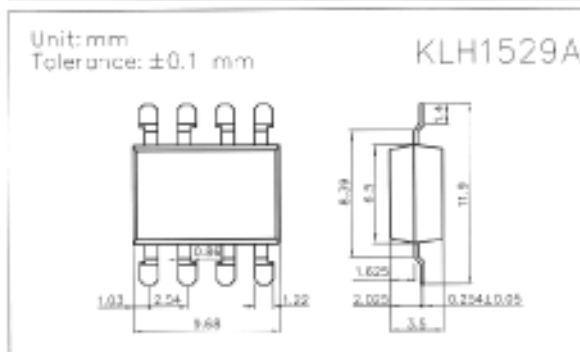
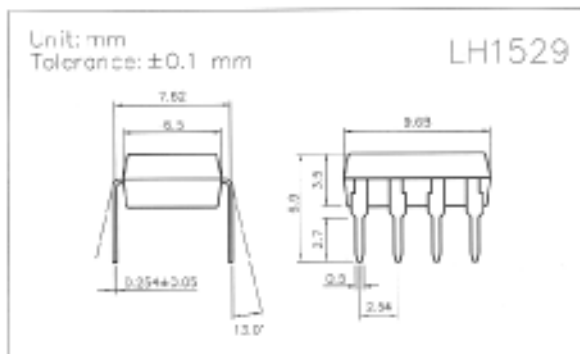

Absolute Maximum Ratings (T_A = 25°C)

Emitter (Input)

Reverse Voltage.....	5.0V
Continuous Forward Current.....	50mA
Peak Forward Current (1s).....	1A
Power Dissipation.....	100mW
Derate Linearly from 25°C.....	1.3mW/°C

Detector (Output)

Output Breakdown Voltage.....	±350V
Continuous Load Current.....	±130mA
Power Dissipation.....	500mW

General Characteristics

Isolation Test Voltage.....	3750VAC _{RMS}
Isolation Resistance	
V _{IO} = 500V, T _A = 25°C.....	≥10 ¹⁰ Ω
Total Power Dissipation.....	550mW
Derate Linearly from 25°C.....	2.5mW/°C
Storage Temperature Range.....	-40 to +150°C
Operating Temperature Range.....	-40 to +85°C
Junction Temperature.....	100°C
Soldering Temperature, 2mm from case, 10 sec... ..	260°C

● Turn on/Turn off time

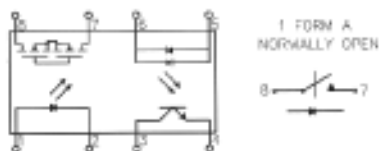

65 Shark River Road, Neptune, New Jersey 07753-7423

Tel: 732-922-6333 Fax: 732-922-6363 E-Mail: globalcomponents@msn.com

Characteristics

($T_A = 25^\circ\text{C}$)

Description	Symbol	Min.	Typ.	Max.	Unit	Test Condition
Emitter (Input)						
Forward Voltage	V_F		1.8	2.0	V	$I_F = 10\text{ mA}$
Operation Input Current	I_{FON}			5	mA	$V_L = \pm 20\text{ V}$, $I_L = 100\text{ mA}$, $t = 10\text{ ms}$
Recovery Input Current	I_{FOFF}	0.2			mA	$V_L = \pm 20\text{ V}$, $I_L < 5\text{ }\mu\text{A}$
Detector (output)						
Output Breakdown Voltage	V_B	350			V	$I_B = 50\text{ }\mu\text{A}$
Output Off-State Leakage	$I_{T(OFF)}$		0.2	1	μA	$V_T = 100\text{ V}$, $I_F = 0\text{ mA}$
I/O Capacitance	C_{ISO}		6		pF	$I_F = 0$, $f = 1\text{ MHz}$
ON Resistance	R_{ON}		20	30	Ω	$I_L = 100\text{ mV}$, $I_F = 10\text{ mA}$
Turn-on Time	T_{ON}		0.3	1.0	ms	$I_F = 10\text{ mA}$, $V_L = \pm 20\text{ V}$
Turn-off Time	T_{OFF}		0.7	1.5	ms	$t = 10\text{ ms}$, $I_L = \pm 100\text{ mA}$

DATA CURVE

Load current vs. ambient temperature
Allowable ambient temperature:
-40°C to + 85°C

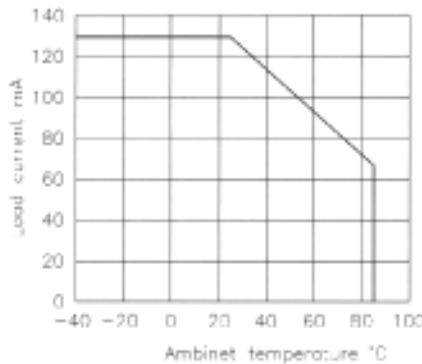

On resistance vs. ambient temperature
Across terminals 7 and 8 pin
LED current: 5 mA
Continuous load current: 130 mA(DC)

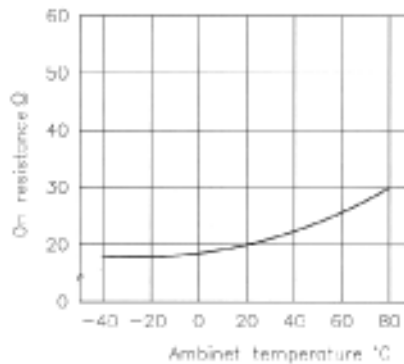

Turn on time vs. ambient temperature
Load voltage 350 V(DC)
LED current : 5 mA
Continuous load current: 130 mA(DC)

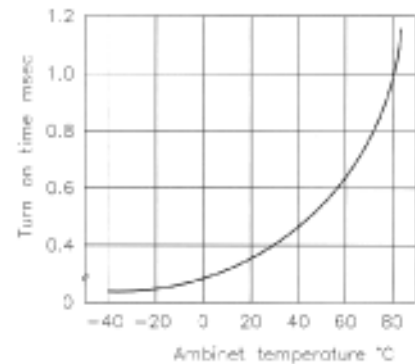

Turn off time vs. ambient temperature
LED current: 5 mA
Load voltage: 350V (DC)
Continuous load current: 130 mA(DC)

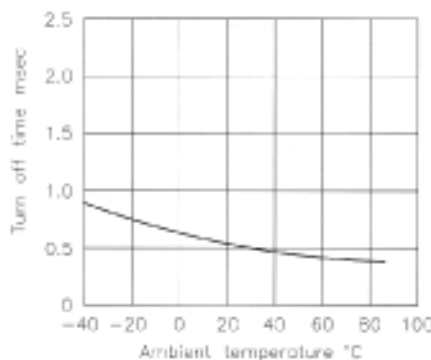

LED operate vs. ambient temperature
Load voltage: 350V (DC)
Continuous load current: 130 mA(DC)

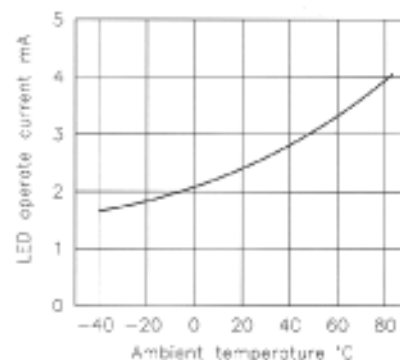

LED turn off current vs. ambient temperature
Load voltage: 350V (DC)
Continuous load current: 130 mA (DC)

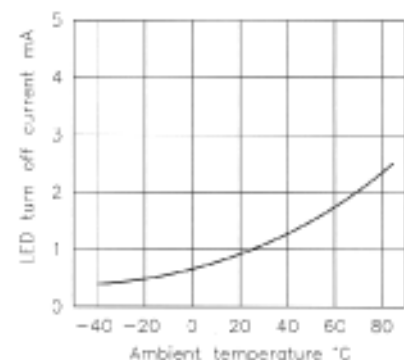

65 Shark River Road, Neptune, New Jersey 07753-7423

Tel: 732-922-6333 Fax: 732-922-6363 E-Mail: globalcomponents@msn.com