

TOP VIEW

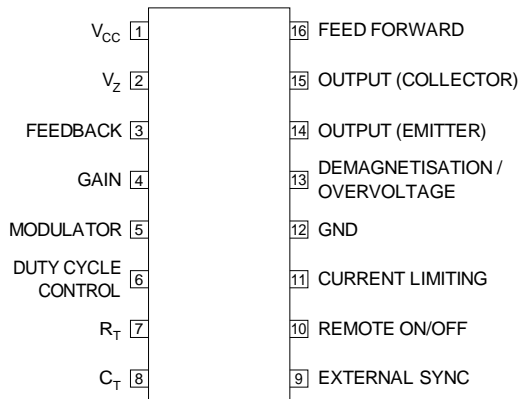

J Package – 16 Pin Ceramic DIP
N Package – 16 Pin Plastic DIP
D Package – 16 Pin Plastic (150) SOIC

SWITCHED-MODE POWER SUPPLY CONTROL CIRCUIT

FEATURES

- STABILISED POWER SUPPLY
- TEMPERATURE COMPENSATED REFERENCE SOURCE
- SAWTOOTH GENERATOR
- PULSE WIDTH MODULATOR
- REMOTE ON/OFF SWITCHING
- CURRENT LIMITING
- LOW SUPPLY VOLTAGE PROTECTION
- LOOP FAULT PROTECTION
- DEMAGNETISATION/OVERVOLTAGE PROTECTION
- MAXIMUM DUTY CYCLE CLAMP
- FEED FORWARD CONTROL
- EXTERNAL SYNCHRONISATION

Order Information

Part Number	J-Pack 16 Pin	N-Pack 16 Pin	D-16 16 Pin	Temp. Range	Note:
IP5560	✓			-55 to +125°C	To order, add the package identifier to the part number. eg. IP5560J
IP5560C	✓	✓	✓	0 to +70°C	IP5560CD-16

ABSOLUTE MAXIMUM RATINGS ($T_{case} = 25^{\circ}C$ unless otherwise stated)

SUPPLY		
Voltage Sourced		18V
Current Sourced		30mA
OUTPUT TRANSISTOR		
Output Current		40mA
Collector Voltage	(Pin 15)	18V
Maximum Emitter Voltage	(Pin 14)	5V
T_J	Operating Junction Temperature	See Ordering Information
T_{STG}	Storage Temperature Range	-65 to +150°C

DESCRIPTION

The IP5560 is a control circuit for use in switched mode power supplies. This single monolithic chip incorporates all the control and supervisory (protection) functions required in switched mode power supplies, including an internal temperature compensated reference source, internal reference, sawtooth generator, pulse width modulator, output stage and various protection circuits.

BLOCK DIAGRAM

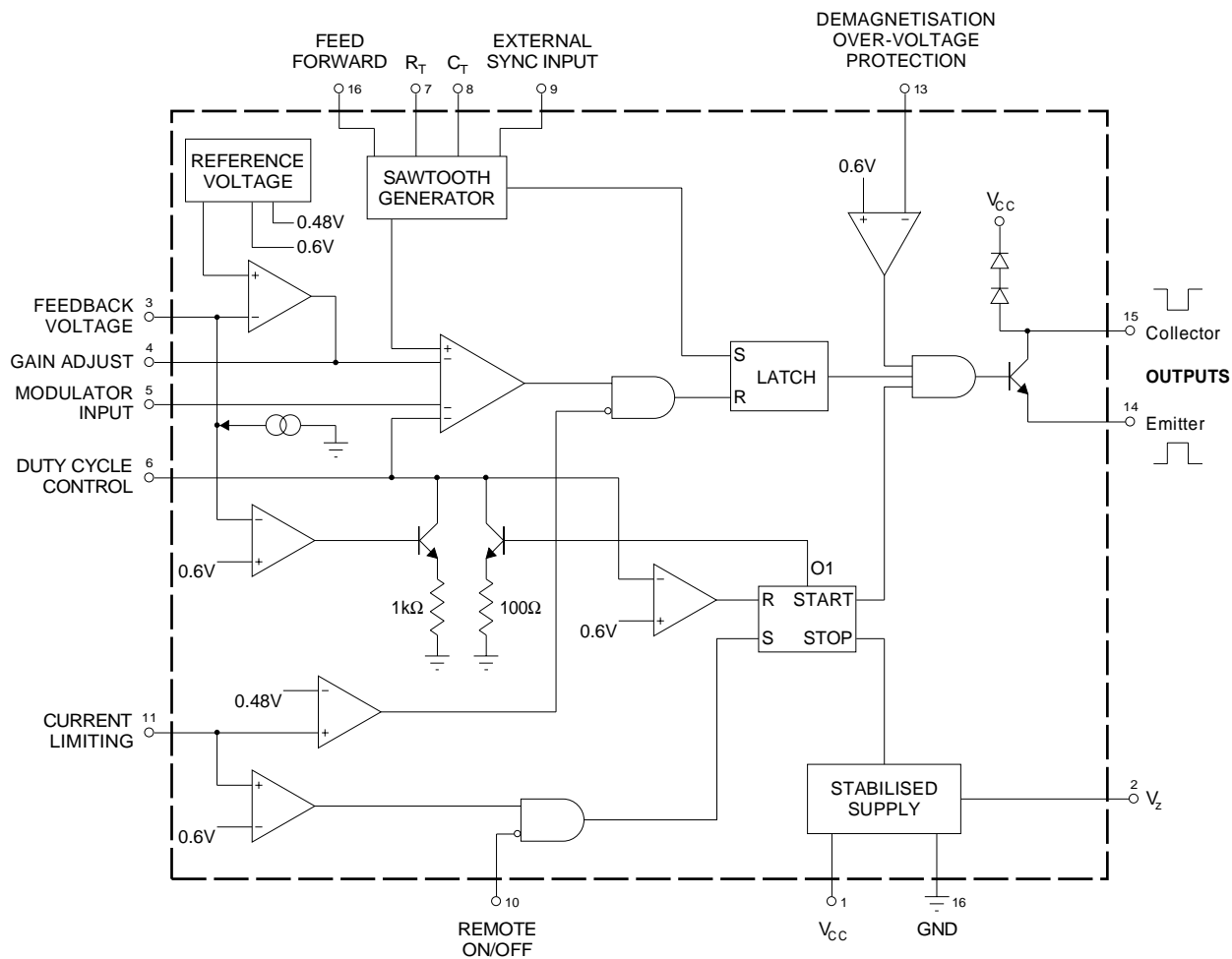

ELECTRICAL CHARACTERISTICS ($T_J = 25^\circ\text{C}$ unless otherwise stated)

Parameter	Test Conditions	IP5560			IP5560C			Units
		Min.	Typ.	Max.	Min.	Typ.	Max.	
REFERENCE SECTIONS								
Internal Reference Voltage (V_{REF})	$T_J = \text{Over Temp. Range}$	3.69	3.72	3.81	3.57	3.72	3.95	V
		3.65		3.85	3.53		4.00	
Temperature Coefficient of V_{REF}		±100			±100			ppm/°C
Internal Reference (V_Z)	$I_L = -7\text{mA}$	7.8	8.4	8.8	7.8	8.4	8.8	V
Temperature Coefficient of V_Z		±200			±200			ppm/°C
OSCILLATOR SECTION								
Frequency Range	$T_J = \text{Over Temp. Range}$	50		100k	50		100k	Hz
Initial Accuracy Oscillator	$R = 5\text{k}\Omega$	5			5			%
Duty Cycle Range	$f_O = 20\text{kHz}$	0-90	0-98		0-90	0-98		
MODULATOR								
Modulator Input Current	Voltage at Pin 5 = 2V $T_J = \text{Over Temp. Range}$		-0.2	-20		-0.2	-20	mA
SUPERVISORY FUNCTIONS								
Pin 6 Input Current	At 2V $T_J = \text{Over Temp. Range}$		-0.2	-20		-0.2	-20	µA
Pin 6 Duty Cycle Limit Control (for 50% Max. Duty Cycle)	$f = 15\text{kHz}$ to 50kHz $V_{pin6} = 0.4V_Z$	40	50	60	40	50	60	% Duty Cycle
Pin 1 Low Supply Voltage Protection Thresholds		8	9	10.5	8	9	10.5	V
Pin 3 Feedback Loop Protection Trip Thresholds		400	600	720	400	600	720	mV
Pin 3 Pull Up Current	At 2V	-7	-15	-35	-7	-15	-35	µA
Pin 13 Demagnetisation / Over- Voltage Protection Threshold		470	600	720	470	600	720	mV
Pin 13 Input Current	At 0.25V $T_J = \text{Over Temp. Range}$	-0.6	-10		-0.6	-10		µA
				-20			-20	
Pin 16 Feed Forward Duty Cycle Control	Voltage at Pin 16 = $2V_Z$	30	40	50	30	40	50	% Orig. Duty Cycle
Pin 16 Feed Forward Input Current	At 16V $V_{CC} = 18\text{V}$		0.2	5		0.2	5	µA

NOTES

- 1) Test Conditions: $V_{CC} = 12\text{V}$, $T_J = 25^\circ\text{C}$ unless otherwise stated
- 2) Tests marked $T_J = \text{Over Temp. Range}$ apply over the full temperature range
ie. $T_J = -55$ to $+125^\circ\text{C}$ for IP5560
 $T_J = 0$ to $+70^\circ\text{C}$ for IP5560C

ELECTRICAL CHARACTERISTICS ($T_J = 25^\circ\text{C}$ unless otherwise stated)

Parameter	Test Conditions	IP5560			IP5560C			Units
		Min.	Typ.	Max.	Min.	Typ.	Max.	
EXTERNAL SYNCHRONISATION								
Pin 9 Off		0		0.8	0		0.8	V
Pin 9 On		2		V_Z	2		V_Z	
Pin 9 Sink Current	Voltage at Pin 9 = 0V $T_J = \text{Over Temp. Range}$		-85	-125		-85	-125	μA
REMOTE ON/OFF								
Pin 10 Off		0		0.8	0		0.8	V
Pin 10 On		2		V_Z	2		V_Z	
Pin 10 Sink Current	Voltage at Pin 9 = 0V $T_J = \text{Over Temp. Range}$		-85	-125		-85	-125	μA
CURRENT LIMITING								
Pin 11 I_{IN}	Voltage at Pin 11 = 250mV		-2	-10		-2	-10	μA
Single Pulse Inhibit Delay	Inhibit Delay Time for 20% Overdrive at 30mA I_{OUT}		0.7	0.8		0.7	0.8	μs
Trip Levels: Shut Down, Slow Start		560	600	700	560	600	700	mV
Trip Levels: Current Limit		400	480	500	400	480	500	
ERROR AMPLIFIER								
Output Voltage Swing (V_{OH})		6.2		9.5	6.2		9.5	V
Output Voltage Swing (V_{OL})				0.7			0.7	
Open Loop Gain		54	60		54	60		dB
Feedback Resistor		10			10			k Ω
Small Signal Bandwidth			3			3		MHz
OUTPUT STAGE								
$V_{CE(sat)}$	$I_C = 40\text{mA}$			0.5			0.5	V
Output Current	(Pin 15)			40			40	mA
Max. Emitter Voltage	(Pin 14)	5			5			V
SUPPLY VOLTAGE/CURRENT								
Supply Current (I_{CC})	$I_Z = 0$, Voltage Fed, $V_{PIN6} = 0.5\text{V}$ $R_{PIN7} = 25\text{k}\Omega$ $T_J = \text{Over Temp. Range}$			10			10	mA
				15			15	
Supply Voltage (V_{CC})	$I_{CC} = 10\text{mA}$, Current Feed	20		24	19		24	V
	$I_{CC} = 30\text{mA}$, Current Feed	20		30	20		30	

NOTES

- 1) Test Conditions: $V_{CC} = 12\text{V}$, $T_J = 25^\circ\text{C}$ unless otherwise stated
- 2) Tests marked $T_J = \text{Over Temp. Range}$ apply over the full temperature range
 ie. $T_J = -55$ to $+125^\circ\text{C}$ for IP5560
 $T_J = 0$ to $+70^\circ\text{C}$ for IP5560C

TYPICAL PERFORMANCE CHARACTERISTICS — ERROR AMPLIFIER

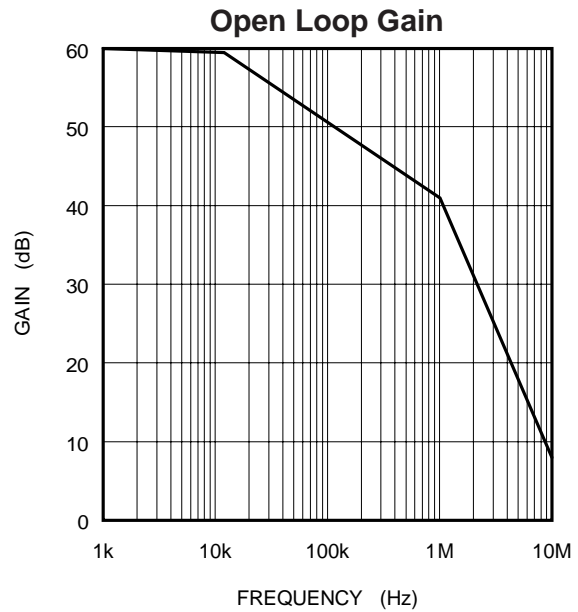
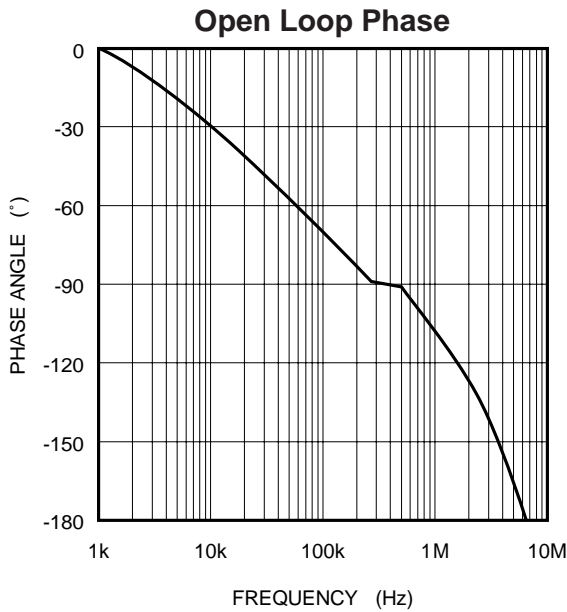

Transfer Curve of Pulse Width Modulator Duty Cycle vs Input Voltage

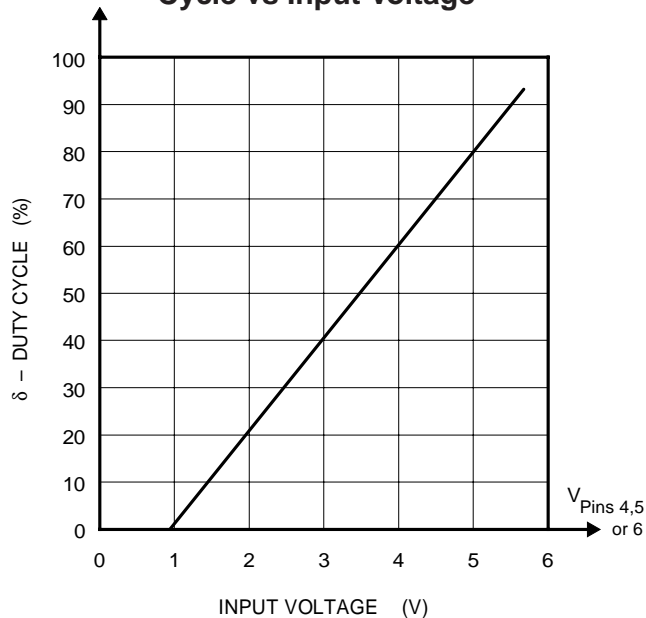

Regulation vs Error Amp Closed Loop Gain

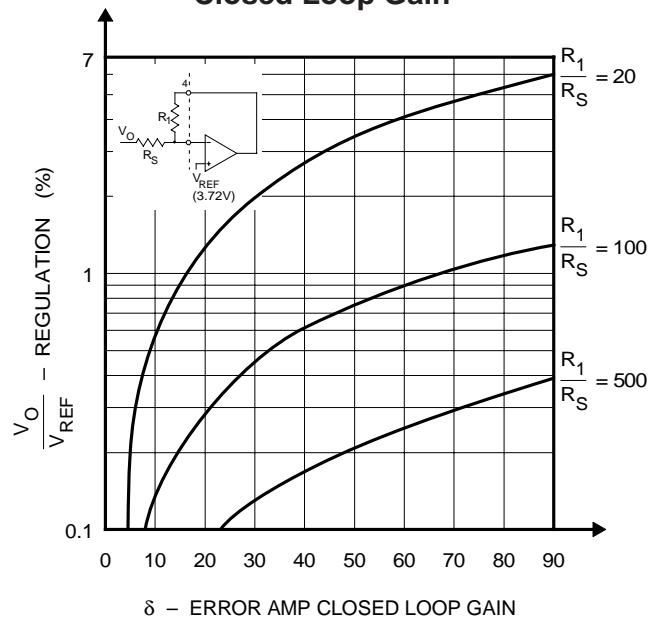

TYPICAL PERFORMANCE CHARACTERISTICS — ERROR AMPLIFIER

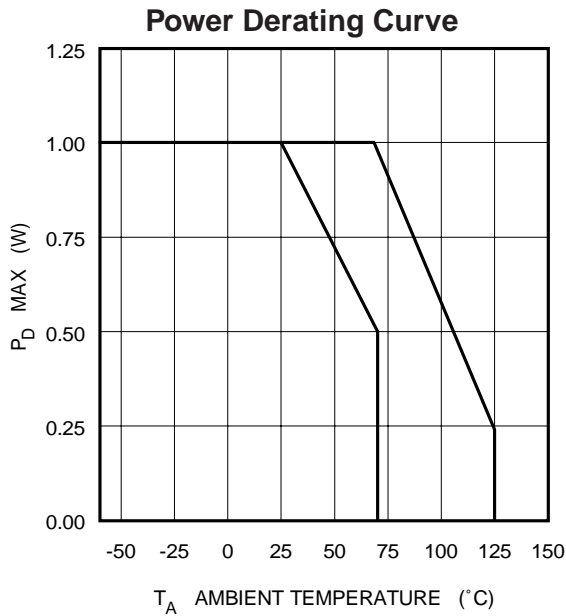

$$P_D = V_{CC} I_{CC} + (V_{CC} - V_Z) I_Z + [(V_{pin15} - V_{pin14}) I_{pin15} \times \delta]$$

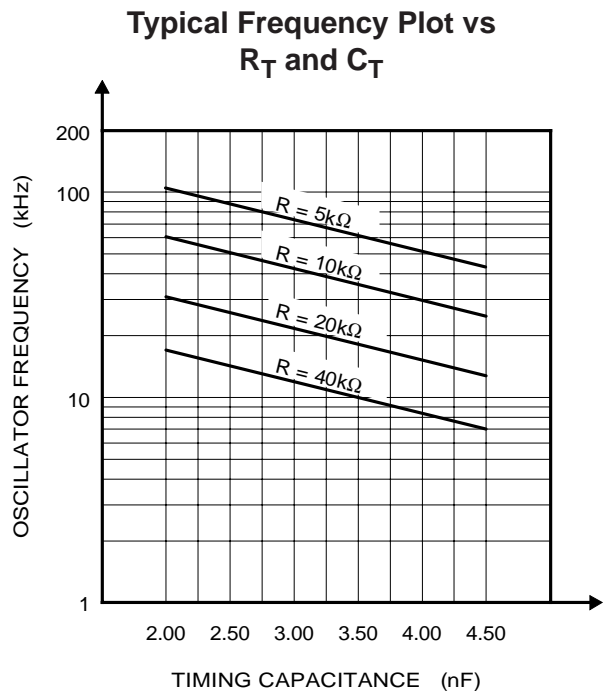
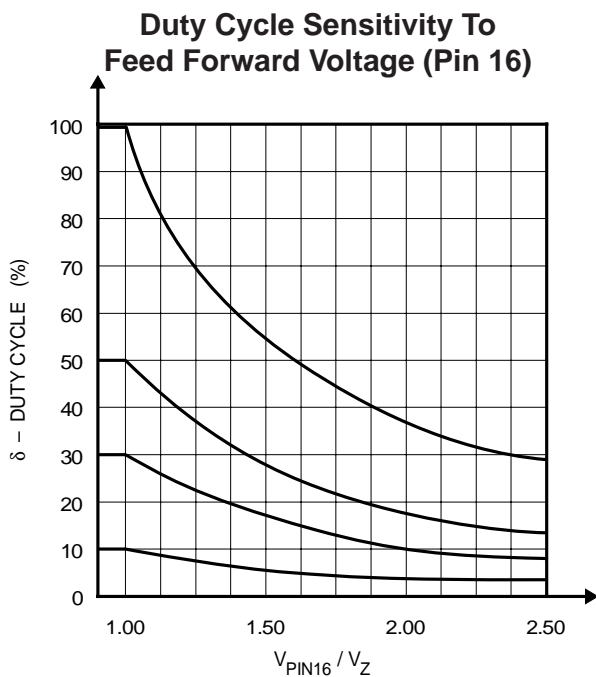
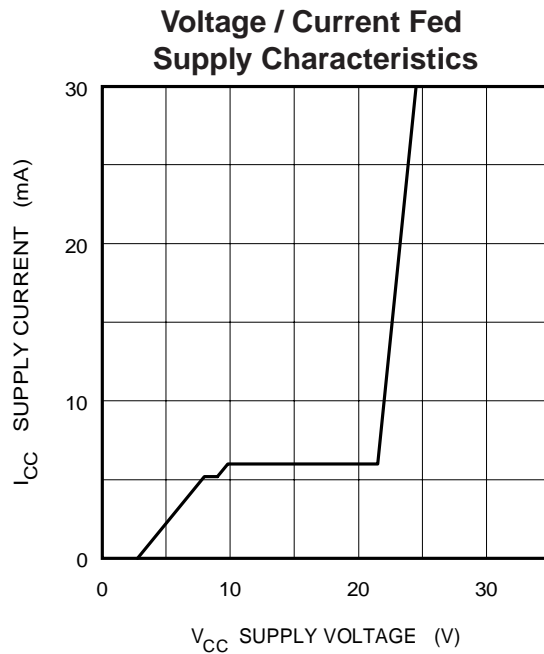

TYPICAL PERFORMANCE CHARACTERISTICS — ERROR AMPLIFIER

Soft Start Min. Duty Cycle vs $R_1 + R_2$

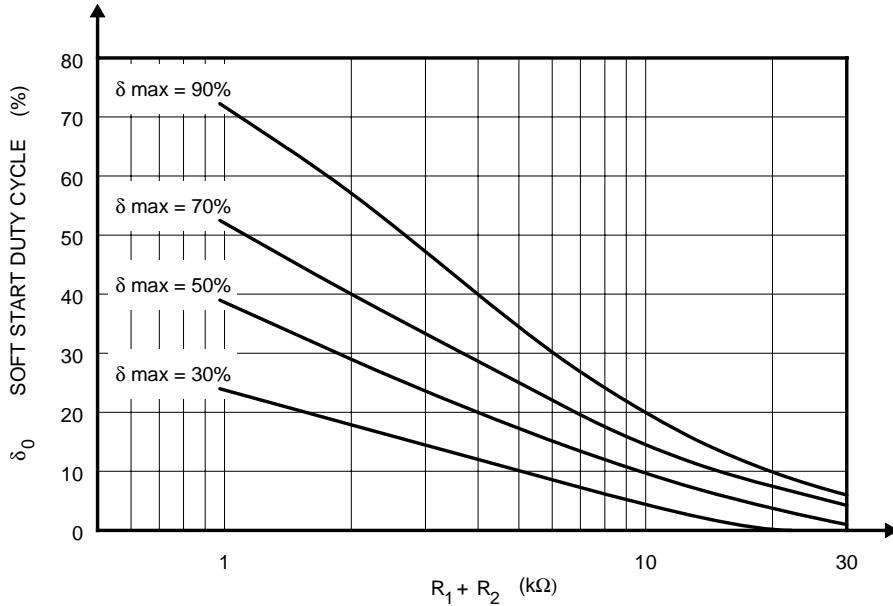

Current Fed Dropping Resistor

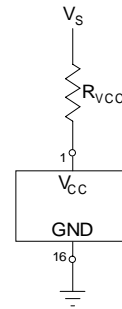

$$R_{VCC} = \frac{V_s - V_{CC}}{(10 \text{ to } 20 \text{ mA})}$$

See DC Electrical Characteristics For Current Feed V_{CC} Range

Graph for Determining δ_{max}

