

IW4020B

14 Stage Ripple-Carry Binary Counter/Divider
High-Voltage Silicon-Gate CMOS

The IW4020B is ripple-carry binary counter. All counter stages are master-slave flip-flops. The state of a counter advances one count on the negative transition of each input pulse; a high level on the RESET line resets the counter to its all zeros state. Schmitt trigger action on the input-pulse line permits unlimited rise and fall times.

- Operating Voltage Range: 3.0 to 18 V
- Maximum input current of 1 μ A at 18 V over full package-temperature range; 100 nA at 18 V and 25°C
- Noise margin (over full package temperature range):
 - 1.0 V min @ 5.0 V supply
 - 2.0 V min @ 10.0 V supply
 - 2.5 V min @ 15.0 V supply

ORDERING INFORMATION

IW4020BN Plastic DIP
IW4020BD SOIC

$T_A = -55^\circ$ to 125° C for all packages

LOGIC DIAGRAM

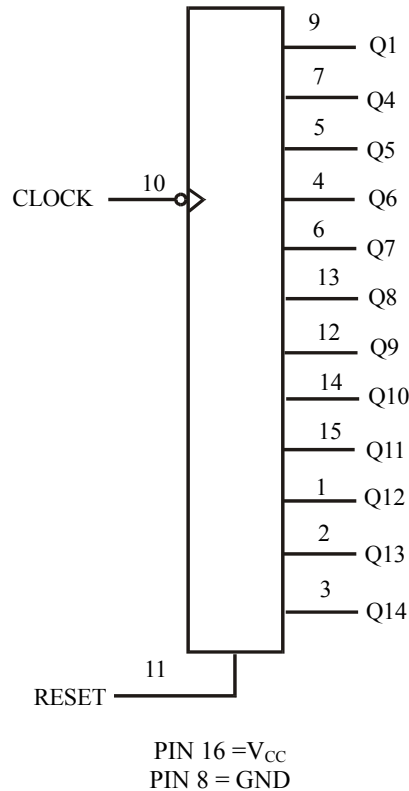

PIN ASSIGNMENT

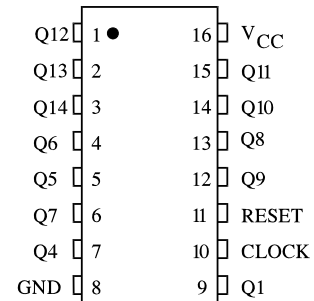

FUNCTION TABLE

Inputs		Output
Clock	Reset	Output state
	L	No change
	L	Advance to next state
X	H	All Outputs are low

H= high level
 L = low level
 X=don't care

MAXIMUM RATINGS*

Symbol	Parameter	Value	Unit
V_{CC}	DC Supply Voltage (Referenced to GND)	-0.5 to +20	V
V_{IN}	DC Input Voltage (Referenced to GND)	-0.5 to $V_{CC} + 0.5$	V
V_{OUT}	DC Output Voltage (Referenced to GND)	-0.5 to $V_{CC} + 0.5$	V
I_{IN}	DC Input Current, per Pin	± 10	mA
P_D	Power Dissipation in Still Air, Plastic DIP+ SOIC Package+	500* ¹	mW
P_{tot}	Power Dissipation per Output Transistor	100	mW
T_{stg}	Storage Temperature	-65 to +150	°C
T_L	Lead Temperature, 1 mm from Case for 10 Seconds (Plastic DIP or SOIC Package)	260	°C

*Maximum Ratings are those values beyond which damage to the device may occur. Functional operation should be restricted to the Recommended Operating Conditions.

*¹ For $T_A = -55$ to 100°C (package plastic DIP), for $T_A = -55$ to 65°C (package SOIC)

+Derating - Plastic DIP: - 12 mW/°C from 100°C to 125°C
SOIC Package: : - 7 mW/°C from 65°C to 125°C

RECOMMENDED OPERATING CONDITIONS

Symbol	Parameter	Min	Max	Unit
V_{CC}	DC Supply Voltage (Referenced to GND)	3.0	18	V
V_{IN}, V_{OUT}	DC Input Voltage, Output Voltage (Referenced to GND)	0	V_{CC}	V
T_A	Operating Temperature, All Package Types	-55	+125	°C

This device contains protection circuitry to guard against damage due to high static voltages or electric fields. However, precautions must be taken to avoid applications of any voltage higher than maximum rated voltages to this high-impedance circuit. For proper operation, V_{IN} and V_{OUT} should be constrained to the range $GND \leq (V_{IN} \text{ or } V_{OUT}) \leq V_{CC}$.

Unused inputs must always be tied to an appropriate logic voltage level (e.g., either GND or V_{CC}). Unused outputs must be left open.

DC ELECTRICAL CHARACTERISTICS (Voltages Referenced to GND)

Symbol	Parameter	Test Conditions	V _{CC} V	Guaranteed Limit			Unit
				-55°C	25°C	125°C	
V _{IH}	Minimum High-Level Input Voltage	V _{OUT} =0.5 V or V _{CC} - 0.5 V V _{OUT} =1.0 V or V _{CC} - 1.0 V V _{OUT} =1.5 V or V _{CC} - 1.5 V	5.0	3.5	3.5	3.5	V
			10	7.0	7.0	7.0	
			15	11.0	11.0	11.0	
V _{IL}	Maximum Low-Level Input Voltage	V _{OUT} =0.5 V or V _{CC} - 0.5 V V _{OUT} =1.0 V or V _{CC} - 1.0 V V _{OUT} =1.5 V or V _{CC} - 1.5 V	5.0	1.5	1.5	1.5	V
			10	3.0	3.0	3.0	
			15	4.0	4.0	4.0	
V _{OH}	Minimum High-Level Output Voltage	V _{IN} = GND or V _{CC}	5.0	4.95	4.95	4.95	V
			10	9.95	9.95	9.95	
			15	14.95	14.95	14.95	
V _{OL}	Maximum Low-Level Output Voltage	V _{IN} = GND or V _{CC}	5.0	0.05	0.05	0.05	V
			10	0.05	0.05	0.05	
			15	0.05	0.05	0.05	
I _{IN}	Maximum Input Leakage Current	V _{IN} = GND or V _{CC}	18	±0.1	±0.1	±1.0	µA
I _{CC}	Maximum Quiescent Supply Current (per Package)	V _{IN} = GND or V _{CC}	5.0	5	5	150	µA
			10	10	10	300	
			15	20	20	600	
			20	100	100	3000	
I _{OL}	Minimum Output Low (Sink) Current	V _{IN} = GND or V _{CC} U _{OL} =0.4 V U _{OL} =0.5 V U _{OL} =1.5 V	5.0	0.64	0.51	0.36	mA
			10	1.6	1.3	0.9	
			15	4.2	3.4	2.4	
I _{OH}	Minimum Output High (Source) Current	V _{IN} = GND or V _{CC} U _{OH} =2.5 V U _{OH} =4.6 V U _{OH} =9.5 V U _{OH} =13.5 V	5.0	-2.0	-1.6	-1.15	mA
			5.0	-0.64	-0.51	-0.36	
			10	-1.6	-1.3	-0.9	
			15	-4.2	-3.4	-2.4	

AC ELECTRICAL CHARACTERISTICS ($C_L=50$ pF, $R_L=200$ k Ω , $t_r=t_f=20$ ns)

Symbol	Parameter	V _{CC} V	Guaranteed Limit			Unit
			-55°C	25°C	125°C	
f _{max}	Maximum Clock Frequency (Figure 1)	5.0 10 15		3.5 8 12		MHz
t _{PLH} , t _{PHL}	Maximum Propagation Delay, Clock to Q1 (Figure 1)	5.0 10 15	720 320 260	360 160 130	720 320 260	ns
t _{PLH} , t _{PHL}	Maximum Propagation Delay, Q _n to Q _{n+1} (Figure 2)	5.0 10 15	660 160 120	330 80 60	660 160 120	ns
t _{PHL}	Maximum Propagation Delay, Reset to Any Q (Figure 3)	5.0 10 15	560 240 200	280 120 100	560 240 200	ns
t _{TLH} , t _{THL}	Maximum Output Transition Time, Any Output (Figure 1)	5.0 10 15	400 200 160	200 100 80	400 200 160	ns
C _{IN}	Maximum Input Capacitance	-		7.5		pF

TIMING REQUIREMENTS ($C_L=50$ pF, $R_L=200$ k Ω , $t_r=t_f=20$ ns)

Symbol	Parameter	V _{CC} V	Guaranteed Limit			Unit
			-55°C	25°C	125°C	
t _w	Minimum Pulse Width, Clock (Figure 1)	5.0 10 15	280 120 80	140 60 40	280 120 80	ns
t _w	Minimum Pulse Width, Reset (Figure 3)	5.0 10 15	400 160 120	200 80 60	400 160 120	ns
t _{rem}	Minimum Removal Time, Reset(Figure 3)	5.0 10 15	700 300 200	350 150 100	700 300 200	ns
t _r , t _f	Maximum Input Rise and Fall Times, Clock (Figure 1)	5.0 10 15	Unlimited			ns

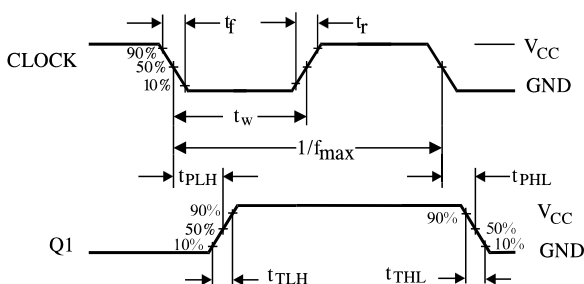

Figure 1. Switching Waveforms

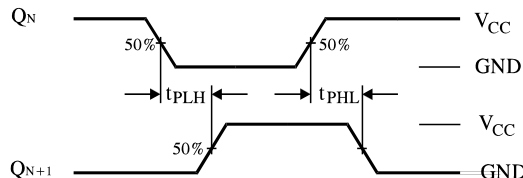

Figure 2. Switching Waveforms

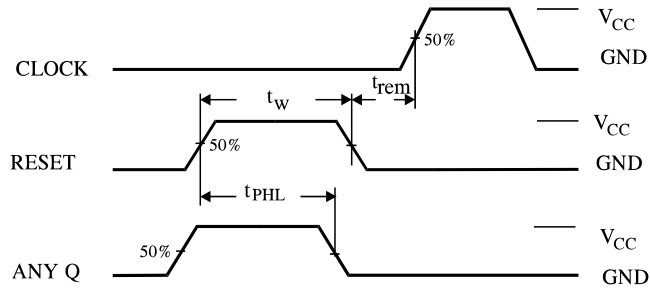
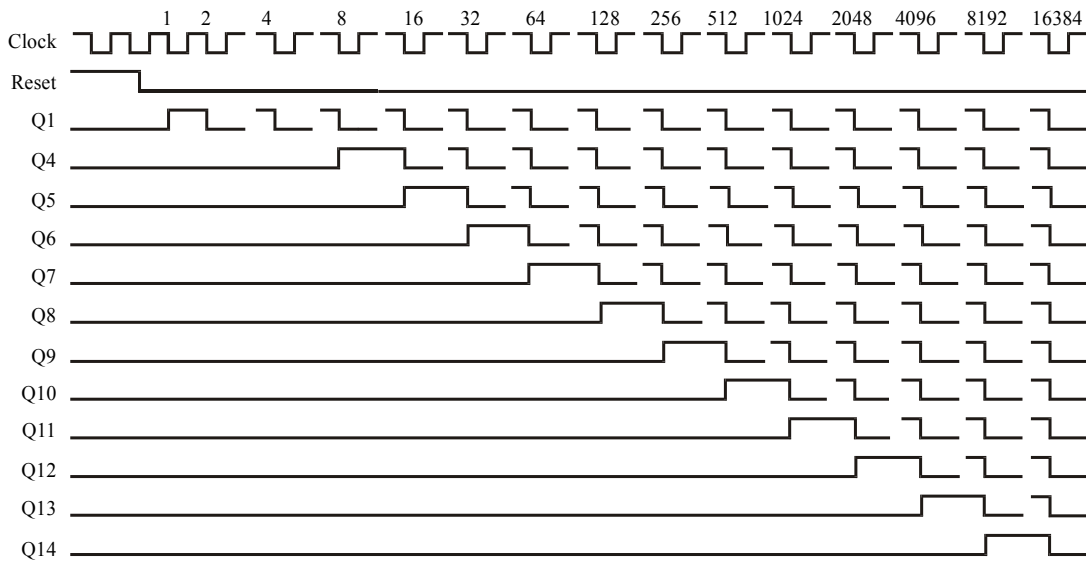
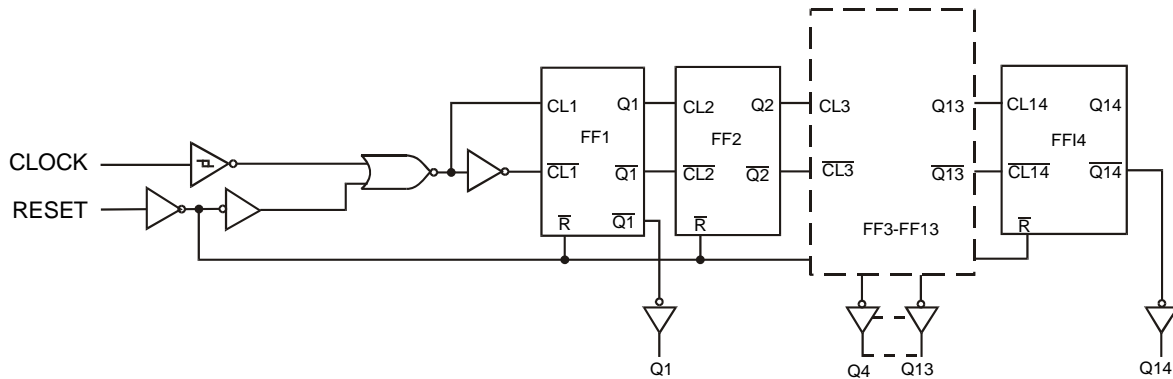

Figure 3. Switching Waveforms

TIMING DIAGRAM



EXPANDED LOGIC DIAGRAM



**N SUFFIX PLASTIC
(MS - 001BB)**

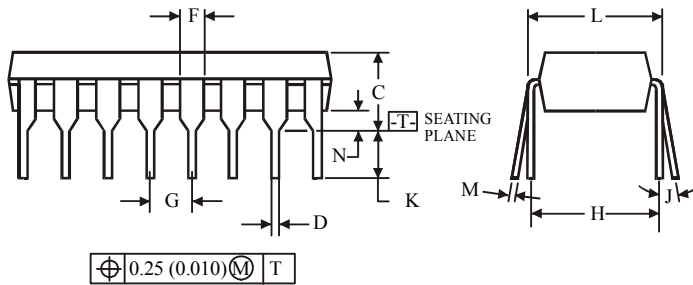
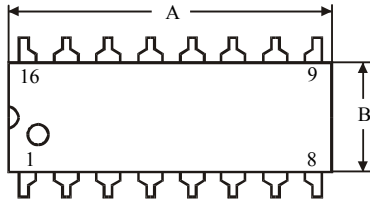
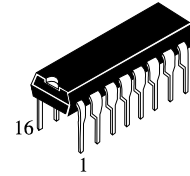

Symbol	Dimensions, mm	
	MIN	MAX
A	18.67	19.69
B	6.10	7.11
C		5.33
D	0.36	0.56
F	1.14	1.78
G	2.54	
H	7.62	
J	0°	10°
K	2.92	3.81
L	7.62	8.26
M	0.20	0.36
N	0.38	

NOTES:

- Dimensions "A", "B" do not include mold flash or protrusions. Maximum mold flash or protrusions 0.25 mm (0.010) per side.

**D SUFFIX SOIC
(MS - 012AC)**

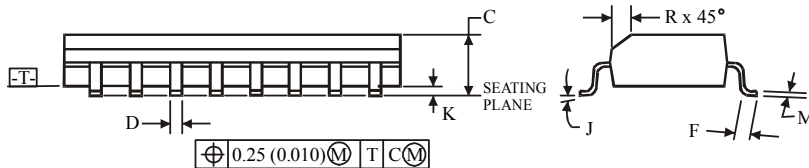
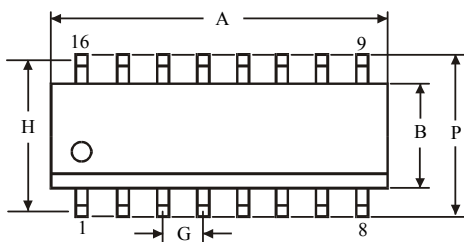
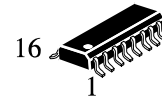

Symbol	Dimensions, mm	
	MIN	MAX
A	9.80	10.0
B	3.80	4.00
C	1.35	1.75
D	0.33	0.51
F	0.40	1.27
G	1.27	
H	5.72	
J	0°	8°
K	0.10	0.25
M	0.19	0.25
P	5.80	6.20
R	0.25	0.50

NOTES:

- Dimensions A and B do not include mold flash or protrusion.
- Maximum mold flash or protrusion 0.15 mm (0.006) per side for A, for B - 0.25 mm (0.010) per side.