

LM50

SOT-23 Single-Supply Centigrade Temperature Sensor

General Description

The LM50 is a precision integrated-circuit temperature sensor that can sense a -40°C to $+125^{\circ}\text{C}$ temperature range using a single positive supply. The LM50's output voltage is linearly proportional to Celsius (Centigrade) temperature ($+10\text{ mV}/^{\circ}\text{C}$) and has a DC offset of $+500\text{ mV}$. The offset allows reading negative temperatures without the need for a negative supply. The ideal output voltage of the LM50 ranges from $+100\text{ mV}$ to $+1.75\text{V}$ for a -40°C to $+125^{\circ}\text{C}$ temperature range. The LM50 does not require any external calibration or trimming to provide accuracies of $\pm 3^{\circ}\text{C}$ at room temperature and $\pm 4^{\circ}\text{C}$ over the full -40°C to $+125^{\circ}\text{C}$ temperature range. Trimming and calibration of the LM50 at the wafer level assure low cost and high accuracy. The LM50's linear output, $+500\text{ mV}$ offset, and factory calibration simplify circuitry required in a single supply environment where reading negative temperatures is required. Because the LM50's quiescent current is less than $130\text{ }\mu\text{A}$, self-heating is limited to a very low 0.2°C in still air.

Applications

- Computers
- Disk Drives
- Battery Management
- Automotive
- FAX Machines
- Printers
- Portable Medical Instruments
- HVAC
- Power Supply Modules

Features

- Calibrated directly in degree Celsius (Centigrade)
- Linear $+10.0\text{ mV}/^{\circ}\text{C}$ scale factor
- $\pm 2^{\circ}\text{C}$ accuracy guaranteed at $+25^{\circ}\text{C}$
- Specified for full -40° to $+125^{\circ}\text{C}$ range
- Suitable for remote applications
- Low cost due to wafer-level trimming
- Operates from 4.5V to 10V
- Less than $130\text{ }\mu\text{A}$ current drain
- Low self-heating, less than 0.2°C in still air
- Nonlinearity less than 0.8°C over temp

Connection Diagram

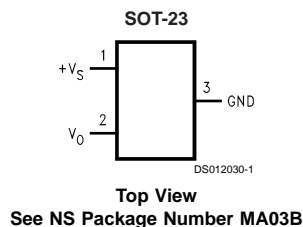

Order Number	SOT-23 Device Marking	Supplied As
LM50BIM3	T5B	1000 Units on Tape and Reel
LM50CIM3	T5C	1000 Units on Tape and Reel
LM50BIM3X	T5B	3000 Units on Tape and Reel
LM50CIM3X	T5C	3000 Units on Tape and Reel

Typical Application

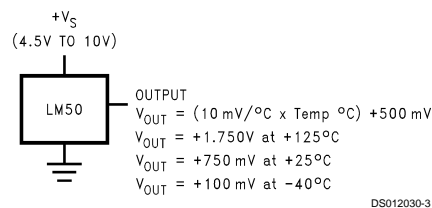

FIGURE 1. Full-Range Centigrade Temperature Sensor (-40°C to $+125^{\circ}\text{C}$)

Absolute Maximum Ratings (Note 1)

Supply Voltage	+12V to -0.2V
Output Voltage	(+V _S + 0.6V) to -1.0V
Output Current	10 mA
Storage Temperature	-65°C to +150°C
Lead Temperature:	
SOT Package (Note 2):	
Vapor Phase (60 seconds)	215°C
Infrared (15 seconds)	220°C
T _{JMAX} , Maximum	
Junction Temperature	150°C

ESD Susceptibility (Note 3):

Human Body Model	2000V
Machine Model	250V

Operating Ratings (Note 1)

Specified Temperature Range:	T _{MIN} to T _{MAX}
LM50C	-40°C to +125°C
LM50B	-25°C to +100°C
Operating Temperature Range	-40°C to +150°C
θ _{JA} (Note 4)	450°C/W
Supply Voltage Range (+V _S)	+4.5V to +10V

Electrical Characteristics

Unless otherwise noted, these specifications apply for V_S = +5 V_{DC} and I_{LOAD} = +0.5 μA, in the circuit of *Figure 1*. **Boldface limits apply for the specified T_A = T_J = T_{MIN} to T_{MAX}**; all other limits T_A = T_J = +25°C, unless otherwise noted.

Parameter	Conditions	LM50B		LM50C		Units (Limit)
		Typical	Limit (Note 5)	Typical	Limit (Note 5)	
Accuracy (Note 6)	T _A = +25°C		±2.0		±3.0	°C (max)
	T _A = T _{MAX}		±3.0		±4.0	°C (max)
	T _A = T _{MIN}		+3.0, -3.5		±4.0	°C (max)
Nonlinearity (Note 7)			±0.8		±0.8	°C (max)
Sensor Gain (Average Slope)			+9.7		+9.7	mV/°C (min)
			+10.3		+10.3	mV/°C (max)
Output Resistance		2000	4000	2000	4000	Ω (max)
Line Regulation (Note 8)	+4.5V ≤ V _S ≤ +10V		±0.8		±0.8	mV/V (max)
			±1.2		±1.2	mV/V (max)
Quiescent Current (Note 9)	+4.5V ≤ V _S ≤ +10V		130		130	μA (max)
			180		180	μA (max)
Change of Quiescent Current (Note 9)	+4.5V ≤ V _S ≤ +10V		2.0		2.0	μA (max)
Temperature Coefficient of Quiescent Current			+1.0		+2.0	μA/°C
Long Term Stability (Note 10)	T _J = 125°C, for 1000 hours		±0.08		±0.08	°C

Note 1: Absolute Maximum Ratings indicate limits beyond which damage to the device may occur. DC and AC electrical specifications do not apply when operating the device beyond its rated operating conditions.

Note 2: See AN-450 "Surface Mounting Methods and Their Effect on Product Reliability" or the section titled "Surface Mount" found in a current National Semiconductor Linear Data Book for other methods of soldering surface mount devices.

Note 3: Human body model, 100 pF discharged through a 1.5 kΩ resistor. Machine model, 200 pF discharged directly into each pin.

Note 4: Thermal resistance of the SOT-23 package is specified without a heat sink, junction to ambient.

Note 5: Limits are guaranteed to National's AOQL (Average Outgoing Quality Level).

Note 6: Accuracy is defined as the error between the output voltage and 10mV/°C times the device's case temperature plus 500 mV, at specified conditions of voltage, current, and temperature (expressed in °C).

Note 7: Nonlinearity is defined as the deviation of the output-voltage-versus-temperature curve from the best-fit straight line, over the device's rated temperature range.

Note 8: Regulation is measured at constant junction temperature, using pulse testing with a low duty cycle. Changes in output due to heating effects can be computed by multiplying the internal dissipation by the thermal resistance.

Note 9: Quiescent current is defined in the circuit of *Figure 1*.

Note 10: For best long-term stability, any precision circuit will give best results if the unit is aged at a warm temperature, and/or temperature cycled for at least 46 hours before long-term life test begins. This is especially true when a small (Surface-Mount) part is wave-soldered; allow time for stress relaxation to occur. The majority of the drift will occur in the first 1000 hours at elevated temperatures. The drift after 1000 hours will not continue at the first 1000 hour rate.

Typical Performance Characteristics To generate these curves the LM50 was mounted to a printed circuit board as shown in *Figure 2*.

Thermal Resistance Junction to Air

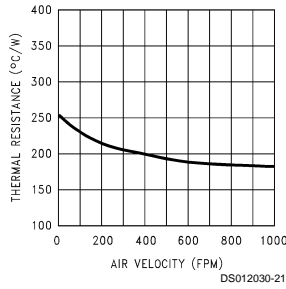

Thermal Time Constant

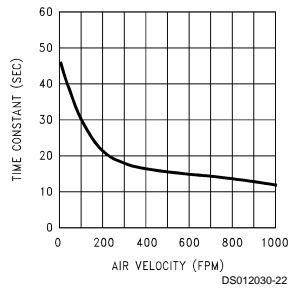

Thermal Response in Still Air with Heat Sink (*Figure 2*)

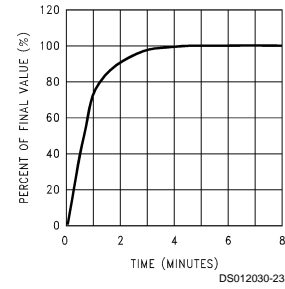

Thermal Response in Stirred Oil Bath with Heat Sink

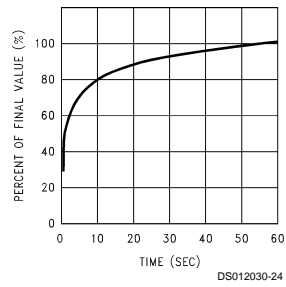

Start-Up Voltage vs Temperature

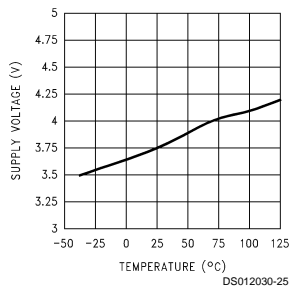

Thermal Response in Still Air without a Heat Sink

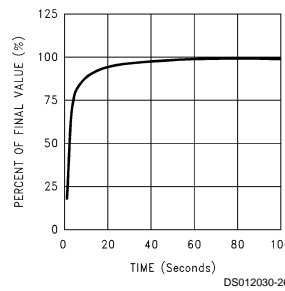

Quiescent Current vs Temperature (*Figure 1*)

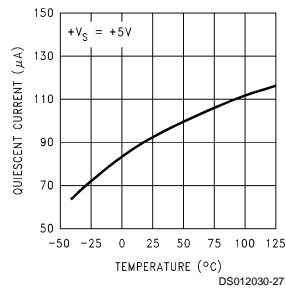

Accuracy vs Temperature

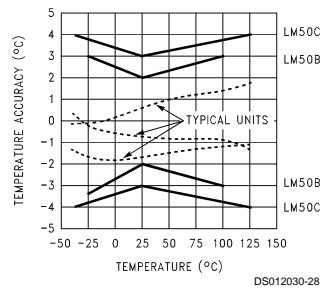

Noise Voltage

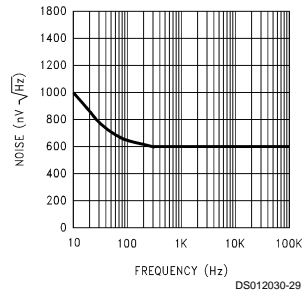

Typical Performance Characteristics To generate these curves the LM50 was mounted to a printed circuit board as shown in Figure 2. (Continued)

Supply Voltage vs Supply Current

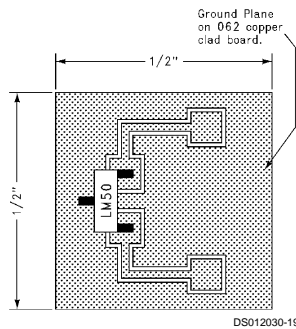
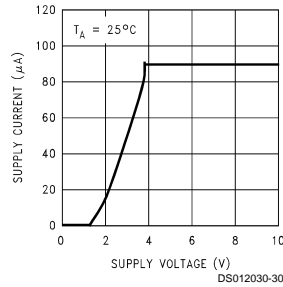

FIGURE 2. Printed Circuit Board Used for Heat Sink to Generate All Curves. 1/2" Square Printed Circuit Board with 2 oz. Foil or Similar

1.0 Mounting

The LM50 can be applied easily in the same way as other integrated-circuit temperature sensors. It can be glued or cemented to a surface and its temperature will be within about 0.2°C of the surface temperature.

This presumes that the ambient air temperature is almost the same as the surface temperature; if the air temperature were much higher or lower than the surface temperature, the actual temperature of the LM50 die would be at an intermediate temperature between the surface temperature and the air temperature.

To ensure good thermal conductivity the backside of the LM50 die is directly attached to the GND pin. The lands and traces to the LM50 will, of course, be part of the printed circuit board, which is the object whose temperature is being measured. These printed circuit board lands and traces will not cause the LM50s temperature to deviate from the desired temperature.

Alternatively, the LM50 can be mounted inside a sealed-end metal tube, and can then be dipped into a bath or screwed into a threaded hole in a tank. As with any IC, the LM50 and accompanying wiring and circuits must be kept insulated and dry, to avoid leakage and corrosion. This is especially true if the circuit may operate at cold temperatures where condensation can occur. Printed-circuit coatings and varnishes such

Start-Up Response

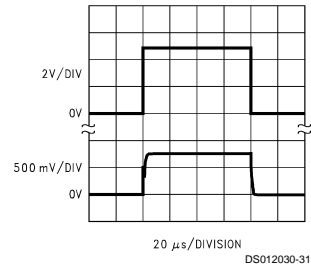

as Humiseal and epoxy paints or dips are often used to ensure that moisture cannot corrode the LM50 or its connections.

Temperature Rise of LM50 Due to Self-Heating (Thermal Resistance, θ_{JA})

	SOT-23 no heat sink*	SOT-23 small heat fin**
Still air	450°C/W	260°C/W
Moving air		180°C/W

* Part soldered to 30 gauge wire.
** Heat sink used is 1/2" square printed circuit board with 2 oz. foil with part attached as shown in Figure 2.

2.0 Capacitive Loads

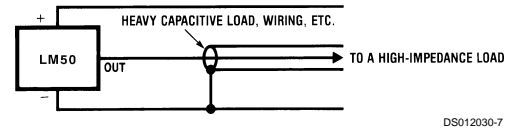

FIGURE 3. LM50 No Decoupling Required for Capacitive Load

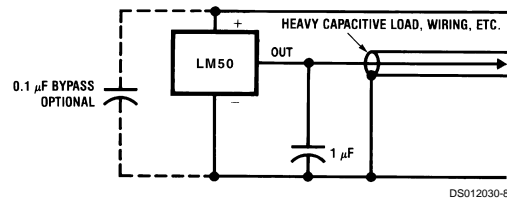

FIGURE 4. LM50C with Filter for Noisy Environment

The LM50 handles capacitive loading very well. Without any special precautions, the LM50 can drive any capacitive load. The LM50 has a nominal 2 kΩ output impedance (as can be seen in the block diagram). The temperature coefficient of the output resistors is around 1300 ppm/°C. Taking into account this temperature coefficient and the initial tolerance of the resistors the output impedance of the LM50 will not exceed 4 kΩ. In an extremely noisy environment it may be necessary to add some filtering to minimize noise pickup. It is recommended that 0.1 µF be added from V_{IN} to GND to by-

2.0 Capacitive Loads (Continued)

pass the power supply voltage, as shown in *Figure 4*. In a noisy environment it may be necessary to add a capacitor from the output to ground. A 1 μF output capacitor with the 4 k Ω output impedance will form a 40 Hz lowpass filter. Since

the thermal time constant of the LM50 is much slower than the 25 ms time constant formed by the RC, the overall response time of the LM50 will not be significantly affected. For much larger capacitors this additional time lag will increase the overall response time of the LM50.

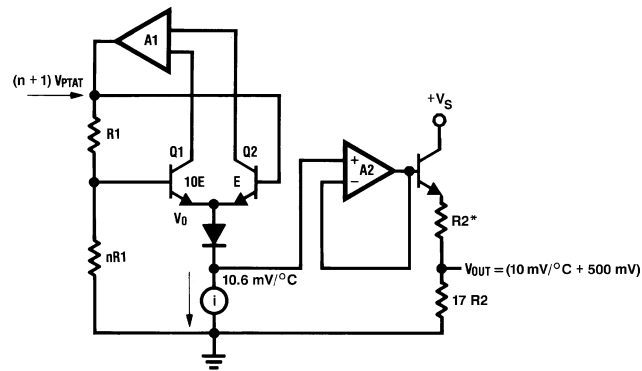

DS012030-17

*R2 = 2k with a typical 1300 ppm/ $^{\circ}\text{C}$ drift.

FIGURE 5. Block Diagram

3.0 Typical Applications

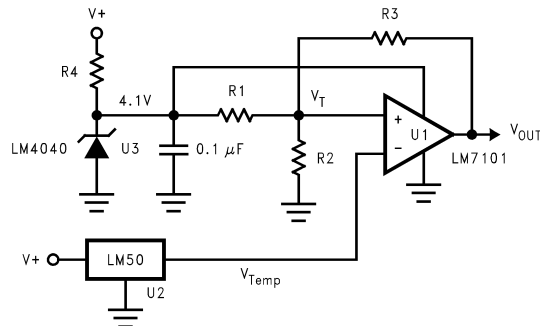

DS012030-11

FIGURE 6. Centigrade Thermostat/Fan Controller

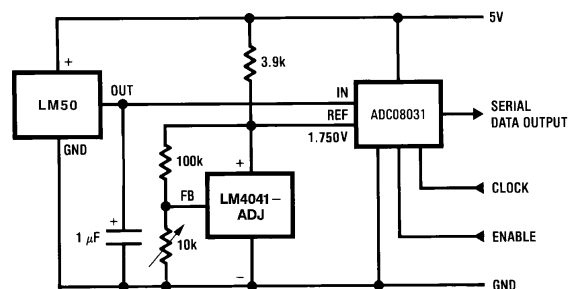

DS012030-13

FIGURE 7. Temperature To Digital Converter (Serial Output) (+125 $^{\circ}\text{C}$ Full Scale)

