

High-accuracy
Low current consumption

General-purpose
RESET IC

BD47XXG series

● Description

BD47XXG is a series of RESET ICs developed to prevent system error at transient state when the power of CPU and logic circuit switches ON/OFF or shutdown. These ICs consist of Power, GND, and reset output to detect power supply voltage of various systems and to output reset signal. These ICs are more practical for portable products because of their ultra-small package and low current consumption.

● Features

- 1) Detection voltage: 0.1V step line up 1.9~4.6V(Typ.)
- 2) High-accuracy voltage detection $V_s \pm 2\%$ (Max.)
- 3) Low current consumption
- 4) "L" reset output of open collector
- 5) Small SMP5 package

● Applications

Portable products, Equipments with CPU and logic circuit

● Series characteristics

Part No.	Detection voltage Vs (V)			Consumption current (μA Typ.)		Hysteresis voltage (mV)	Operating output current (mA)	Package
	Min	Typ.	Max.	ICCL	ICCH			
BD4746G	4.508	4.600	4.692	1.5	1.6	50	15	SMP5
BD4745G	4.410	4.500	4.590	1.5	1.6	50	15	SMP5
BD4744G	4.312	4.400	4.488	1.5	1.6	50	15	SMP5
BD4743G	4.214	4.300	4.386	1.5	1.6	50	15	SMP5
BD4742G	4.116	4.200	4.284	1.5	1.6	50	15	SMP5
BD4741G	4.018	4.100	4.182	1.5	1.6	50	15	SMP5
BD4740G	3.920	4.000	4.080	1.5	1.6	50	15	SMP5
BD4739G	3.822	3.900	3.978	1.5	1.6	50	15	SMP5
BD4738G	3.724	3.800	3.876	1.5	1.6	50	15	SMP5
BD4737G	3.626	3.700	3.774	1.5	1.6	50	15	SMP5
BD4736G	3.528	3.600	3.672	1.5	1.6	50	15	SMP5
BD4735G	3.430	3.500	3.570	1.5	1.6	50	15	SMP5
BD4734G	3.332	3.400	3.468	1.5	1.6	50	15	SMP5
BD4733G	3.234	3.300	3.366	1.5	1.6	50	15	SMP5
BD4732G	3.136	3.200	3.264	1.5	1.6	50	15	SMP5
BD4731G	3.038	3.100	3.162	1.5	1.6	50	15	SMP5
BD4730G	2.940	3.000	3.060	1.5	1.6	50	15	SMP5
BD4729G	2.842	2.900	2.958	1.5	1.6	50	15	SMP5
BD4728G	2.744	2.800	2.856	1.5	1.6	50	15	SMP5
BD4727G	2.646	2.700	2.754	1.5	1.6	50	15	SMP5
BD4726G	2.548	2.600	2.652	1.5	1.6	50	15	SMP5
BD4725G	2.450	2.500	2.550	1.5	1.6	50	15	SMP5
BD4724G	2.352	2.400	2.448	1.5	1.6	50	15	SMP5
BD4723G	2.254	2.300	2.346	1.5	1.6	50	15	SMP5
BD4722G	2.156	2.200	2.244	1.5	1.6	50	15	SMP5
BD4721G	2.058	2.100	2.142	1.5	1.6	50	15	SMP5
BD4720G	1.960	2.000	2.040	1.5	1.6	50	15	SMP5
BD4719G	1.862	1.900	1.938	1.5	1.6	50	15	SMP5

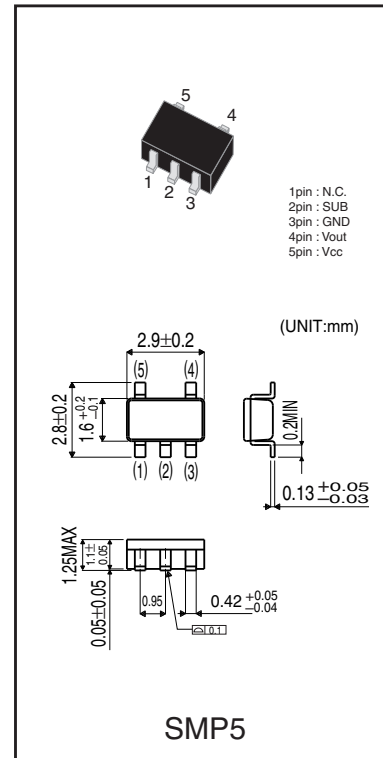

● Absolute Maximum Ratings(Ta=25°C)

Parameter	Symbol	Limits	Unit
Power supply voltage	Vcc	-0.3 ~ +10	V
Output voltage	Po	-0.3 ~ +10	V
Power dissipation (SMP5)	Pd	150 *	mW
Operating temperature range	Topr	-20 ~ +75	°C
Storage temperature range	Tstg	-40 ~ +125	°C

Note) The ratings shown above indicate breakdown limit of the pin and should not be regarded as the values that guarantee the operation.

* Derating : 1.5mW/°C for operation above Ta=25°C

● Electrical characteristics(Unless otherwise noted; Ta=25°C)

Parameter	Symbol	Min.	Typ.	Max.	Unit	Conditions
Detection voltage	Vs	-2%	1.9~4.6	+2%	V	RL=4.7kΩ, Vcc=HÆL
Detection voltage temperature coefficient	Vs/ΔT	—	±0.01	—	%/°C	RL=4.7KΩ, Ta=-20~+75°C
Hysteresis voltage	ΔVs	30	50	100	mV	RL=4.7KΩ, Vcc=LÆHÆL
"H" transfer delay time	TPLH	—	20	50	μS	CL=100PF, RL=4.7KΩ *1
"L" transfer delay time	TPHL	—	60	120	μS	CL=100PF, RL=4.7KΩ *2
"L" output voltage	VOL	—	0.1	0.4	V	Vcc=VsMIN.-0.05V, RL=4.7KΩ
Circuit current (At ON mode)	Icc1	—	1.5	3.0	μA	Vcc=VsMIN.-0.05V, RL=∞
Circuit current (At OFF mode)	Icc2	—	1.6	3.2	μA	Vcc=VsTYP./0.85V, RL=∞
Operating limit voltage	VOPL	—	0.65	0.85	V	RL=4.7KΩ, VOL≥0.4V
Output leak current	IL	—	—	0.1	μA	Vcc=Vout=10V
"L" output current	IOL	3.0	15.0	—	mA	Vo=0.4V, Vcc=VsMIN.-0.05V

*1 TPLH : Vcc=(Vs typ.-0.4V)/Æ(Vs typ.+0.4V)

*2 TPHL : Vcc=(Vs typ.+0.4V)/Æ(Vs typ.-0.4V)

● Timing waveform

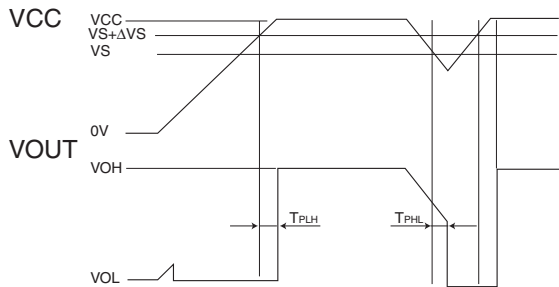

● Transfer delay time measurement circuit

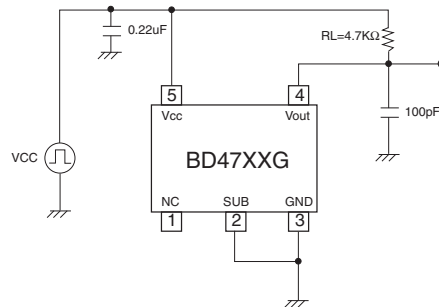

● Application Circuit

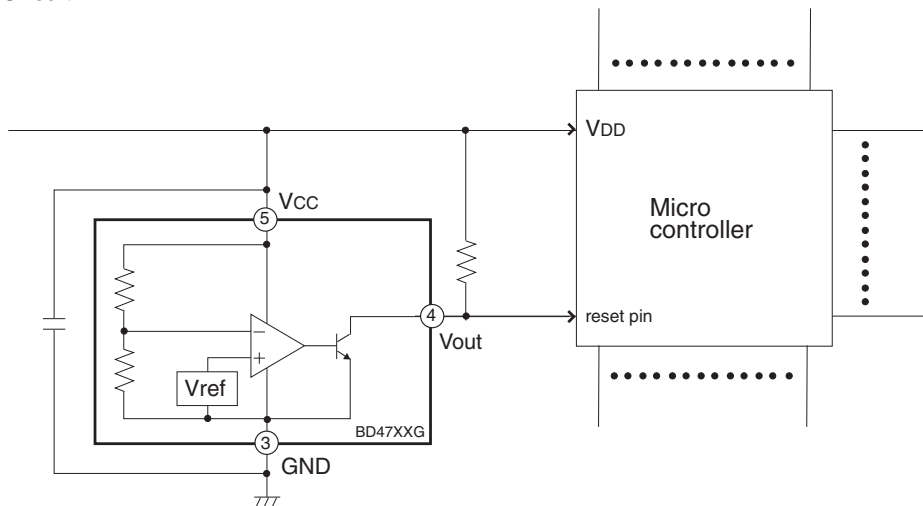

● Characteristic diagram and Measurement circuit (When BD4729G is measured.)

Current consumption

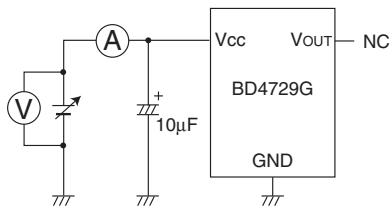
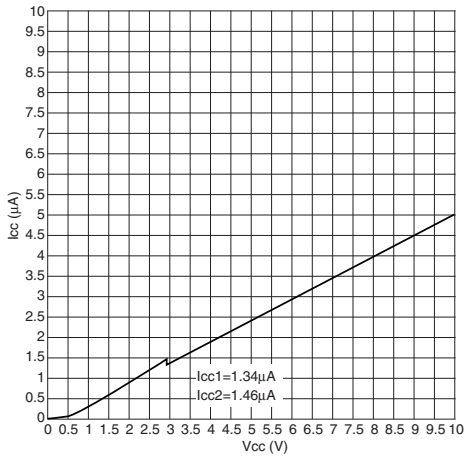

I/O characteristic

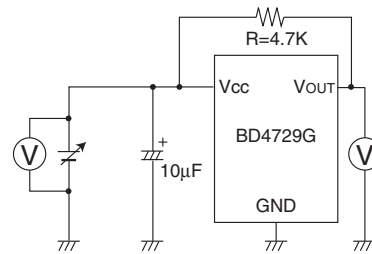
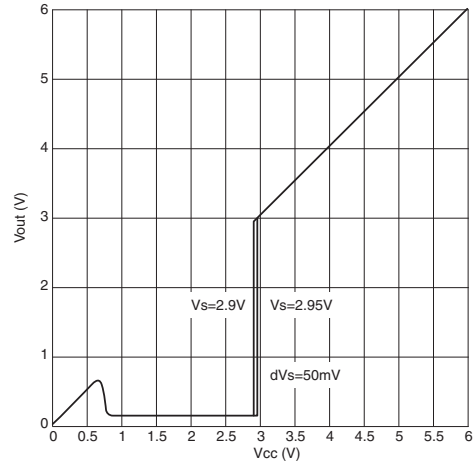

Operating limit voltage

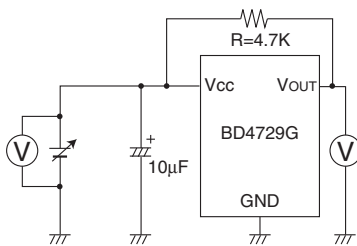
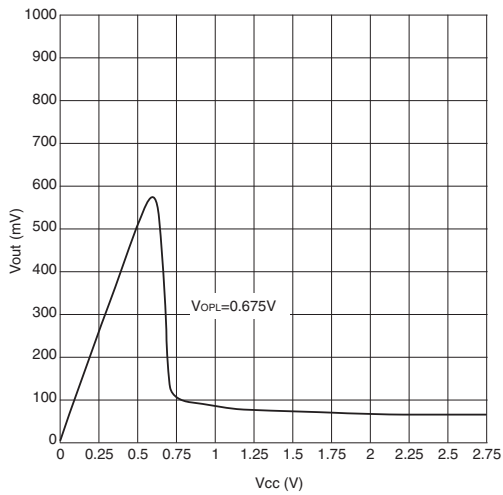

'L' output current

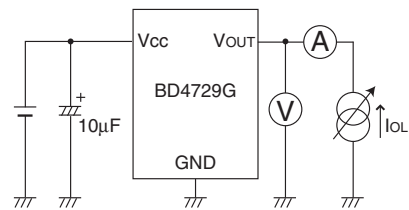
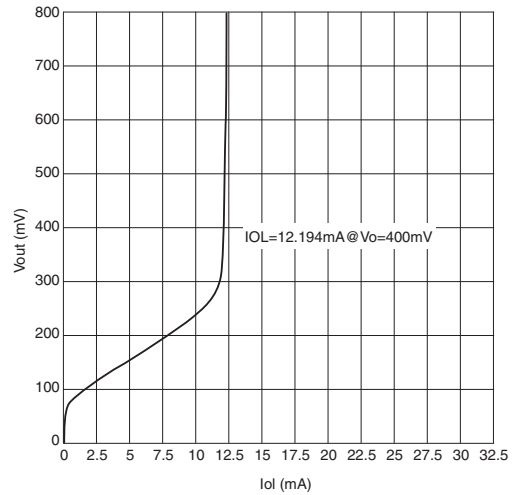

● Setting of the RESET signal delay time

Delay time can be set by capacitor C_L and resistance R_L connected to the output pin as shown below. C_L is charged by R_L when V_{CC} is rising. The delay time caused by charging is determined by the time constant of C_L , R_L and the threshold voltage of RESET pin. RESET IC discharges C_L forcibly when V_{CC} is falling. The delay time of RESET signal is determined by adding the delay time of single RESET IC to each time.

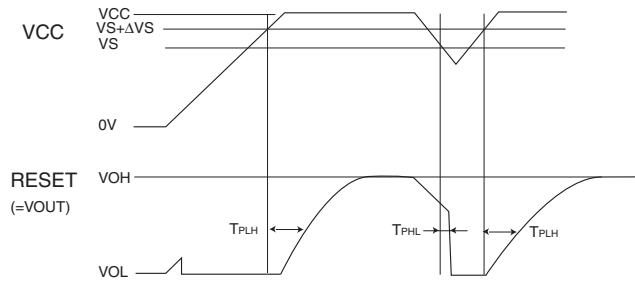
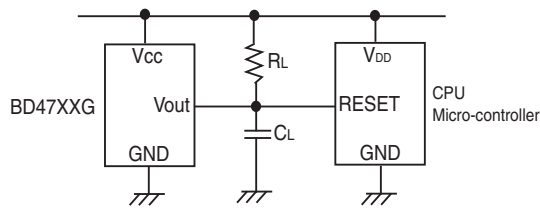

Part number and Marking of samples

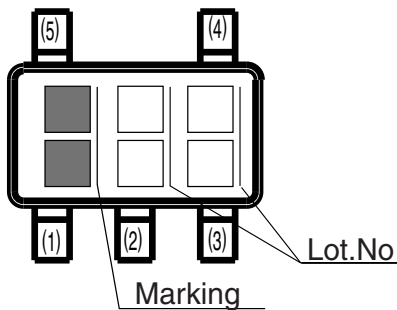

Marking	Voltage	Part No.	Marking	Voltage	Part No.	Marking	Voltage	Part No.
BA	1.9V	BD4719	BK	2.9V	BD4729	BU	3.9V	BD4739
BB	2.0V	BD4720	BL	3.0V	BD4730	BV	4.0V	BD4740
BC	2.1V	BD4721	BM	3.1V	BD4731	BW	4.1V	BD4741
BD	2.2V	BD4722	BN	3.2V	BD4732	BX	4.2V	BD4742
BE	2.3V	BD4723	B4	3.3V	BD4733	BY	4.3V	BD4743
BF	2.4V	BD4724	BP	3.4V	BD4734	BZ	4.4V	BD4744
BG	2.5V	BD4725	BQ	3.5V	BD4735	B1	4.5V	BD4745
BH	2.6V	BD4726	BR	3.6V	BD4736	B2	4.6V	BD4746
B3	2.7V	BD4727	BS	3.7V	BD4737			
BJ	2.8V	BD4728	BT	3.8V	BD4738			

Notes

- No technical content pages of this document may be reproduced in any form or transmitted by any means without prior permission of ROHM CO.,LTD.
- The contents described herein are subject to change without notice. The specifications for the product described in this document are for reference only. Upon actual use, therefore, please request that specifications to be separately delivered.
- Application circuit diagrams and circuit constants contained herein are shown as examples of standard use and operation. Please pay careful attention to the peripheral conditions when designing circuits and deciding upon circuit constants in the set.
- Any data, including, but not limited to application circuit diagrams information, described herein are intended only as illustrations of such devices and not as the specifications for such devices. ROHM CO.,LTD. disclaims any warranty that any use of such devices shall be free from infringement of any third party's intellectual property rights or other proprietary rights, and further, assumes no liability of whatsoever nature in the event of any such infringement, or arising from or connected with or related to the use of such devices.
- Upon the sale of any such devices, other than for buyer's right to use such devices itself, resell or otherwise dispose of the same, no express or implied right or license to practice or commercially exploit any intellectual property rights or other proprietary rights owned or controlled by ROHM CO., LTD. is granted to any such buyer.
- Products listed in this document use silicon as a basic material.
Products listed in this document are no antiradiation design.

The products listed in this document are designed to be used with ordinary electronic equipment or devices (such as audio visual equipment, office-automation equipment, communications devices, electrical appliances and electronic toys).

Should you intend to use these products with equipment or devices which require an extremely high level of reliability and the malfunction of which would directly endanger human life (such as medical instruments, transportation equipment, aerospace machinery, nuclear-reactor controllers, fuel controllers and other safety devices), please be sure to consult with our sales representative in advance.

About Export Control Order in Japan

Products described herein are the objects of controlled goods in Annex 1 (Item 16) of Export Trade Control Order in Japan.

In case of export from Japan, please confirm if it applies to "objective" criteria or an "informed" (by MITI clause) on the basis of "catch all controls for Non-Proliferation of Weapons of Mass Destruction.